



# general surgery



Ich bin sehr stolz, Ihnen den neuen  
RZ-Medizintechnik GmbH Katalog für die Allgemein-Chirurgie  
vorzustellen.

Dieser Katalog beinhaltet zusätzlich zu den Standard - Instrumenten  
auch spezielle Instrumente für die verschiedenen Disziplinen  
der Chirurgie.

In Zusammenarbeit mit unseren Kunden können wir auch neue  
Instrumente für neue Operationstechniken entwickeln.

RZ-Medizintechnik GmbH ist ein Familienbetrieb und wurde  
1994 in Tuttlingen gegründet.

Im Jahr 1997 wurden wir zertifiziert nach ISO 9001, EN46001  
in Verbindung mit dem Medizinprodukte Gesetz 93/42 EWG  
Anhang II für chirurgische Instrumente und Orthopädische  
Implantate.

Meine Firma ist deshalb qualifiziert und autorisiert, unsere  
Produkte mit dem CE-Zeichen zu versehen.

Meine Mitarbeiter und ich tun alles erdenklich Mögliche, um Sie  
zufriedenzustellen.

I am very proud to present the new

RZ-Medizintechnik GmbH catalogue for general surgery.

This catalogue, in addition to standard instruments, also con-  
tains specialty instruments for various chapters of surgery.

In association with our customers, we can, if instructed, deve-  
lop new patterns of instruments for new emerging operating  
techniques.

RZ-Medizintechnik GmbH which is a family owned business,  
was founded in Tuttlingen, Germany, in 1994.

In 1997 we became fully qualified to the ISO 9001 and  
EN 46001 control systems allied to the E U Medical Directive  
93/42 EEC Annex II for surgical instruments and orthopaedic  
implants. My company is therefore fully qualified and authorised  
to C E Mark our instruments.

Please rest assured that my staff and I aim to satisfy all your  
requirements to the highest standard.



Rainer Zubrod, Geschäftsführer bei RZ-Medizintechnik GmbH, kümmert sich persönlich um das Tagesgeschäft in der Firma. Herr Zubrod arbeitet seit vielen Jahren in der Medizinbranche und bringt große Erfahrung und Wissen in RZ-Medizintechnik GmbH ein.

Rainer Zubrod, managing director in RZ-Medizintechnik GmbH, is personally responsible for the day to day operations of the company. Mr. Zubrod has worked in the medical industry for many years, bringing a great deal of experience and expertise to RZ-Medizintechnik GmbH.



Erstklassiges Rohmaterial, modernste Maschinen und hochqualifizierte Instrumentenmacher garantieren ein gleichbleibend hohes Qualitätsniveau bei allen RZ-Instrumenten.

First quality raw material, sophisticated machines and qualified technical personel guarantee a constant high quality level of all RZ-instruments.





Im Jahr 1997 wurden wir zertifiziert nach ISO 9001, EN46001 in Verbindung mit dem Medizinprodukte Gesetz 93/42 EWG Anhang II für chirurgische Instrumente und orthopädische Implantate.

In 1997 we became fully qualified to the ISO. 9001 and EN.46001 control systems allied to the E.U. Medical Directive 93/42 EEC Annex II for surgical instruments and orthopaedic implants.

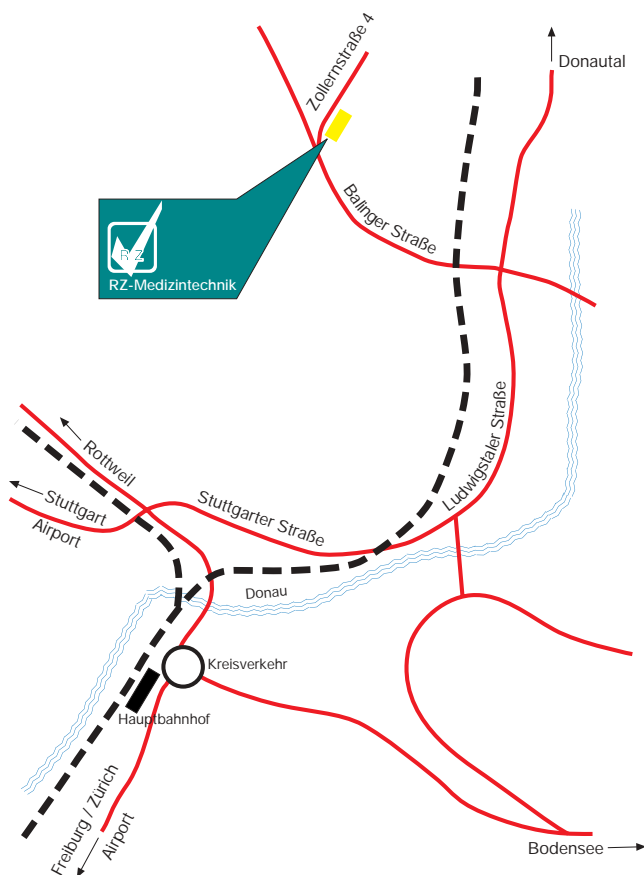

**So finden Sie uns:**  
 Sie sind uns immer willkommen, wenn Sie uns besuchen wollen. Tuttlingen liegt verkehrsgünstig zwischen Stuttgart, Zürich, Freiburg und dem Bodensee.

**How to find us:**  
 We would like welcome you at any time on a visit in our company. Tuttlingen is conveniently located between Stuttgart, Zürich, Freiburg and the Lake Constance.



**1** Diagnostik  
Diagnostics  
2-9



Siehe Spezialkatalog / See special catalogue

**2** Skalpell  
Scalpels  
10-17



**3** Scheren  
Scissors  
18-49



**4** Pinzetten  
Forceps  
50-65



**5** Arterienklemmen,  
Tuchklemmen  
Hemostatic and  
Towel Forceps  
66-99

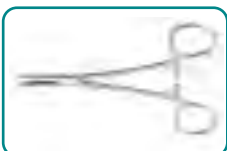

**6** Tupfer- und  
Kornzangen  
Cotton Swab  
Forceps etc.  
100-103



**7** Sonden,  
Watteträger  
Probes,  
Applicators  
104-106



**8** Impfen,  
Punktion, Saugen  
Vaccination,  
Puncture, Suction  
107-117



**9** Wundhaken, und  
Wundsperrer  
Retractors  
118-161



**10** Naht  
Suture  
162-193

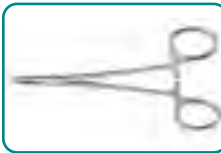

**11** Knochenchirurgie  
Bone Surgery  
194-199



Siehe Spezialkatalog / See special catalogue

**12** Darm, Magen,  
Mastdarm  
Intestines,  
Stomach, Rectum  
200-210



**13** Leber, Galle, Niere  
Liver, Gall, Kidney  
211-214



**14** Blase, Urologie  
Bladder, Urology  
215-217



Siehe Spezialkatalog / See special catalogue

**15** Gynäkologie  
Gynecology  
218-244



**16** Geburtshilfe  
Obstetrics  
245-247



**17** Dermatologie  
Dermatology  
248-249



Siehe Spezialkatalog / See special catalogue

**18** Instrumentenpflege  
Maintenance of  
Instruments  
250-253



Siehe Spezialkatalog / See special catalogue





1



**Taylor**  
17.0 cm, 6 3/4"  
100-111-170  
20.0 cm, 8 "  
100-111-200



**Traube**  
16.0 cm, 6 1/4"  
100-112-160



**Babinsky**  
22.0 cm, 8 5/8"  
100-110-220



**Troemner**  
24.0 cm, 9 1/2"  
100-113-240



**Dejerine**  
20.0 cm, 8"  
100-114-200



**Dejerine**  
20.0 cm, 8"  
100-115-200



**Berliner**  
17.0 cm 6 3/4"  
100-116-170

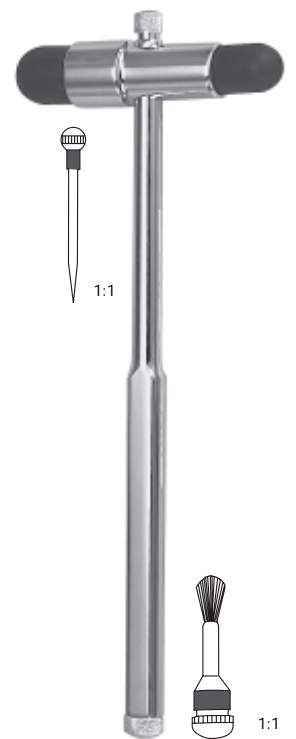

**Buck**  
18.0 cm, 7"  
100-117-180



1



**Moeltgen**  
Winkelmesser  
Goniometer  
100-412-000



**Wartenberg**  
Nadelrad / Pinwheel  
19.0 cm, 7 1/2  
100-416-190



**Aly**  
17.0 cm, 6 3/4"  
100-417-170



**Weber**  
9.0 cm, 3 1/2"  
100-411-000



**Collin**  
Dynamometer

Erwachsene, Adults  
100-012-001

Kinder, Children  
100-012-002

Metall-Meßstäbe, rostfrei, cm/inch  
Rulers, metal, stainless, cm/inch



10.0 cm, 4"	100-418-100
20.0 cm, 8"	100-418-200
30.0 cm, 12"	100-418-300
50.0 cm, 20"	100-418-500



15.0 cm, 6" 100-422-150



1



**Pinard**  
aus Aluminium  
of aluminium  
100-109-150

**Pinard**  
aus Plastik  
of plastic  
100-109-180



**Baby Duplex**  
Bruststück: ø 40 mm  
chest piece: ø 40 mm  
100-109-000



**Duplex**  
Bruststück: ø 45 mm  
chest piece: ø 45 mm  
100-108-000



**Duplex Color**  
Bruststück: ø 45 mm  
chest piece: ø 45 mm

Rot, red	100-108-001
Blau, blue	100-108-002
Grün, green	100-108-003
Gold, gold	100-108-004





1



**Bowles**  
Bruststück: ø 40 mm  
chest piece: ø 40 mm  
100-105-000



**Cardiophon**  
Bruststück: ø 45 mm  
chest piece: ø 45 mm  
100-110-000



**Ford**  
Bruststück: ø 26 mm  
chest piece: ø 26 mm  
100-106-000



<b>Anestophon</b>	Silber, silver	100-106-001
Bruststück: ø 48 mm	Gold, gold	100-106-002
chest piece: ø 48 mm	Grün, green	100-106-003
	Blau, blue	100-106-004
	Rot, red	100-106-005



1



**Minimus II**

Einhand-Modell mit Einschlauch Anschluß  
One-hand model with one tube connection  
100-007-000



**Precisa N**

Einhand-Modell mit Zweischlauch Anschluß  
One-hand model with two tube connection  
100-108-000



**Babyphon**

Komplettes Set für Neugeborene, Säuglinge  
und Kinder. Inklusiv drei Manschetten und  
Manometer in Kunstledertasche

Complete set for newborn, infants and  
children. Including three velcro cuff and  
manometer in leatherette case  
100-109-100



**Diplomat**

Quecksilbergerät in Metalltui  
Mercury apparatus in metal case  
100-002-000



1



**Big Ben**  
Wandmodell mit Velcromanschette  
Wall model with velcro cuff  
100-107-100



**Global**  
Wandmodell mit Velcromanschette  
Wall model with velcro cuff  
100-010-000



**Oto-Ophthalmoscope Set**  
100-046-000  
Otoskop mit drei Ohrtrichtern, Ophthalmoskop,  
Nasenspekulum, Lampenträger und zwei  
Kehlkopfspiegeln, ein Griff 2.5V Standardbeleuchtung,  
in Etui  
  
Otoscope with three ear specula, ophthalmoscope, nasal  
specula, lamp holder and two laryngeal mirrors,  
one handle 2.5V standard illumination, in case



**Ophthalmoskop Set**  
110V 100-045-000      220V 100-045-001  
Ophthalmoskop mit Fiber-Optik und  
Halogenbeleuchtung, stufenlose Fokussiereinrichtung,  
eine Beleuchtungslinse, aufladbarer Metallgriff,  
in Etui  
  
Ophthalmoscope with fiber-optic and halogen  
illumination, stepless focusing, one illumination lens,  
rechargeable metal handle, in case



1



**Otoscope Set**

110V 100-039-000      220V 100-039-001

Otoskop mit Fiber-Optik und Halogenbeleuchtung, vier wiederverwendbaren und zehn Einmal-Ohrtrichtern, Operationslupe (3.5fach), aufladbarer Metallgriff 3.5V, in Etui

Otoscope with fiber optic and halogen illumination, four reusable and ten disposable ear specula, magnifying lense (3.5fold), rechargeable metal handle 3.5V, in case



**Oto-Rhinoscope Set**

110V 100-040-000      220V 100-040-001

Otoskop mit Fiber-Optik und Halogenbeleuchtung, vier wiederverwendbare und zehn Einmal-Ohrtrichter, Nasenspekulum, Spatelhalter, Operationslupe (3.5fach), aufladbarer Metallgriff 3.5V in Etui

Otoscope with fiber optic and halogen illumination, four reusable and ten disposable ear specula, nasal specula, tongue blade holder, magnifying lense (3.5fold), rechargeable metal handle 3.5V, in case



**De Luxe Set**

110V 100-041-000      220V 100-041-001

Otoskop mit Fiber-Optik und Halogenbeleuchtung, vier wiederverwendbare und zehn Einmal-Ohrtrichter, Ophthalmoskop, Nasenspekulum, Spatelhalter, zwei Kehlkopfspiegel, Lampenträger, aufladbarer Metallgriff 3.5V, in Etui

Otoscope with fiber optic and halogen illumination, four reusable and ten disposable ear specula, ophthalmoscope, nasal speculum, tongue blade holder, two laryngeal mirrors, lamp holder, rechargeable metal handle 3.5V, in case



**Laryngoscopy Set**  
100-213-100

Griff, groß, ohne Batterien, drei McIntosh Spatel Fig. 1,2 und 3 mit konventioneller Beleuchtung, mit zwei Halogen Ersatzlampen, in Kunstleder Etui

Handle, large without batteries, three McIntosh blades fig. 1,2 and 3 with standard illumination, with two spare halogen bulbs, in pouch bag



100-102-006  
Ersatzbirne  
spare bulb

**Clar**  
Stirnlampe, Head light  
**100-102-000**

Stirnlampe, 6 Volt, mit verstellbarem Gelenk, weißes Kunststoff-Kopfband und Schaumstoffpolster, mit Kabel für den Anschluß an Transformator (100-103-001)

Head Light, 6 Volt, with adjustable joint, white celluloid head band with foam rubber pad, cord with plugs for transformer (100-103-001)

**100-102-001**  
weißes Kunststoff-Kopfband, allein (für 100-102-000)  
white celluloid head band, only (for 100-102-000)

**100-102-002**  
Ersatzspiegel, allein (für 100-102-000)  
Spare mirror, only (for 100-102-000)



100-104-006  
Ersatzbirne  
spare bulb

**Clar 55**  
Stirnlampe, Head light  
**100-104-000**

Stirnlampe, 6 Volt, mit verstellbarem Gelenk, weißes Kunststoff-Kopfband und Schaumstoffpolster, mit Kabel für den Anschluß an Transformator (100-103-001)

Head Light, 6 Volt, with adjustable joint, white celluloid head band with foam rubber pad, cord with plugs for transformer (100-103-001)

**100-104-001**  
weißes Kunststoff-Kopfband, allein (für 100-104-000)  
white celluloid head band, only (for 100-104-000)

**100-104-002**  
Ersatzspiegel, allein (für 100-104-000)  
Spare mirror, only (for 100-104-000)



**100-110-010**  
**Ziegler**

Ziegler Stirnspiegel ø 90 mm mit weißem Stirnband  
Ziegler head mirror ø 90 mm with white head band

**100-100-020**  
Ziegler Stirnspiegel ø 90 mm mit schwarzem Stirnband  
Ziegler head mirror ø 90 mm with black head band

**100-100-000**  
Ziegler Stirnspiegel, allein ø 100 mm  
Ziegler head mirror, only ø 100 mm

**100-100-002**  
Stirnband, schwarz, allein  
Head band, black, only

**100-100-003**  
Stirnband, weiß, allein  
Head band, white, only



**100-103-001**  
Klein-Transformator, für 220 Volt Wechselstrom,  
Steckbuchse für Schwachstrom  
Mini-Transformer Unit for 220 volts alternating current,  
outlet for low voltage current



RZ-Medizintechnik Skalpellklingen sind zu 100 Stück in einem Karton verpackt. Nummer und Abbildung der Klingen sind auf den Karton gedruckt. Alle Klingen sind gammabestrahlt (2.5 M-RAD).

RZ-Medizintechnik scalpel blades come in packages of 100 pieces. Article number and illustration of the blade is shown on the package. All blades are sterilized by gamma radiation (2.5 M-RAD).

2



1:1

Fig. 10  
110-201-010



1:1

Fig. 11  
110-201-011



1:1

Fig. 12  
110-201-012

doppelschneidig  
double cutting edge

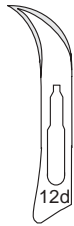

1:1

Fig. 12d  
110-201-112

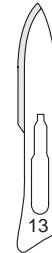

1:1

Fig. 13  
110-201-013



1:1

Fig. 15  
110-201-015



1:1

Fig. 15c  
110-201-115



Nr. 3  
No. 3  
13.0 cm, 5"  
110-110-003



Nr. 3, graduiert  
No. 3, graduated  
13.0 cm, 5"  
110-114-003



Nr. 3L  
No. 3L  
21.0 cm, 8 1/4"  
110-116-033



Nr. 7  
No. 7  
16.5 cm, 6 1/2"  
110-130-077

gleich wie  
Nr. 5  
Same as  
No. 5



Nr. 7K  
No. 7K  
13.0 cm, 5"  
110-130-007



RZ-Medizintechnik Skalpellklingen sind zu 100 Stück in einem Karton verpackt. Nummer und Abbildung der Klingen sind auf den Karton gedruckt. Alle Klingen sind gammabestrahlt (2.5 M-RAD).

RZ-Medizintechnik scalpel blades come in packages of 100 pieces. Article number and illustration of the blade is shown on the package. All blades are sterilized by gamma radiation (2.5 M-RAD).

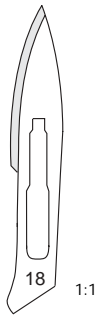

Fig. 18  
110-201-018

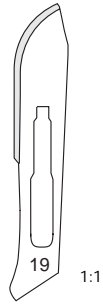

Fig. 19  
110-201-019

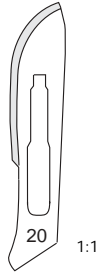

Fig. 20  
110-201-020

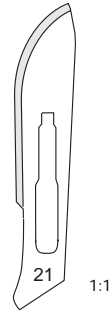

Fig. 21  
110-201-021

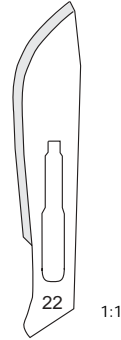

Fig. 22  
110-201-022

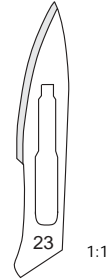

Fig. 23  
110-201-023

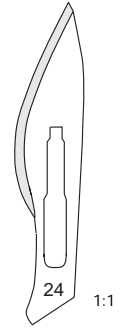

Fig. 24  
110-201-024

2



Nr. 4  
No. 4  
13.5 cm, 5 3/8"  
110-140-004



Nr. 4L  
No. 4L  
21.0 cm, 8 1/4"  
110-144-004



Nr. 8  
No. 8  
13.5 cm, 5 3/8"  
110-146-008



Nr. 9  
No. 9  
14.5 cm, 5 3/4"  
110-146-009

2



**Operation**  
17.0 cm, 6 3/4"

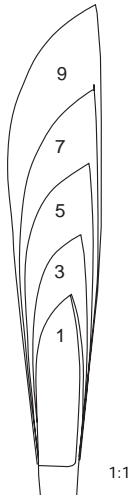

Fig. 1 110-005-001  
Fig. 3 110-005-003  
Fig. 5 110-005-005  
Fig. 7 110-005-007  
Fig. 9 110-005-009

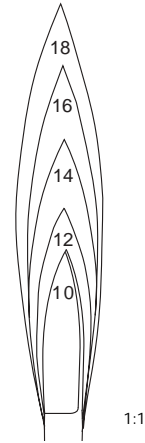

Fig. 10 110-005-010  
Fig. 12 110-005-012  
Fig. 14 110-005-014  
Fig. 16 110-005-016  
Fig. 18 110-005-018



**Collin**  
16.0 cm, 6 1/4"



Fig. 1 110-006-001  
Fig. 2 110-006-002  
Fig. 3 110-006-003

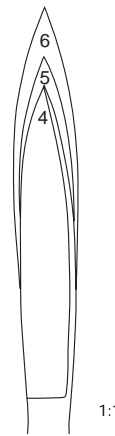

Fig. 4 110-006-004  
Fig. 5 110-006-005  
Fig. 6 110-006-006





Dissecting  
17.0 cm 6 3/4"

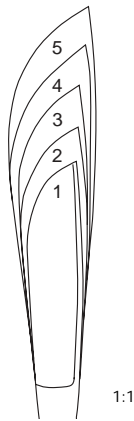

Fig. 1 110-010-001  
Fig. 2 110-010-002  
Fig. 3 110-010-003  
Fig. 4 110-010-004  
Fig. 5 110-010-005

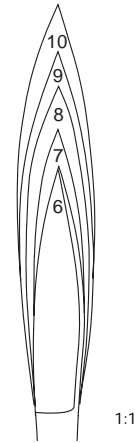

Fig. 6 110-010-006  
Fig. 7 110-010-007  
Fig. 8 110-010-008  
Fig. 9 110-010-009  
Fig. 10 110-010-010



Dieffenbach  
16.0 cm, 6 1/4"



Fig. 1 110-015-001  
Fig. 2 110-015-002  
Fig. 3 110-015-003  
Fig. 4 110-015-004  
Fig. 5 110-015-005

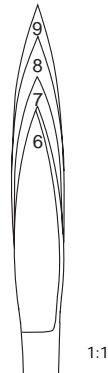

Fig. 6 110-015-006  
Fig. 7 110-015-007  
Fig. 8 110-015-008  
Fig. 9 110-015-009

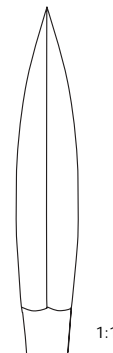

Fig. 15 110-015-015

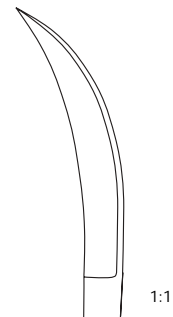
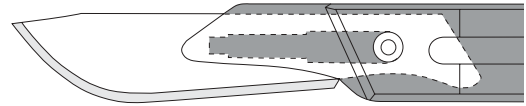

Fig. 16 110-015-016



**Steril, sterile**

Einmal-Skalpelle mit Kunststoffgriff, in Packungen zu 10 Skalpelln  
Disposable scalpels with plastic handle, in boxes of 10 scalpels



doppelschneidig  
double cutting edge

2



Fig. 10 110-220-010    Fig. 11 110-220-011    Fig. 11s 110-220-111    Fig. 12 110-220-012    Fig. 12d 110-220-112    Fig. 13 110-220-013    Fig. 15 110-220-015    Fig. 15c 110-220-115



Fig. 18 110-220-018    Fig. 19 110-220-019    Fig. 20 110-220-020    Fig. 21 110-220-021    Fig. 22 110-220-022    Fig. 23 110-220-023    Fig. 24 110-220-024    Fig. 25 110-220-025

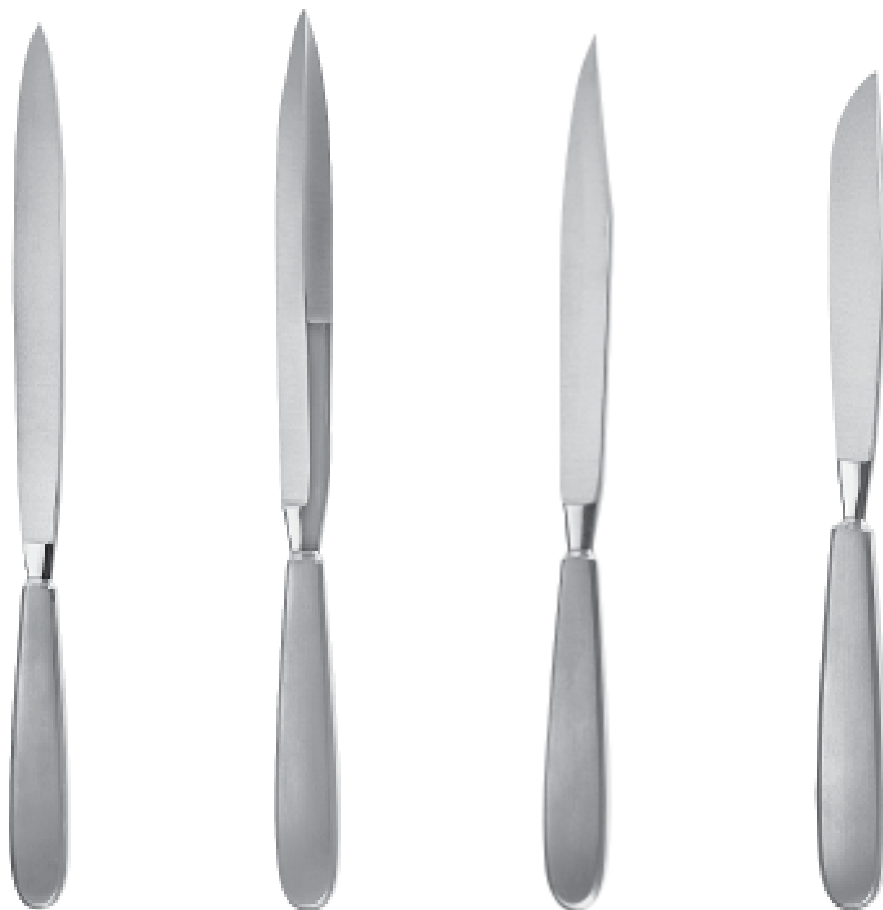

Schnittlängen Lengths of blades	Collin	Catlin	Liston	Langenbeck
12.0 cm, 4 3/4"				110-020-012
13.0 cm, 5"	110-014-013			110-020-013
16.0 cm, 6 1/4"	110-014-016	110-018-016		
17.0 cm, 6 3/4"			110-019-017	
19.0 cm, 7 1/2"	110-014-019	110-018-019		
20.0 cm, 8"			110-019-020	
22.0 cm, 8 5/8"	110-014-022	110-018-022	110-019-022	
28.0 cm, 11"	110-014-028			



**Walb** Organmesser kommen hauptsächlich in der Pathologie zum Einsatz. Mit ihnen werden Körperteile sowie Organe durchtrennt. Zur guten Handhabung haben **Walb** Organmesser einen schweren Griff, welcher mit Holzschalen ausgestattet ist.

**Walb** organ knives are used in pathology. With those knives, body parts and organs will be cut. For better handling the **Walb** organ knives have a heavy wooden handle.

Mit Hirnmessern nach **Virchow** werden in der Pathologie Hirnteile durchtrennt.

**Virchow** Hirnmesser besitzen stets einen Hohlgriff, und sind extrem leicht. Die Schneide ist besonders lang und dünn.

**Virchow** brain knives are used in pathology to cut parts of the brain. **Virchow** brain knives have an extremely light hollow handle. The blades are especially long and thin.

**Resektions-** und **Knorpelmesser** werden zum Resezieren, sowie zum Durchtrennen von Extremitäten verwendet. Da diese Körperteile nicht sehr voluminös sind, besitzen beide Messer relativ kurze Schneiden.

**Resection** and **Cartilage knives** are used for resection and cutting of small parts of the body. These parts are normally not very big, therefore the cutting blades are relatively short.

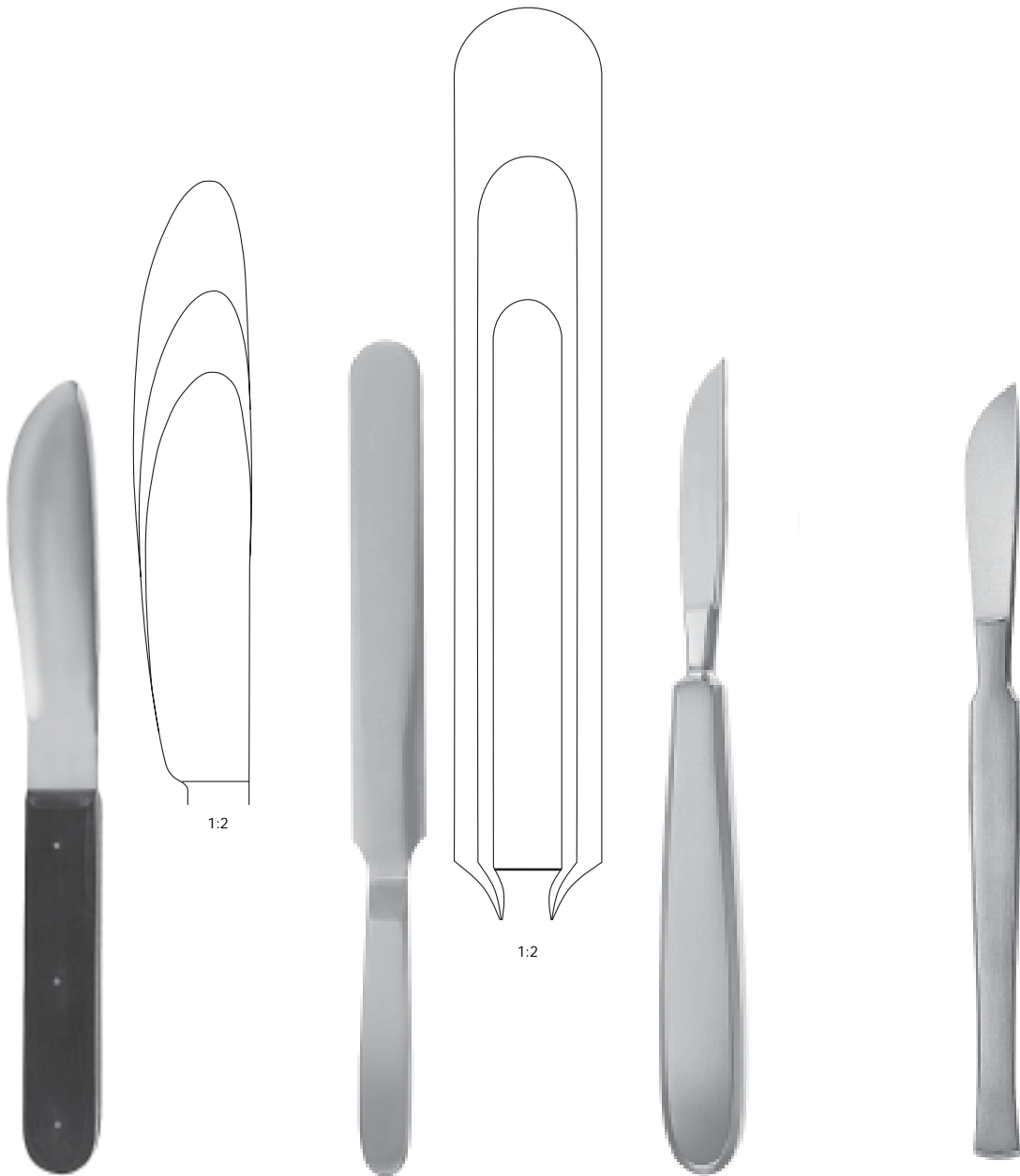

**Walb**

Schneide blade	
11.0 cm, 4 1/2"	<b>110-050-110</b>
14.0 cm, 5 1/2"	<b>110-050-140</b>
17.0 cm, 6 3/4"	<b>110-050-170</b>

**Virchow**

Schneide blade	
16.0 cm, 6 1/4"	<b>110-060-160</b>
20.0 cm, 8"	<b>110-060-200</b>
24.0 cm, 9 1/2"	<b>110-060-240</b>

**Langenbeck**

Metalheft metal handle	
18.0 cm, 7"	<b>110-026-055</b>

**Cartilage**

mit Schaberende with dissector end	
17.5 cm, 6 5/8"	<b>110-030-175</b>

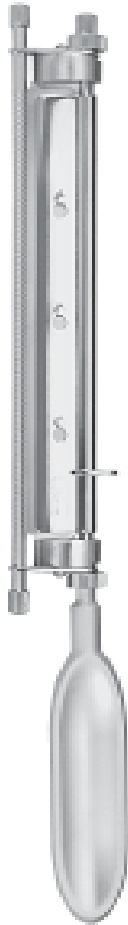

**Braithwaite**  
30.0 cm, 12"  
110-098-305

Ersatzklinge, Spare blade  
110-098-399



**Silver**  
19.0 cm, 7 1/2"  
110-096-019

Ersatzklinge, Spare blade  
110-096-119

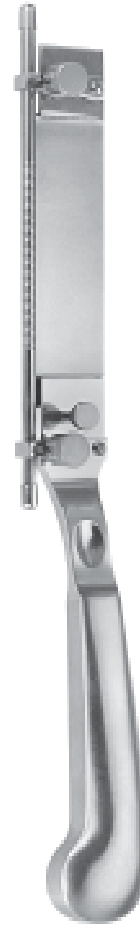

**Schink**  
30.0 cm, 12"  
110-090-000

Ersatzklinge, Spare blade  
110-090-001

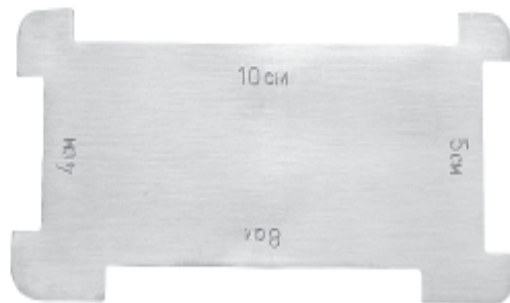

**Spannplatte**  
Skin straightening plate  
110-090-002

Auf speziellen Wunsch können wir auch sterile Ersatzklingen für die Dermatome liefern.  
On special request we can also supply sterile spare blades for the dermatomes.

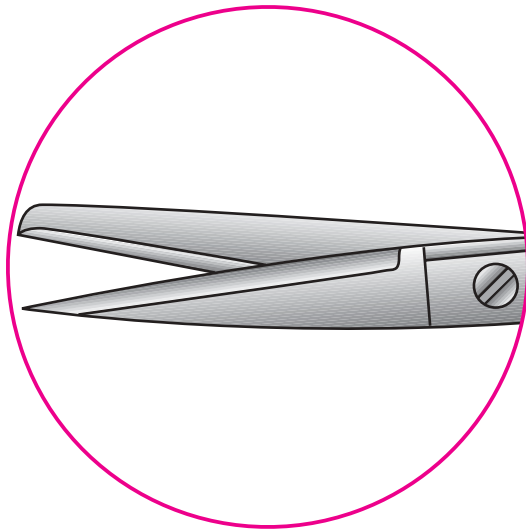

Alle Scheren mit RZ-Dur Cut Hartmetalleinlagen zeichnen sich durch eine über lange Zeit gleichmäßige, weiche und dauerhafte Schnittgenauigkeit aus. Alle Scheren mit Hartmetalleinlagen haben zur Kennzeichnung vergoldete Ringe und sind in unserem Katalog mit gelber Farbe unterlegt.

All scissors with RZ-Dur Cut tungsten carbide inserts are distinguished by a uniform, smooth and accuracy cutting. Scissors with tungsten carbide inserts are identified by gold-plated rings and adjusted in yellow color in our catalog.

3

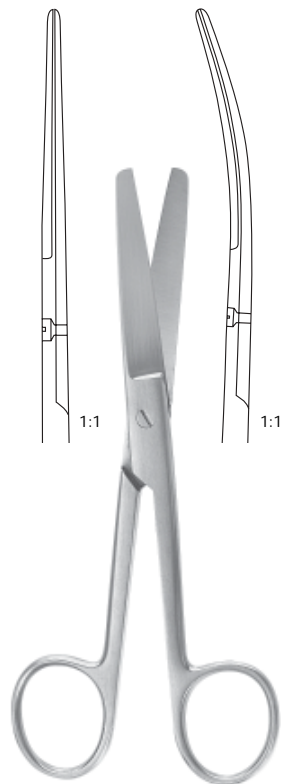

Fig.1

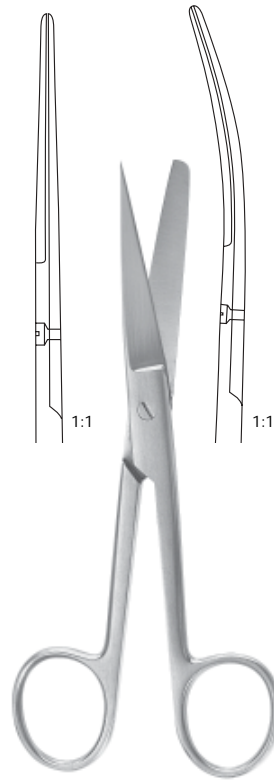

Fig.2

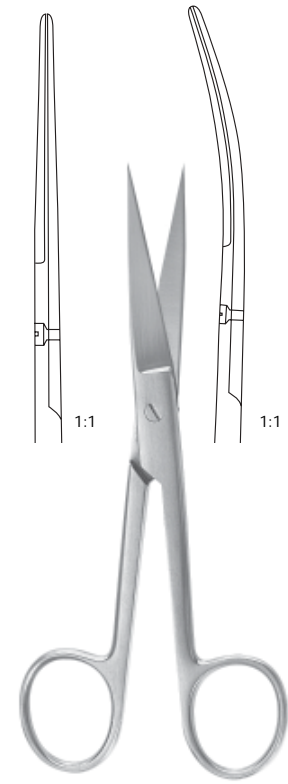
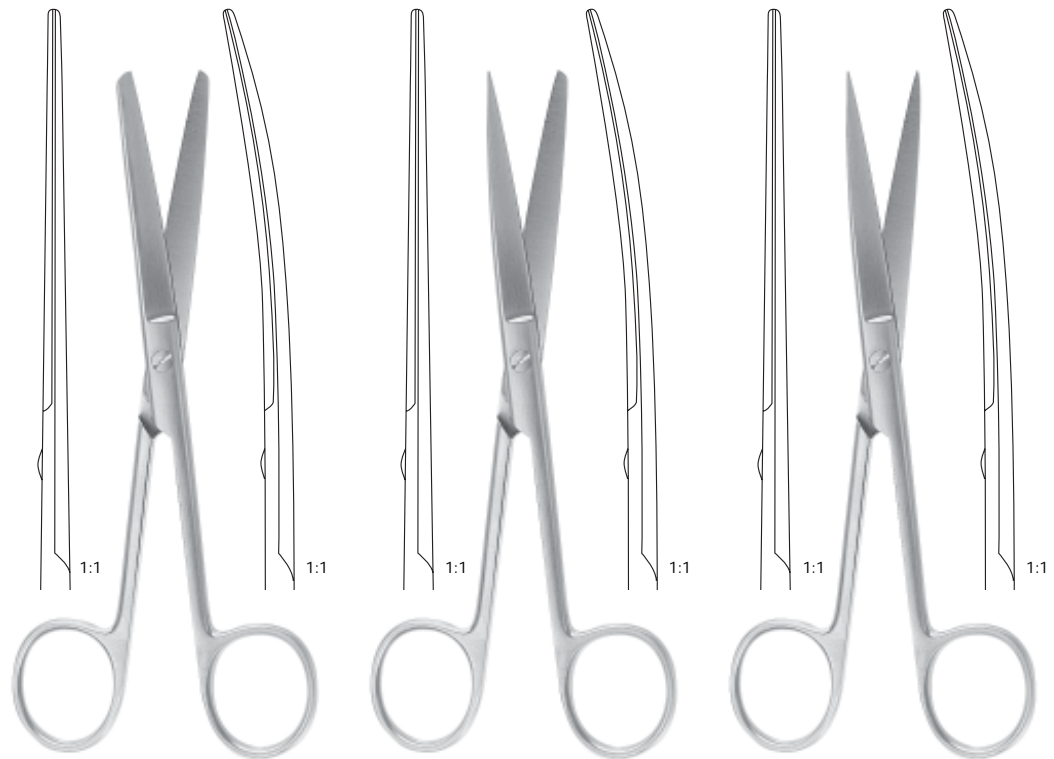
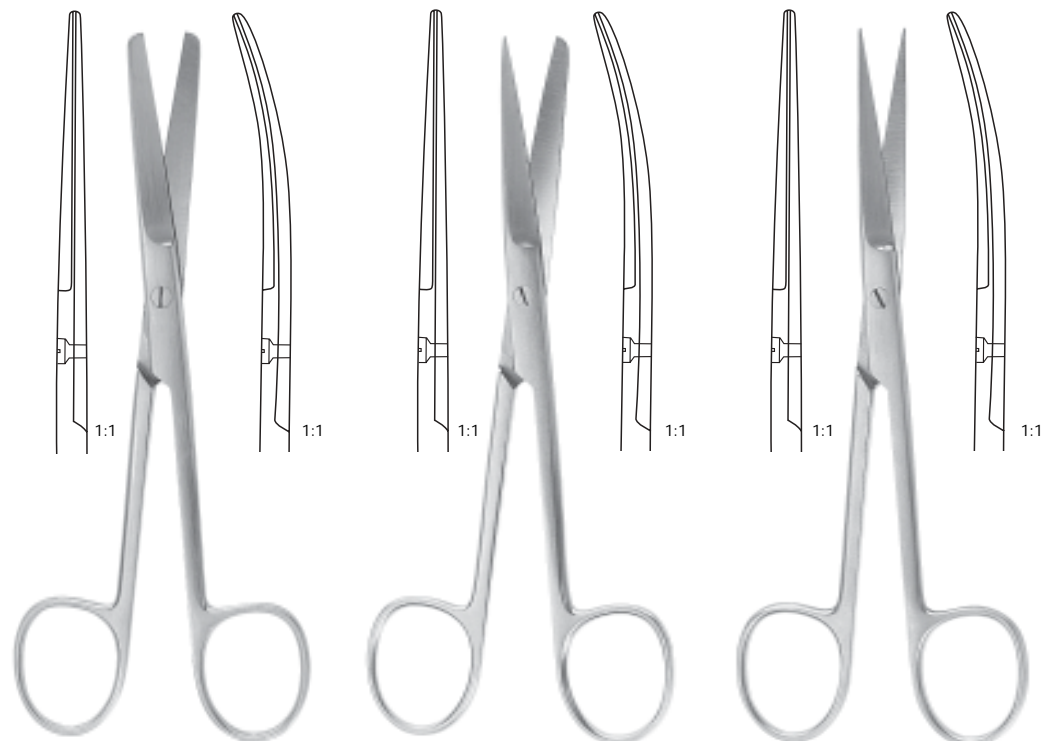

Fig.3

Standard	gerade straight	gebogen curved	gerade straight	gebogen curved	gerade straight	gebogen curved
10.5 cm, 4 1/4"	120-010-105	120-011-105	120-012-105	120-013-105	120-014-105	120-015-105
11.5 cm, 4 1/2"	120-010-115	120-011-115	120-012-115	120-013-115	120-014-115	120-015-115
13.0 cm, 5"	120-010-130	120-011-130	120-012-130	120-013-130	120-014-130	120-015-130
14.5 cm, 5 3/4"	120-010-145	120-011-145	120-012-145	120-013-145	120-014-145	120-015-145
14.5 cm, 5 3/4"	120-500-145	120-501-145	120-502-145	120-503-145	120-504-145	120-505-145
15.5 cm, 6"	120-010-155	120-011-155	120-012-155	120-013-155	120-014-155	120-015-155
16.5 cm, 6 1/2"	120-010-165	120-011-165	120-012-165	120-013-165	120-014-165	120-015-165
16.5 cm, 6 1/2"	120-500-165	120-501-165	120-502-165	120-503-165	120-504-165	120-505-165
17.5 cm, 6 5/8"	120-010-175	120-011-175	120-012-175	120-013-175	120-014-175	120-015-175
18.5 cm, 7 1/4"	120-010-185	120-011-185	120-012-185	120-013-185	120-014-185	120-015-185
18.5 cm, 7 1/4"	120-500-185	120-501-185	120-502-185	120-503-185	120-504-185	120-505-185
20.0 cm, 8"	120-010-200	120-011-200	120-012-200	120-013-200	120-014-200	120-015-200



Grazil	gerade straight	gebogen curved	gerade straight	gebogen curved	gerade straight	gebogen curved
13.0 cm, 5"	120-016-130	120-017-130	120-018-130	120-019-130	120-020-130	120-021-130
14.5 cm, 5 3/4"	120-016-145	120-017-145	120-018-145	120-019-145	120-020-145	120-021-145



Deaver	gerade straight	gebogen curved	gerade straight	gebogen curved	gerade straight	gebogen curved
12.0 cm, 4 3/4"	120-026-120	120-027-120	120-024-120	120-025-120	120-028-120	120-029-120
13.0 cm, 5"	120-026-130	120-027-130	120-024-130	120-025-130	120-028-130	120-029-130
14.5 cm, 5 3/4"	120-026-145	120-027-145	120-024-145	120-025-145	120-028-145	120-029-145

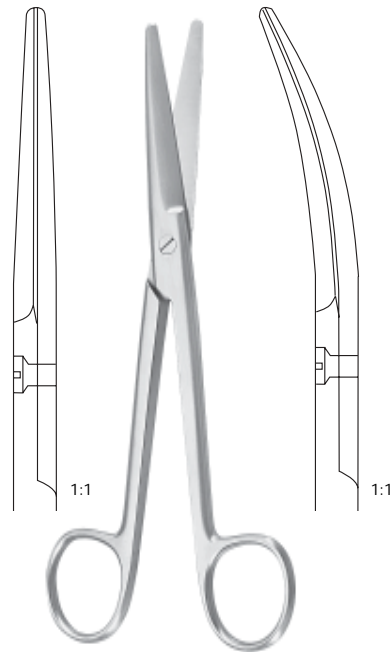

Mayo

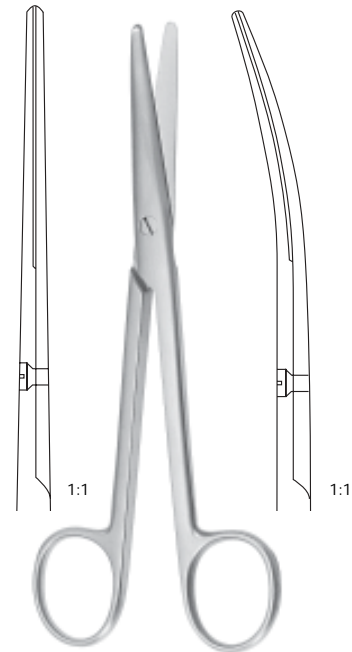

Mayo-Stille

	gerade straight	gebogen curved	gerade straight	gebogen curved
14.5 cm, 5 3/4"	120-030-145	120-031-145		
14.5 cm, 5 3/4"	120-506-145	120-507-145		
15.0 cm, 6"	120-030-150	120-031-150	120-036-150	120-037-150
15.0 cm, 6"			120-508-150	120-509-150
17.0 cm, 6 3/4"	120-030-170	120-031-170	120-036-170	120-037-170
17.0 cm, 6 3/4"	120-506-170	120-507-170	120-508-170	120-509-170
19.5 cm, 7 3/4"			120-036-195	120-037-195
21.0 cm, 8 1/4"			120-036-210	120-037-210
23.0 cm, 9"	120-030-230	120-031-230		
23.0 cm, 9"	120-506-230	120-507-230		
28.0 cm, 11"	120-030-280	120-031-280		

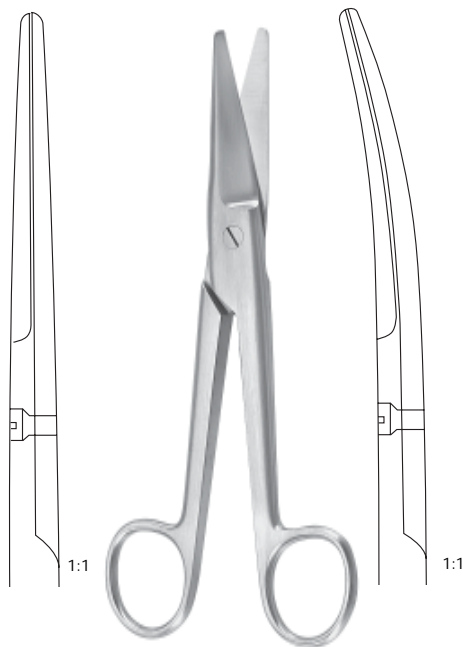

Mayo-Noble

gerade, straight  
17.0 cm, 6 3/4"  
120-048-170

gebogen, curved  
17.0 cm, 6 3/4"  
120-049-170

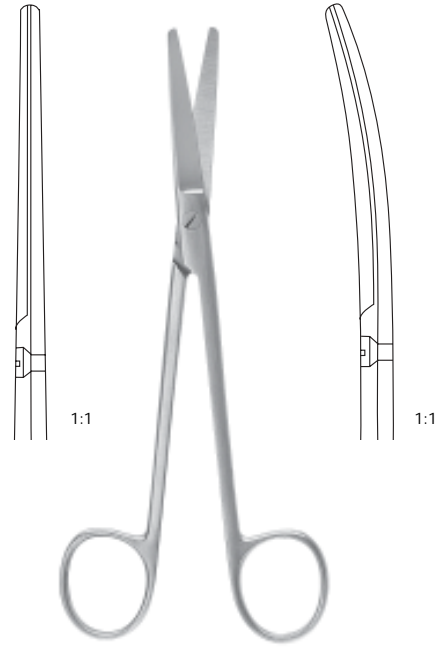

Mixer

gerade, straight  
15.5 cm, 6"  
120-050-155

gebogen, curved  
15.5 cm, 6"  
120-051-155





Inzisionsschere  
Incision scissors  
13.0 cm, 5"  
120-022-130  
14.5 cm, 5 3/4"  
120-022-145



Inzisionsschere  
Incision scissors  
16.5 cm, 6 1/2"  
120-023-165



Richter  
14.5 cm, 5 3/4"  
120-034-145



Fergusson  
16.5 cm, 6 1/2"  
120-035-165  
18.0 cm, 7"  
120-035-180

3



Lawson Tait  
12.5 cm, 5"  
120-236-125



	Kelly	
	gerade, straight	gebogen, curved
16.0 cm, 6 1/4"	120-046-160	120-047-160
18.0 cm, 7"	120-046-180	120-047-180



3



**Wertheim**  
19.5 cm, 7 3/4"  
120-053-195  
22.5 cm, 8 3/4"  
120-053-225



**Dubois**  
gerade, straight 27.0 cm, 10 5/8" 120-116-270  
gebogen, curved 27.0 cm, 10 5/8" 120-117-270



Sims	gerade straight	gerade straight	gerade straight	gebogen curved	gebogen curved	gebogen curved
20.0 cm, 8"	120-062-200	120-072-200	120-074-200	120-063-200	120-073-200	120-075-200
20.0 cm, 8"	120-532-200	120-534-200	120-536-200	120-533-200	120-535-200	120-537-200
23.0 cm, 9"	120-062-230	120-072-230	120-074-230	120-063-230	120-073-230	120-075-230
23.0 cm, 9"	120-532-230	120-534-230	120-536-230	120-533-230	120-535-230	120-537-230



Doyen	gerade, straight	gerade, straight	gebogen, curved	gerade, straight	gebogen, curved
16.0 cm, 6 1/4"	120-042-160	120-040-160	120-041-160		
17.5 cm, 6 5/8"				120-040-175	120-041-175

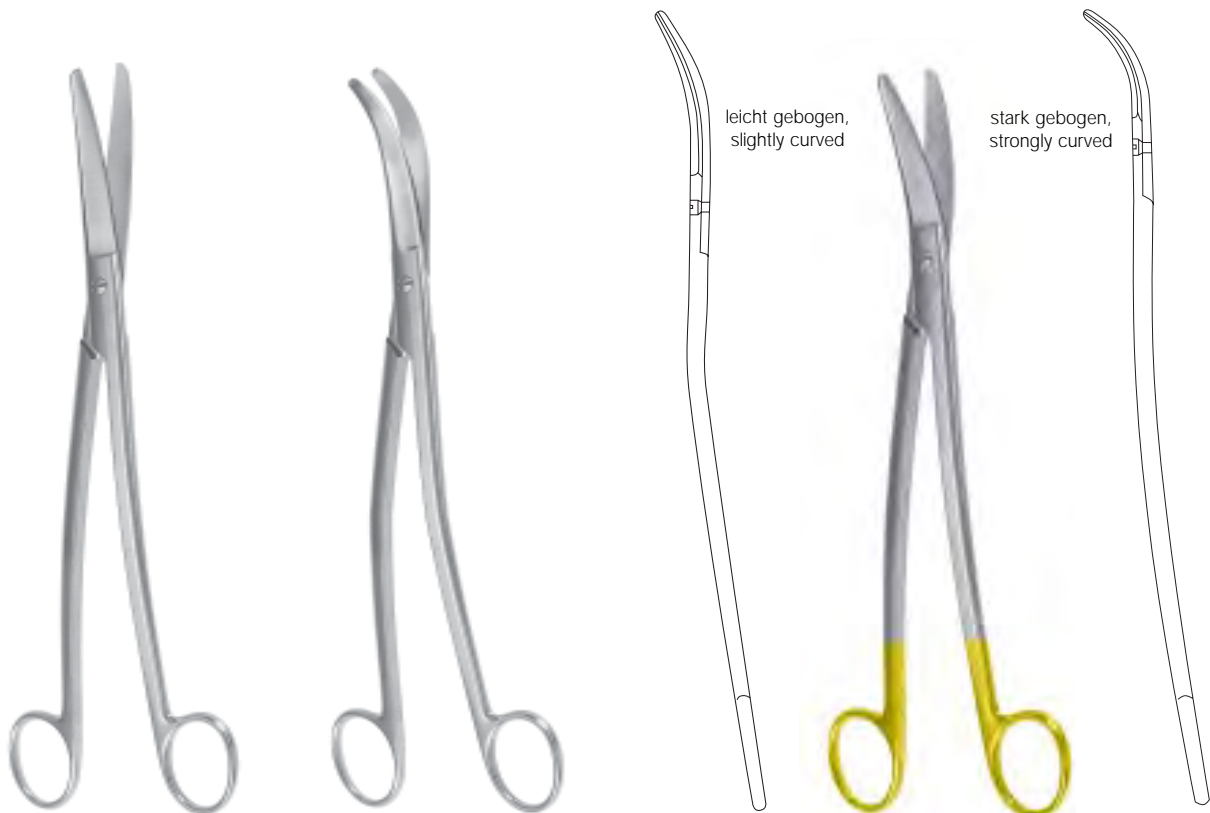

**Siebold**  
S-gebogen, S-curved  
24.0 cm, 9 1/2"  
120-061-240

**Bozemann**  
S-gebogen, S-curved  
22.0 cm, 8 3/4"  
120-061-220

25.5 cm, 10"  
**120-571-255**

**Hysterektomie**

25.0 cm, 9 3/4"  
**120-572-250**



3

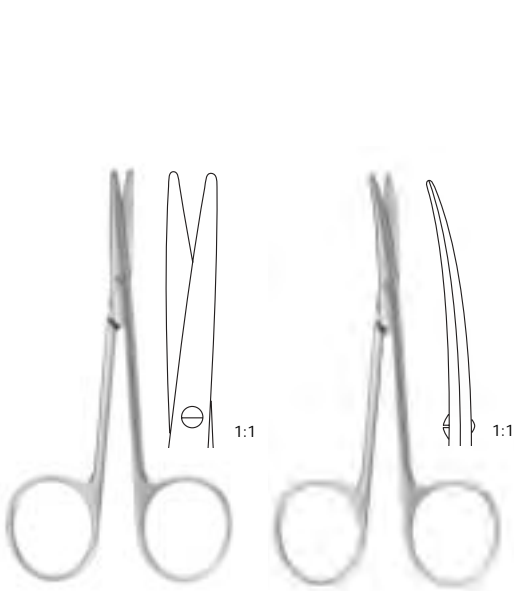

**Metzenbaum-Baby**  
Fig. 1  
11.5 cm, 4 1/2"  
gerade, straight  
120-110-115  
120-510-115

**Metzenbaum-Baby**  
Fig. 1  
11.5 cm, 4 1/2"  
gebogen, curved  
120-111-115  
120-511-115

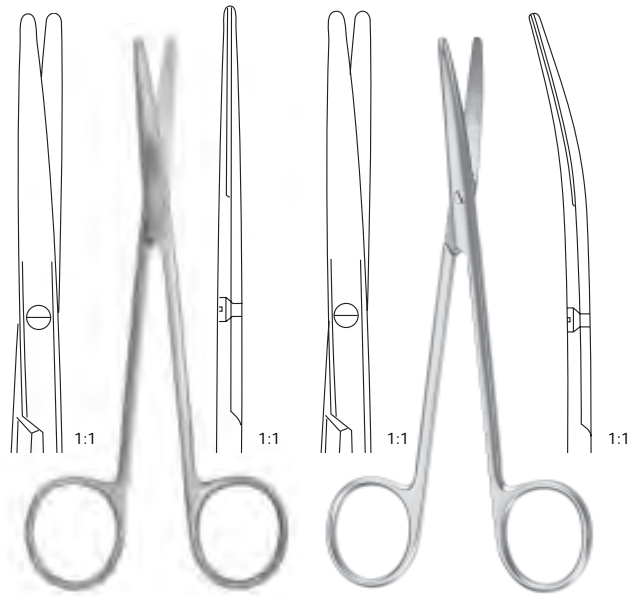

**Metzenbaum**  
Fig. 1  
14.5 cm, 5 3/4"  
gerade, straight  
120-110-145  
120-510-145

**Metzenbaum**  
Fig. 1  
14.5 cm, 5 3/4"  
gebogen, curved  
120-111-145  
120-511-145

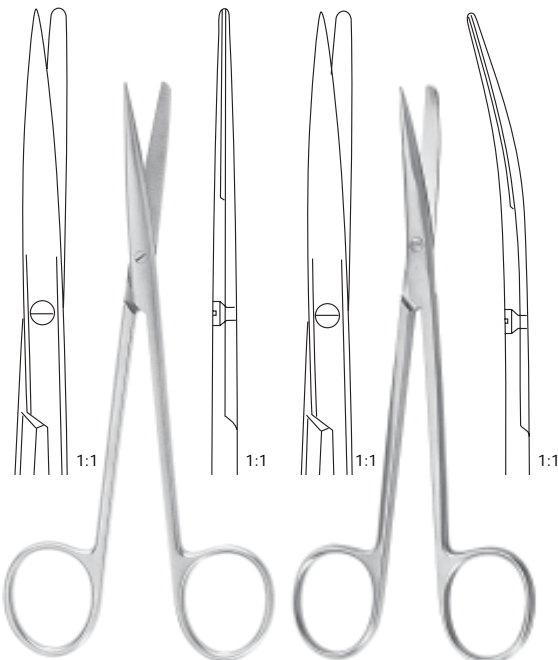

**Metzenbaum**  
Fig. 2  
14.5 cm, 5 3/4"  
gerade, straight  
120-112-145  
120-512-145

**Metzenbaum**  
Fig. 2  
14.5 cm, 5 3/4"  
gebogen, curved  
120-113-145  
120-513-145

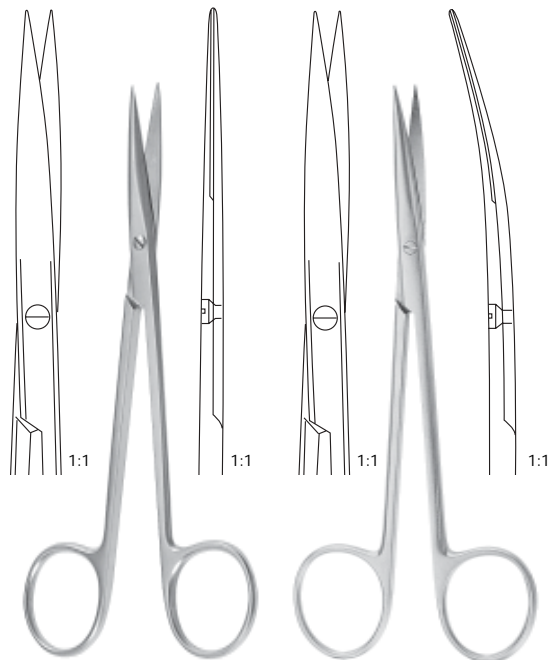

**Metzenbaum**  
Fig. 3  
14.5 cm, 5 3/4"  
gerade, straight  
120-114-145  
120-514-145

**Metzenbaum**  
Fig. 3  
14.5 cm, 5 3/4"  
gebogen, curved  
120-115-145  
120-515-145



Metzenbaum-Nelson

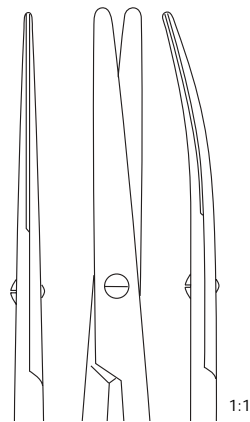

Fig. 1

gerade  
straight

gebogen  
curved

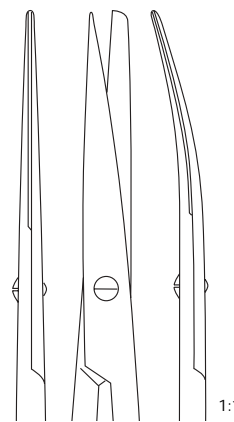

Fig. 2

gerade  
straight

gebogen  
curved

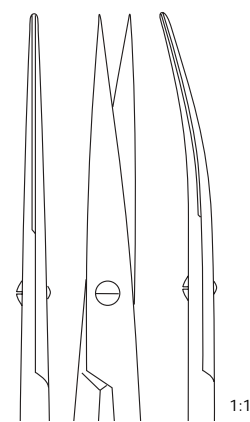

Fig. 3

gerade  
straight

gebogen  
curved

18.0 cm / 7"	120-110-180	120-111-180	120-112-180	120-113-180	120-114-180	120-115-180
18.0 cm / 7"	120-510-180	120-511-180	120-512-180	120-513-180	120-514-180	120-515-180
20.0 cm / 8"	120-110-200	120-111-200	120-112-200	120-113-200	120-114-200	120-115-200
20.0 cm / 8"	120-510-200	120-511-200	120-512-200	120-513-200	120-514-200	120-515-200
23.0 cm / 9"	120-110-230	120-111-230	120-112-230	120-113-230	120-114-230	120-115-230
23.0 cm / 9"	120-510-230	120-511-230	120-512-230	120-513-230	120-514-230	120-515-230
25.0 cm / 10"	120-110-250	120-111-250	120-112-250	120-113-250	120-114-250	120-115-250
25.0 cm / 10"	120-510-250	120-511-250	120-512-250	120-513-250	120-514-250	120-515-250
28.0 cm / 11"	120-110-280	120-111-280	120-112-280	120-113-280	120-114-280	120-115-280
28.0 cm / 11"	120-510-280	120-511-280	120-512-280	120-513-280	120-514-280	120-515-280
30.0 cm / 12"	120-110-300	120-111-300	120-112-300	120-113-300	120-114-300	120-115-300
30.0 cm / 12"	120-510-300	120-511-300	120-512-300	120-513-300	120-514-300	120-515-300

Alle **Metzenbaum / Metzenbaum-Nelson** Präparierscheren mit RZ-Dur Cut können auch mit dem speziellen RZ-Wellenschliff geliefert werden. Der Wellenschliff verhindert das Ausgleiten des zu schneidenden Materials, ohne die Schneidfähigkeit zu reduzieren oder die Schnitthaltigkeit zu beeinträchtigen. Bei der Bestellung ist diese Angabe besonders zu vermerken. Diese Scheren haben einen schwarzen und einen goldenen Ring.

All **Metzenbaum / Metzenbaum-Nelson** Dissecting Scissors with RZ-Dur Cut can be also delivered with the special RZ-corrugated grinding. This corrugated grinding prevents the material to be cut from slipping out without reducing the actual cutting or the durability of the scissors. Please indicate on your order the type / pattern you require. Those scissors have one black and one gold ring.

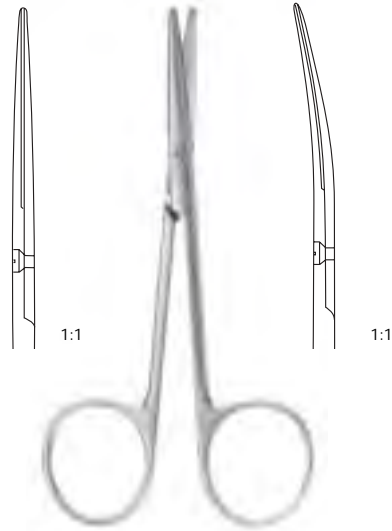

**Lexer-Baby**  
 gerade, straight      gebogen, curved

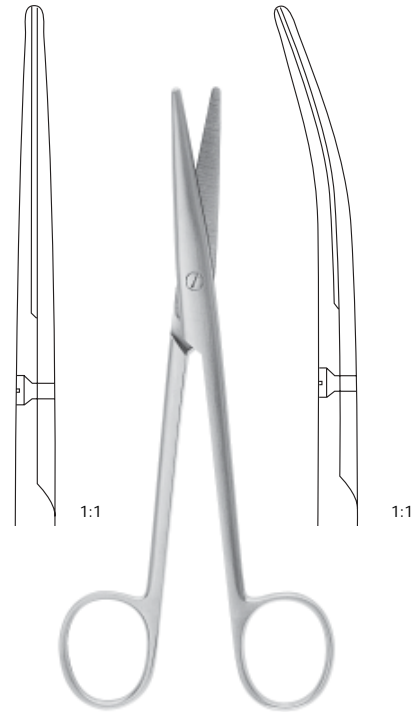

**Lexer**  
 gerade, straight      gebogen, curved

10.0 cm, 4 "	120-136-100	120-137-100		
16.0 cm, 6 1/4"			120-126-160	120-127-160
16.0 cm, 6 1/4"			120-516-160	120-517-160
21.0 cm, 8 1/4"			120-126-210	120-127-210
21.0 cm, 8 1/4"			120-516-210	120-517-210



**Fomon**  
 13.5 cm, 5 3/8"  
 120-131-135

**Thorek**  
 19.0 cm, 7 1/2"  
 120-133-190

**Nerv-Präparierschere**  
 Nerve dissecting scissors

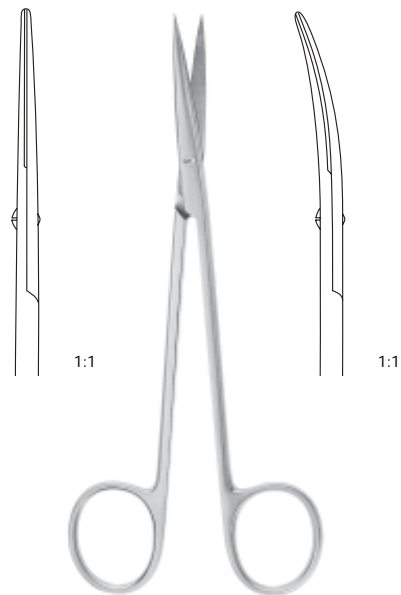

15.0 cm, 6"  
 gerade, straight  
 120-120-150

gebogen, curved  
 120-121-150

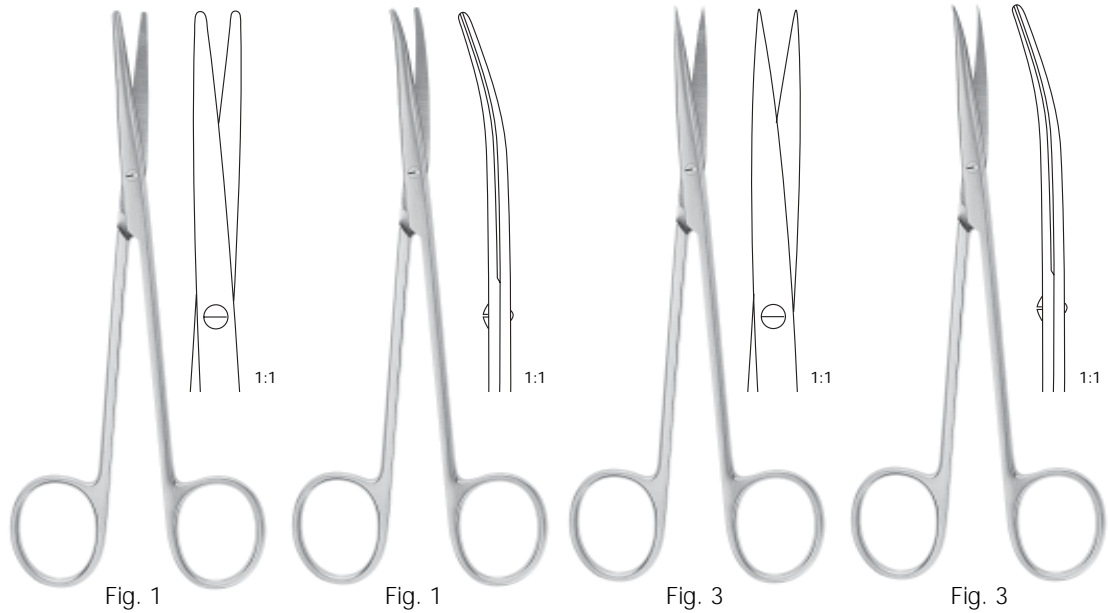

Metzenbaum-Fino

14.5 cm, 5 3/4"	120-152-145	120-153-145	120-154-145	120-155-145
14.5 cm, 5 3/4"	120-520-145	120-521-145	120-522-145	120-523-145

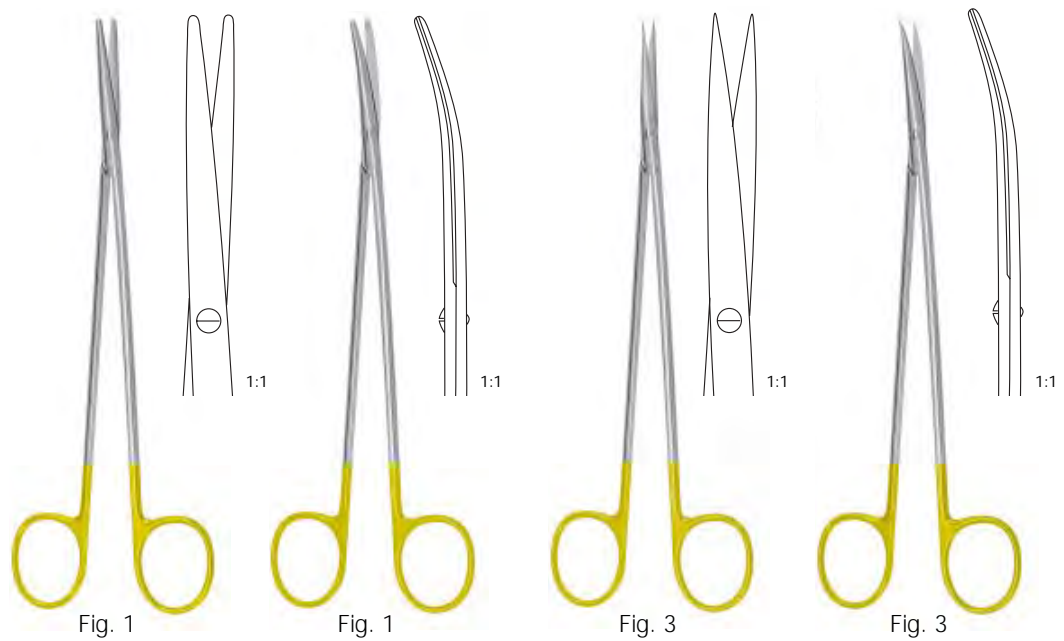

Metzenbaum-Fino

18.0 cm, 7"	120-152-180	120-153-180	120-154-180	120-155-180
18.0 cm, 7"	120-520-180	120-521-180	120-522-180	120-523-180
20.0 cm, 8"	120-152-200	120-153-200	120-154-200	120-155-200
20.0 cm, 8"	120-520-200	120-521-200	120-522-200	120-523-200
23.0 cm, 9"	120-152-230	120-153-230	120-154-230	120-155-230
23.0 cm, 9"	120-520-230	120-521-230	120-522-230	120-523-230
25.0 cm, 10"	120-152-250	120-153-250	120-154-250	120-155-250
25.0 cm, 10"	120-520-250	120-521-250	120-522-250	120-523-250
28.0 cm, 11"	120-152-280	120-153-280	120-154-280	120-155-280
28.0 cm, 11"	120-520-280	120-521-280	120-522-280	120-523-280
30.0 cm, 12"	120-152-300	120-153-300	120-154-300	120-155-300
30.0 cm, 12"	120-520-300	120-521-300	120-522-300	120-523-300



3

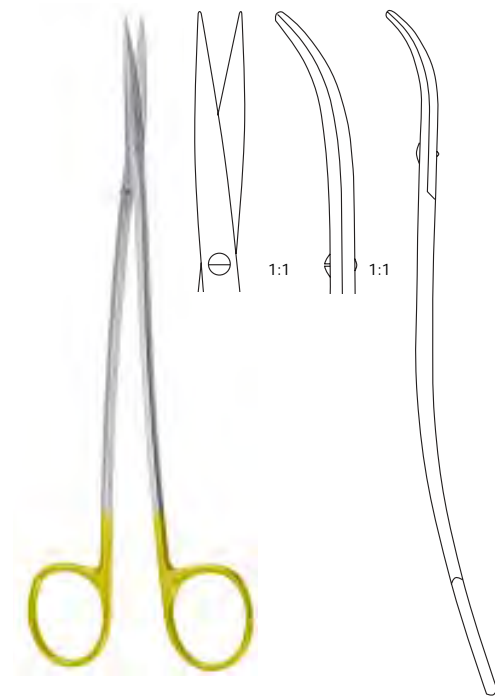
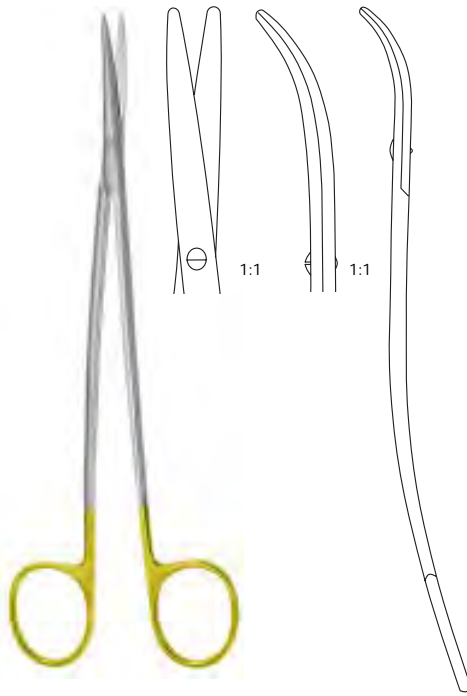

Metzenbaum-Fino  
 S-gebogen, S-curved

Metzenbaum-Fino  
 S-gebogen, S-curved

18.0 cm, 7"	120-157-180	120-159-180
18.0 cm, 7"	120-525-180	120-527-180
20.0 cm, 8"	120-157-200	120-159-200
20.0 cm, 8"	120-525-200	120-527-200
23.0 cm, 9"	120-157-230	120-159-230
23.0 cm, 9"	120-525-230	120-527-230

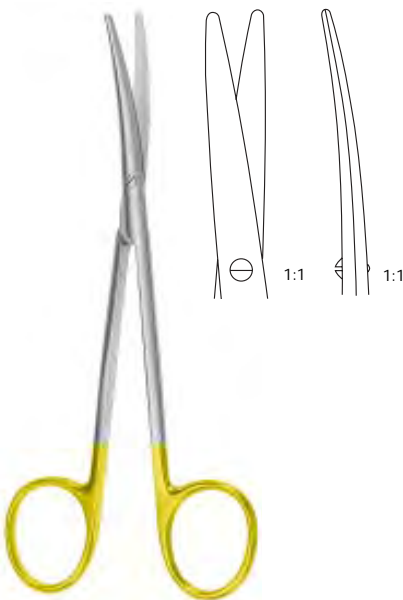

Metzenbaum-Lahey  
 14.0 cm, 5 1/2"  
 gebogen, curved  
 120-530-140

Toennis-Adson  
 17.0 cm, 6 3/4"  
 gebogen, curved  
 120-257-170  
 120-531-170



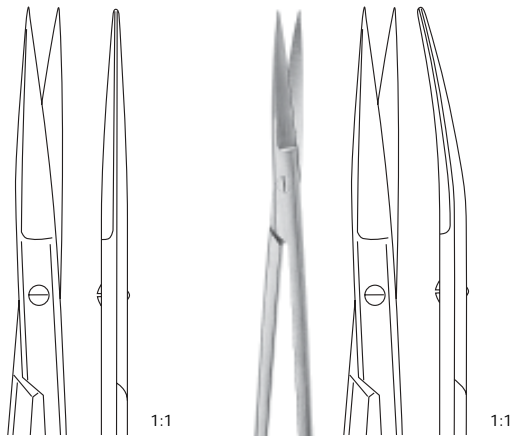

**Sanvenero**  
 14.0 cm, 5 1/2"

gerade, straight  
 120-056-140

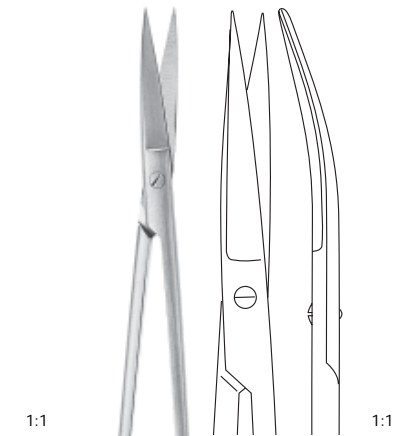
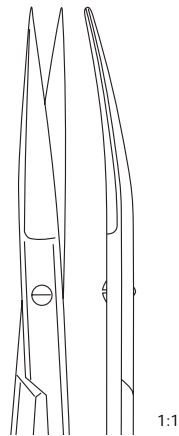

**Joseph**  
 14.0 cm, 5 1/2"

gerade, straight  
 120-058-140

gebogen, curved  
 120-059-140

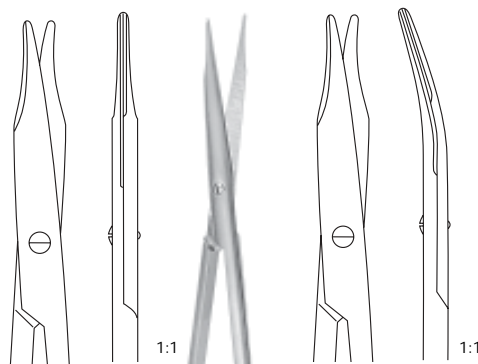

**Reynolds**

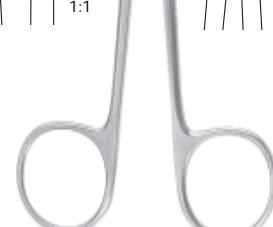
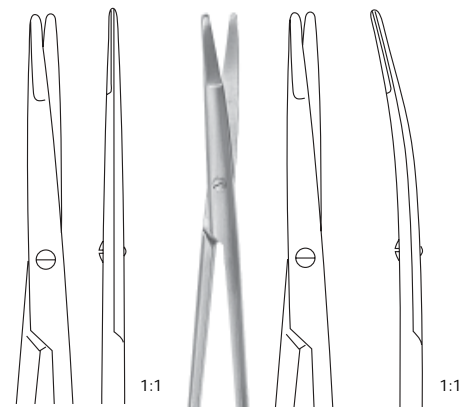

**Kilner (Ragnell)**

12.0 cm, 4 3/4"			120-064-120	120-065-120
15.0 cm, 6"	120-042-150	120-043-150	120-064-150	120-065-150
<b>15.0 cm, 6"</b>	<b>120-542-150</b>	<b>120-543-150</b>		
18.0 cm, 7"	120-042-180	120-043-180	120-064-180	120-065-180
20.0 cm, 8"			120-064-200	120-065-200



3

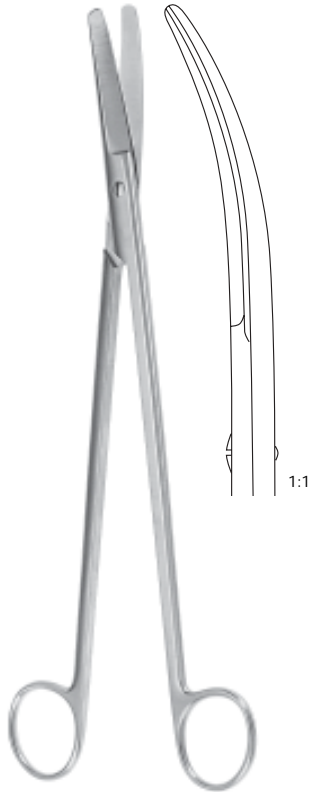

**Crafoord**  
 30.0 cm, 12"  
 120-201-300

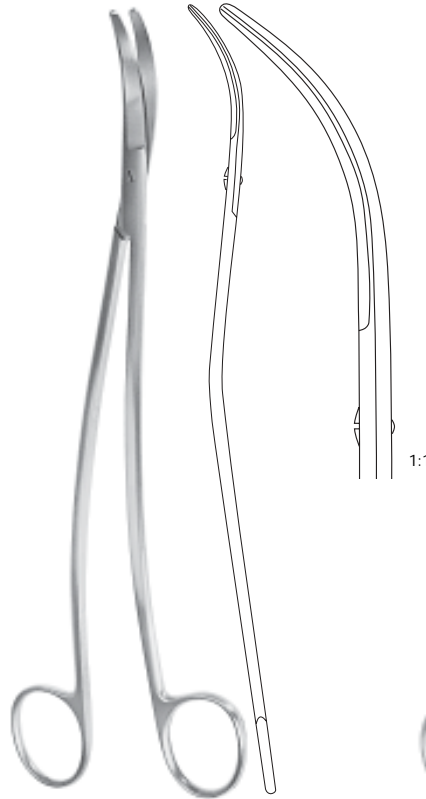

**Satinsky**  
 24.5 cm, 9 5/8"  
 120-203-245

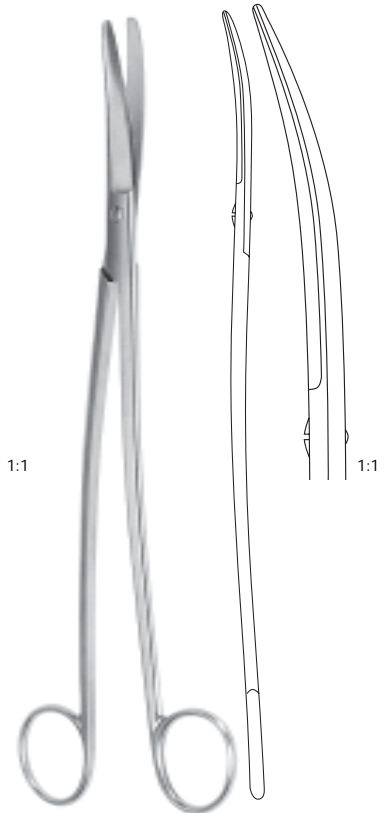

**Klinkenberg-Loth**  
 23.0 cm, 9"  
 120-205-230



**Dietrich-Hegemann**  
 18.0 cm, 7"

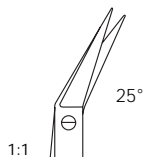

120-175-025  
 120-570-025

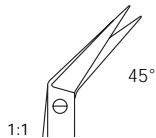

120-175-045  
 120-570-045

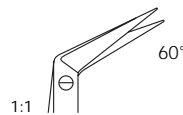

120-175-060  
 120-570-060



120-175-090  
 120-570-090



120-175-125  
 120-570-125

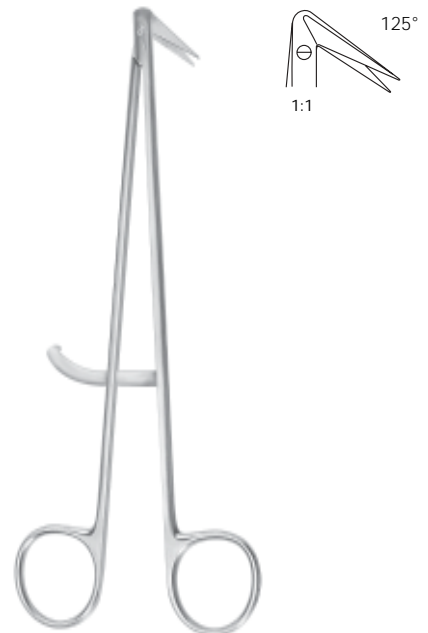

**Diethrich  
 Circumflex**  
 17.5 cm, 6 5/8"  
 120-176-125  
 120-576-125

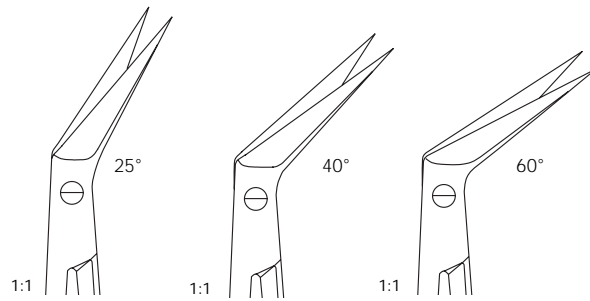
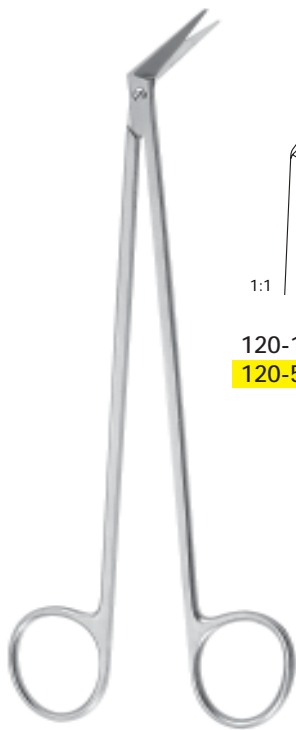

120-181-190  
 120-581-190

120-182-190  
 120-582-190

120-183-190  
 120-583-190

Potts-Smith  
 19.0 cm, 7 1/2"

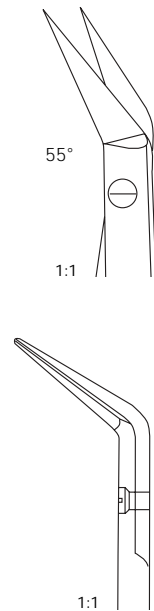

Potts-Smith  
 18.0 cm, 7"  
 120-185-180

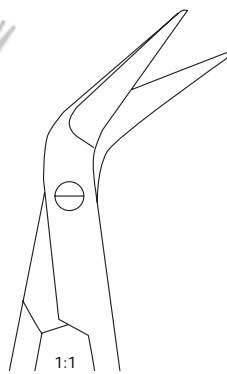
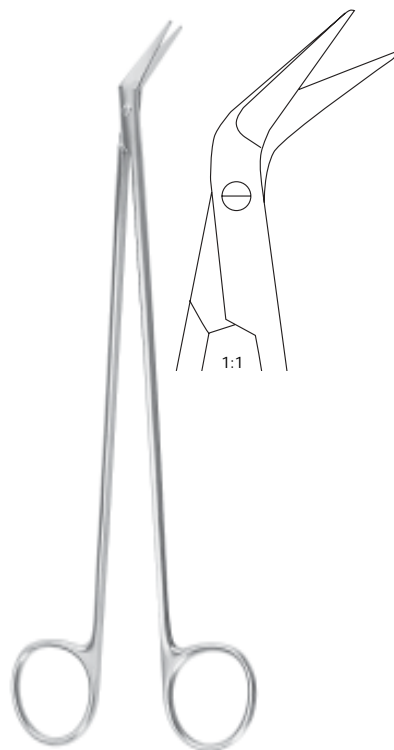

Potts de Martel  
 21.0 cm, 8 1/4"  
 120-179-210  
 24.0 cm, 9 1/2"  
 120-179-240  
 120-579-240

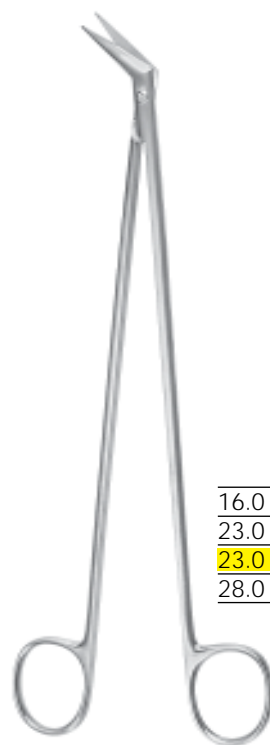

De Bakey

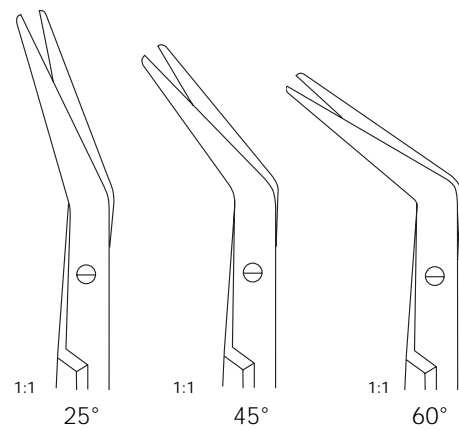

16.0 cm, 6 1/4"	120-192-025	120-192-045	120-192-060
23.0 cm, 9"	120-193-025	120-193-045	120-193-060
23.0 cm, 9"	120-593-025	120-593-045	120-593-060
28.0 cm, 11"	120-194-025	120-194-045	120-194-060



3

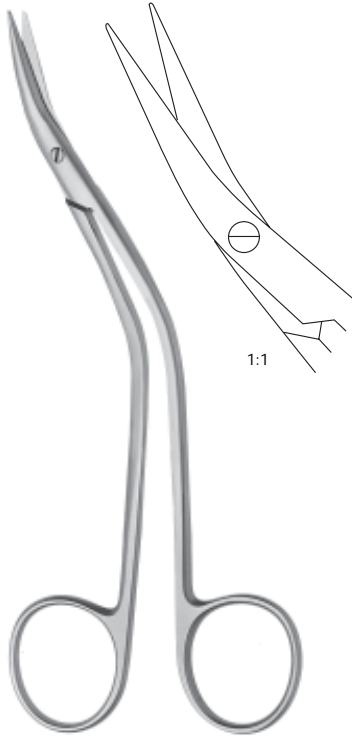

**De Bakey**  
15.5 cm, 6"  
120-195-155

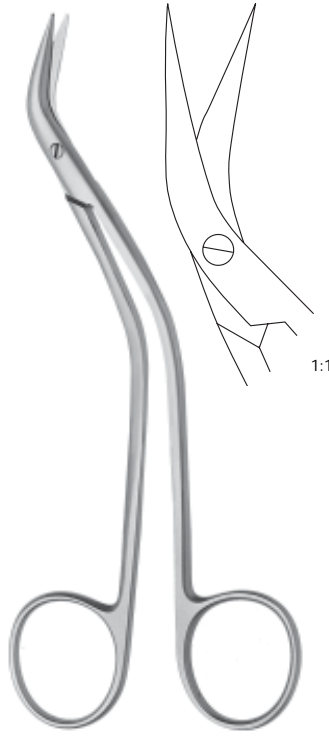

**De Bakey**  
15.5 cm, 6"  
120-197-155

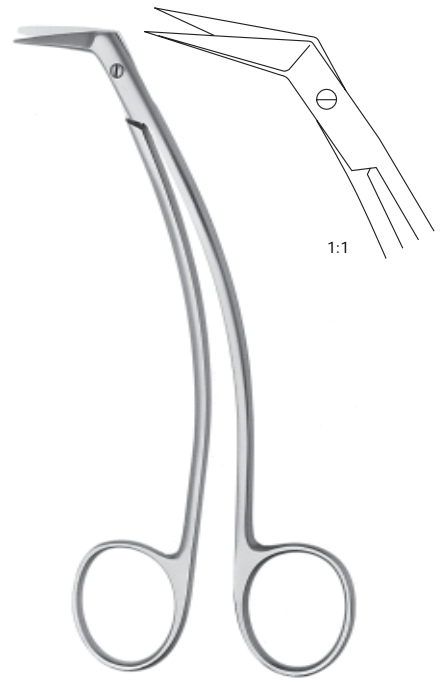

**Favaloro**  
15.5 cm, 6"  
120-199-155

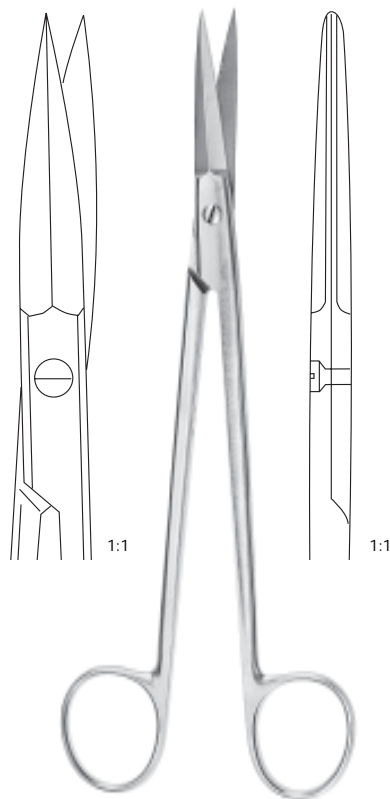

**Mc Indoe**  
19.0 cm, 7 1/2"  
120-190-190



**Coronar-Schere**  
**Coronary-Scissors**  
11.5 cm, 4 1/2"  
120-420-115

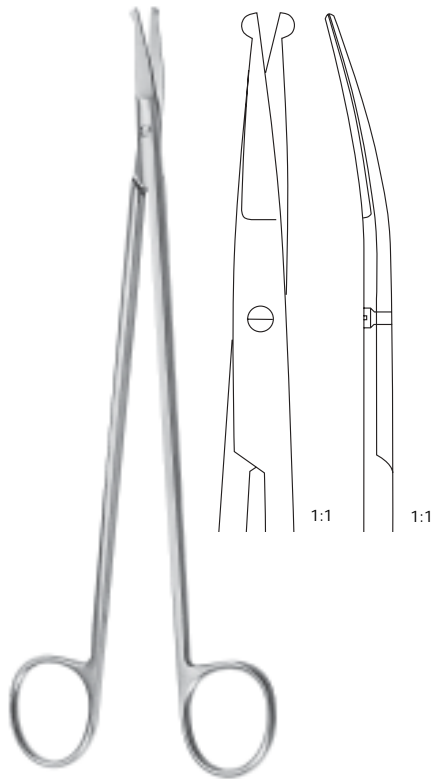

**Strully**  
22.0 cm, 8 5/8"  
120-250-220

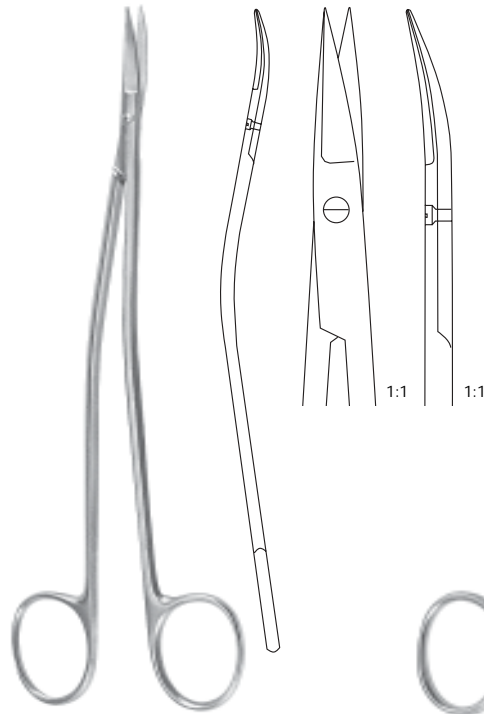

**Dandy**  
17.0 cm, 6 3/4"  
120-253-170

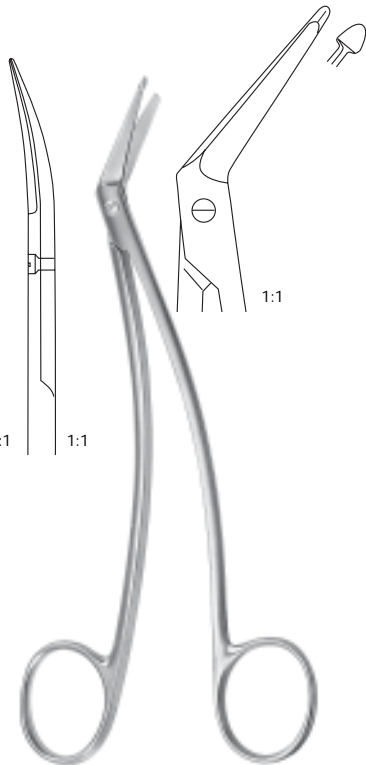

**Schmieden-Taylor**  
17.0 cm, 6 3/4"  
120-430-170

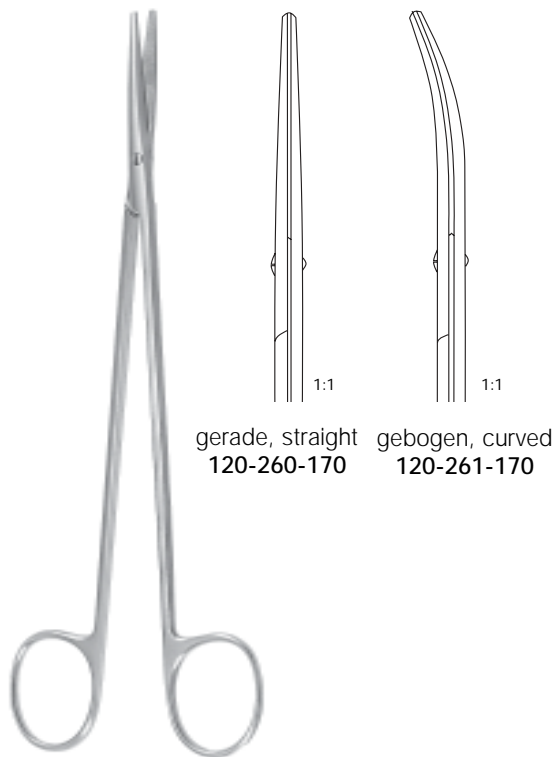

**Lincoln**  
17.0 cm, 6 3/4"

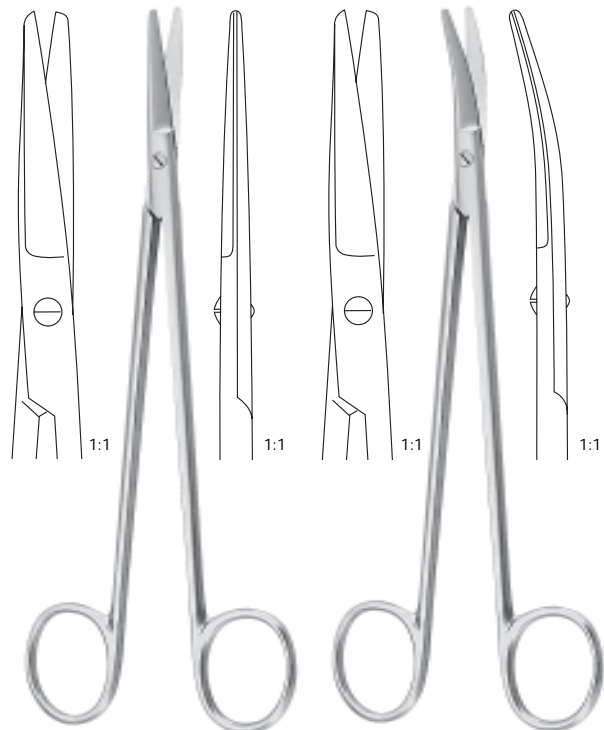

**Toennis**  
18.0 cm, 7"  
gerade, straight  
120-254-180

gebogen, curved  
120-255-180



3



**Halle**  
19.0 cm, 7 1/2"  
120-275-190

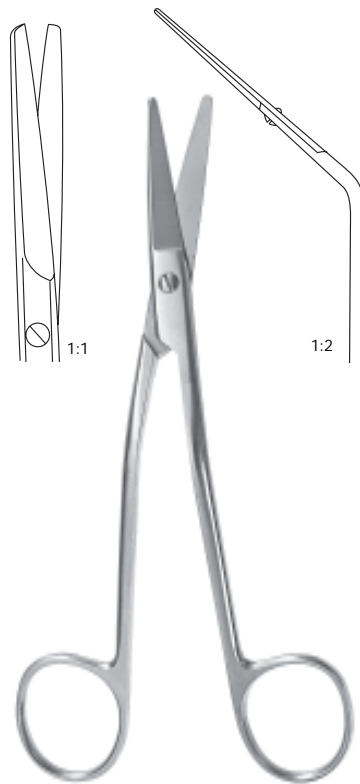

**Fomon**  
15.0 cm, 6"  
120-280-150

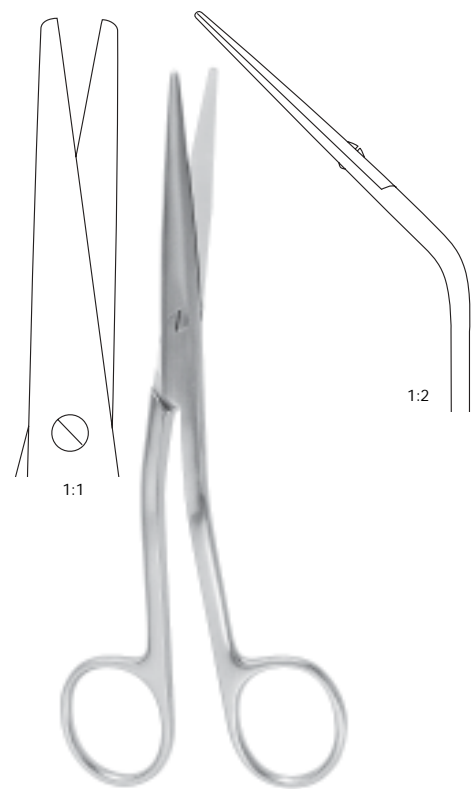

**Cottle**  
16.0 cm, 6 1/4"  
120-281-160



**Heymann**  
18.0 cm, 7"  
120-283-180

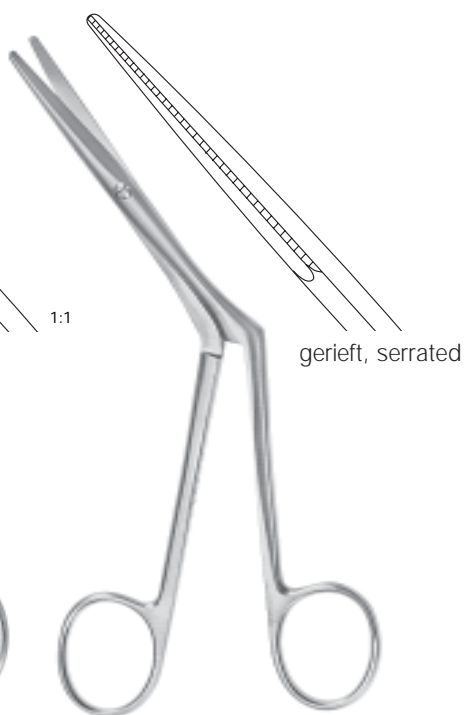

**Kirstein**  
18.0 cm, 7"  
120-285-175



**Caplan**  
22.0 cm, 8 5/8"  
gerade, straight      gebogen, curved  
120-286-220      120-287-220

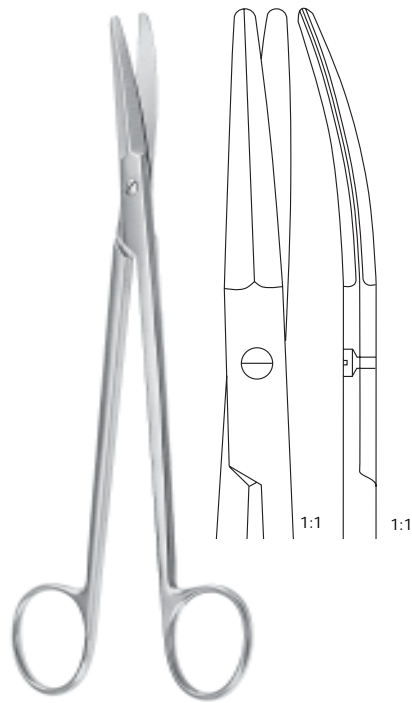

**Boettcher**  
 18.0 cm, 7"  
 120-209-180

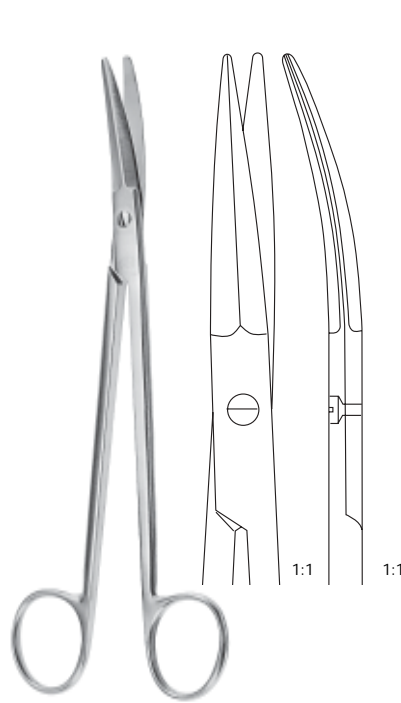

**Prince**  
 17.5 cm, 6 5/8"  
 120-213-175

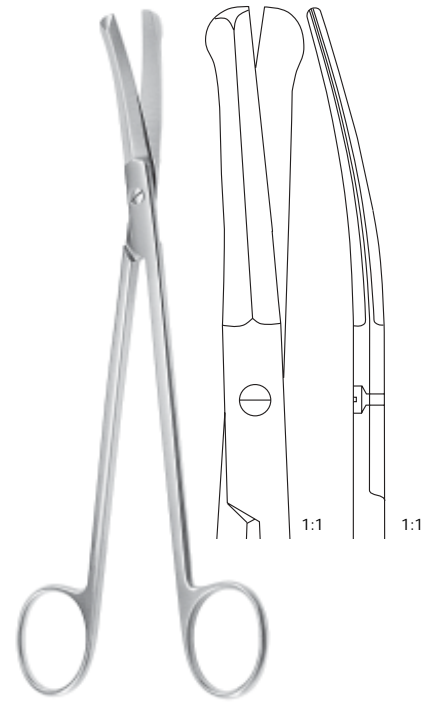

**Good**  
 19.0 cm, 7 1/2"  
 120-217-190



**Martin-Cartilage**  
 20.0 cm, 8"  
 120-206-200



21.0 cm, 8 1/4"  
 120-233-210



21.0 cm, 8 1/4"  
 120-234-210



21.0 cm, 8 1/4"  
 120-235-210



3



**Lloyd-Davies  
(Goligher's)**  
27.0 cm, 10 <sup>5</sup>/<sub>8</sub>"  
120-240-270

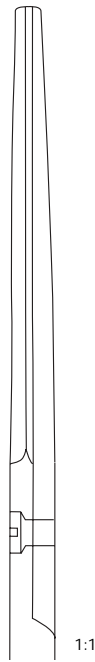

**Stelzner**  
31.0 cm, 12 <sup>1</sup>/<sub>4</sub>"  
gerade, straight  
120-242-310



gebogen, curved  
120-243-310

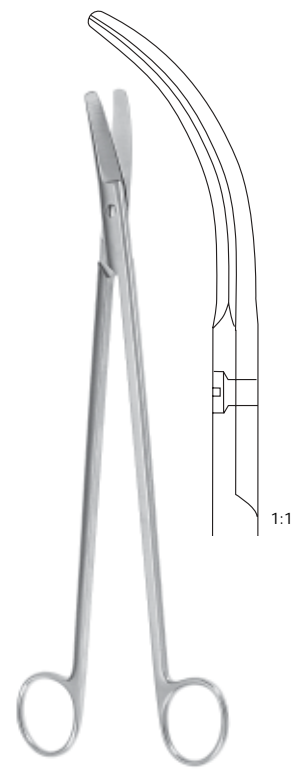

**Rectal**  
gebogen, curved  
32.5 cm, 12 <sup>3</sup>/<sub>4</sub>"  
120-245-325



**Willauer**  
gerade, straight      gebogen, curved

25.0 cm, 9 <sup>3</sup> / <sub>4</sub> "	120-214-250	120-215-250
28.0 cm, 11"	120-214-280	120-215-280

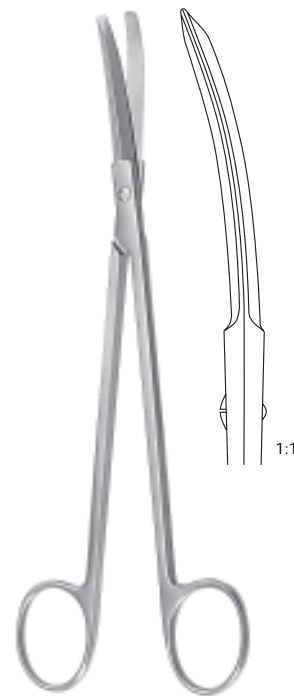

**Potts-Smith**  
19.0 cm, 7 <sup>1</sup>/<sub>2</sub>"  
120-216-190

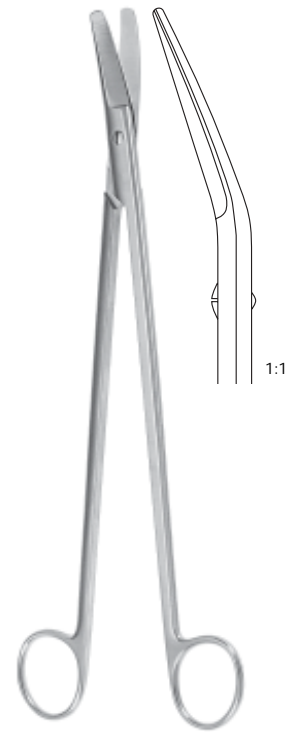

**Finochietto**  
27.0 cm, 10 <sup>5</sup>/<sub>8</sub>"  
120-210-270





**Waldmann**  
18.0 cm, 7"  
120-231-180



**Braun-Stadler**  
14.5 cm, 5 3/4"  
120-225-145  
20.0 cm, 8"  
120-225-200



**RZ-Episiotomy**  
20.0 cm, 8"  
120-232-200



**Mod. USA**  
10.5 cm, 4 1/8"  
120-233-105



**Busch**  
13.5 cm, 5 3/8"  
120-229-135  
16.0 cm, 6 1/4"  
120-229-160



**Schumacher**  
16.0 cm, 6 1/4"  
120-227-160



3



**Wagner**  
 12.0 cm, 4 3/4"



Fig.1  
 gerade, straight  
 120-046-120



Fig.1  
 gebogen, curved  
 120-047-120

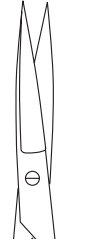

Fig.3  
 gerade, straight  
 120-054-120



Fig.3  
 gebogen, curved  
 120-055-120



**Strabismus**  
 11.5 cm, 4 1/2"

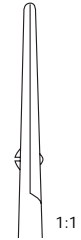

gerade, straight  
 120-094-115

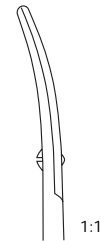

gebogen, curved  
 120-095-115



Iris

9.0 cm, 3 1/2"	120-070-090	120-071-090		
10.5 cm, 4 1/8"	120-070-105	120-071-105	120-080-105	120-081-105
11.5 cm, 4 1/2"	120-070-115	120-071-115	120-080-115	120-081-115
11.5 cm, 4 1/2"	120-554-115	120-555-115		



3



11.5 cm, 4 1/2"  
120-083-115



11.5 cm, 4 1/2"  
120-085-115



12.0 cm, 4 3/4"  
120-086-120



12.0 cm, 4 3/4"  
120-087-120

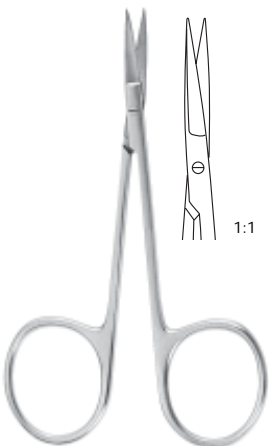

**Mod. Bonn**  
sehr fein, extra delicate  
8.0 cm, 3 1/4"  
gerade, straight  
120-072-080

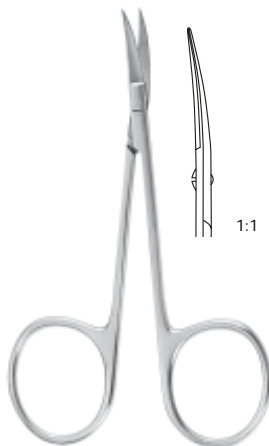

gebogen, curved  
120-073-080

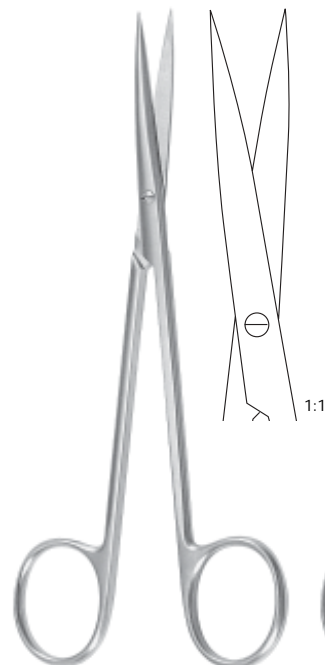

**Brophy (Sullivan)**  
14.0 cm, 5 1/2"  
gerade, straight  
120-054-140

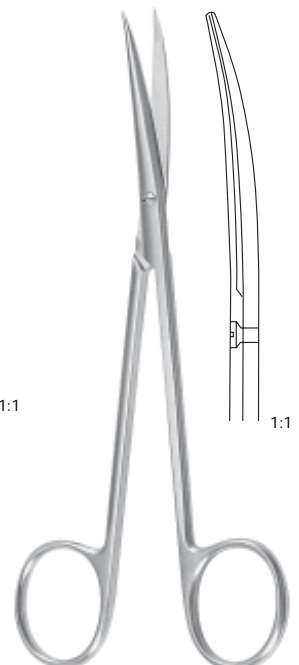

gebogen, curved  
120-055-140



3

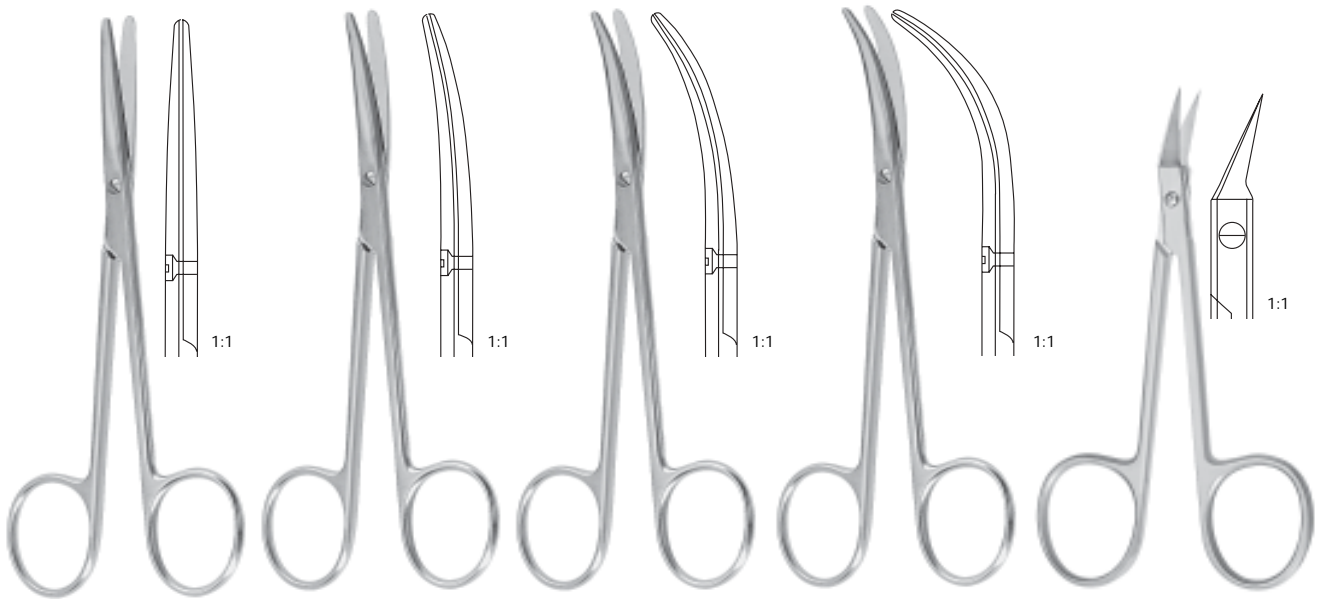

**Landolt**  
 12.5cm, 5"

gerade  
 straight  
 120-122-125

leicht gebogen  
 slightly curved  
 120-123-125

gebogen  
 curved  
 120-124-125

stark gebogen  
 acutely curved  
 120-125-125

**O'Brien**  
 9.5 cm, 3 3/4"  
 120-084-095

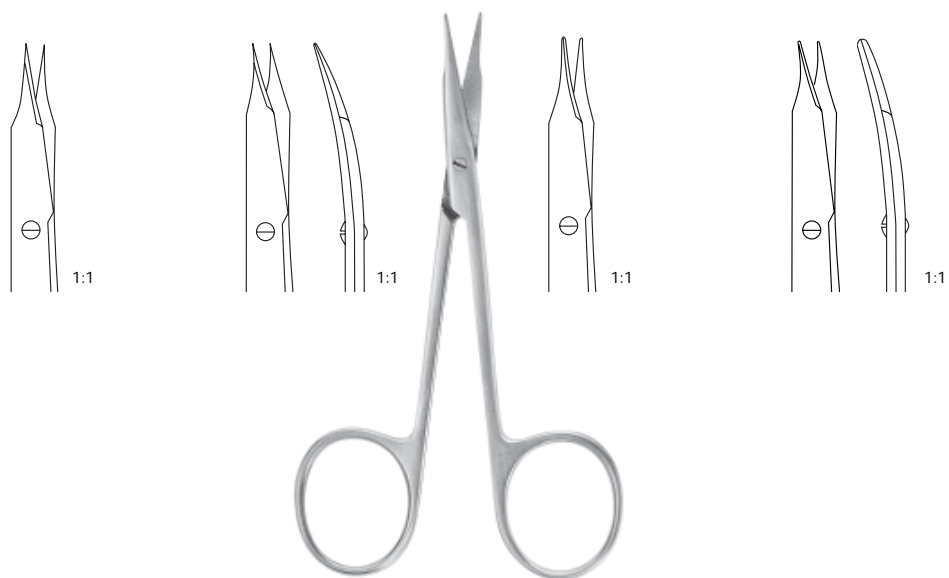

**Stevens**

	spitz, pointed		stumpf, blunt	
	gerade, straight	gebogen, curved	gerade, straight	gebogen, curved
10.5 cm, 4 1/8"	120-090-105	120-091-105	120-092-105	120-093-105
11.5 cm, 4 1/2"	120-090-115	120-091-115	120-092-115	120-093-115



**Spencer**  

9.0 cm, 3 1/2"	120-220-090
10.5 cm, 4 1/8"	120-220-105
13.0 cm, 5"	120-220-130



**Littauer**  

11.5 cm, 4 1/4"	120-224-115
14.0 cm, 5 1/2"	120-224-140

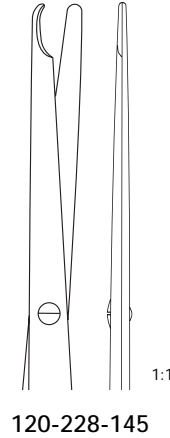

120-228-145

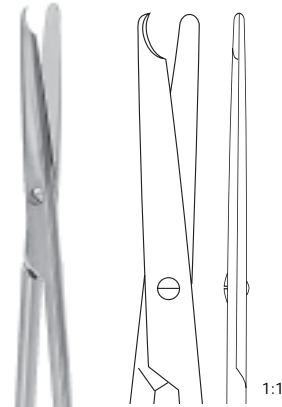

120-228-180

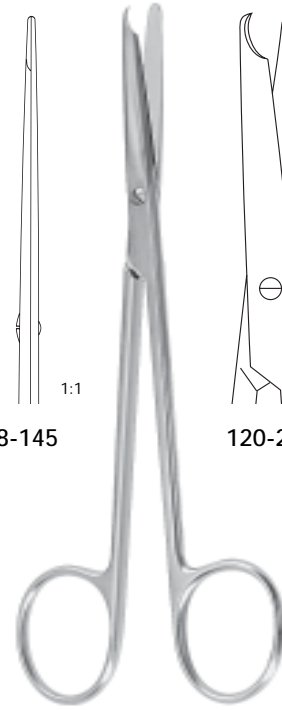

**Buck**  

14.5 cm, 5 3/4"	120-228-145
18.0 cm, 7"	120-228-180



**Shortbent**  
 9.0 cm, 3 1/2"  
 120-223-090



**Northbent**  
 13.0 cm, 5"  
 120-222-130



**Eiselsberg**  
 12.0 cm, 4 3/4"  
 120-230-120

**Heath**  
 16.0 cm, 6 1/4"  
 120-226-160



Verband und Gips

Draht-, Kleider- und Verbandscheren  
RZ-Dur Cut Scheren

Dressing

Wire, Utility and Bandage Scissors  
RZ-Dur Cut Scissors

3

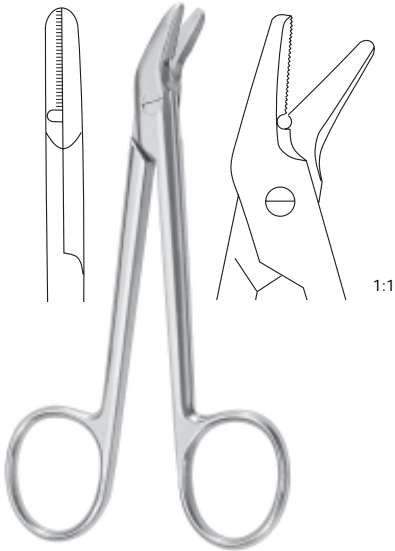

**Universal**  
gezahnt, saw edge  
12.0 cm, 4 3/4"  
120-265-120  
**120-565-120**



143°C autoklavierbar,  
293°F autoclavable  
  
andere Farben  
auf Anfrage  
other colours on  
request  
  
**Universal**  
blau, blue  
18.0 cm, 7"  
190-209-180



16.0 cm, 6 1/4"	120-270-160
18.0 cm, 7"	120-270-180
20.0 cm, 8"	120-270-200
23.0 cm, 9"	120-270-230



9.0 cm, 3 1/2"	190-165-090
11.0 cm, 4 3/8"	190-165-110
14.0 cm, 5 1/2"	190-165-140
18.0 cm, 7"	190-165-180
<b>18.0 cm, 7"</b>	<b>190-291-180</b>
20.0 cm, 8"	190-165-200



18.5 cm, 7 1/4"	190-170-185
21.0 cm, 8 1/4"	190-170-210

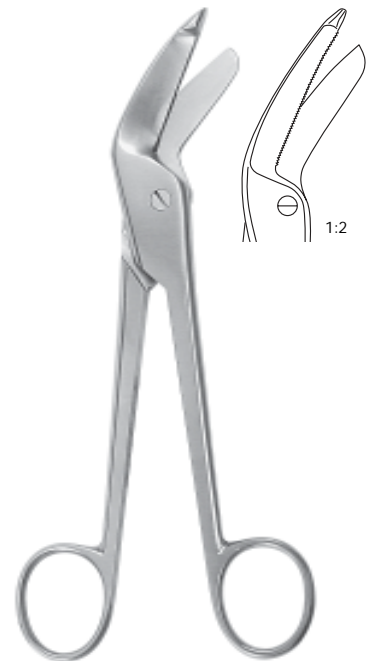

16.0 cm, 6 1/4"	190-177-160
19.0 cm, 7 1/2"	190-177-190

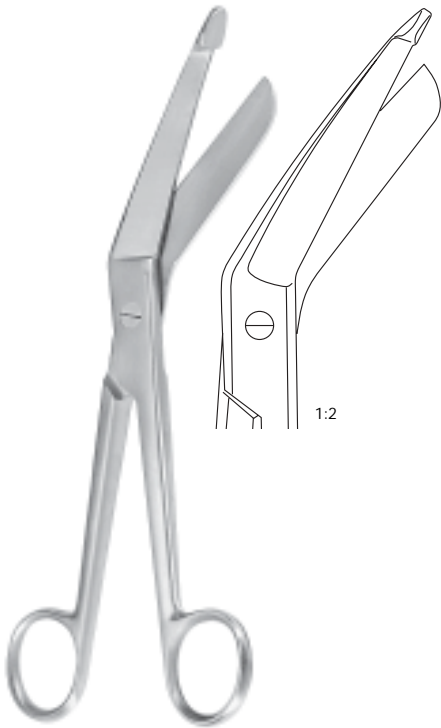

**Bergmann**  
23.0 cm, 9"  
190-195-230

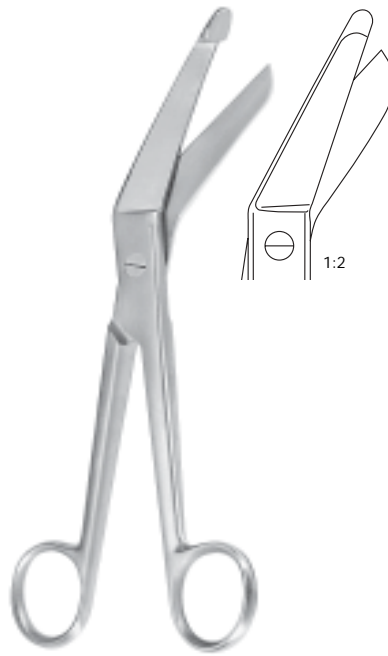

**Esmarch**  
20.0 cm, 8"  
190-205-200  
22.0 cm, 8 5/8"  
190-205-220



**Knowles**  
14.0 cm, 5 1/2"  
190-160-140



**Lorenz**  
23.0 cm, 9"  
190-155-230

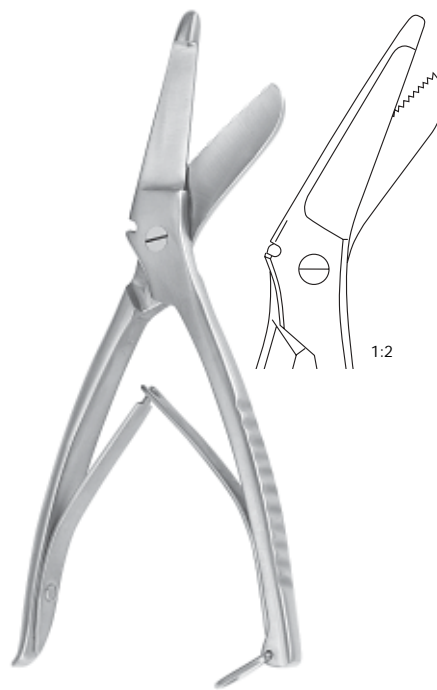

**RZ-Multi**  
gezahnt, saw edge  
20.0 cm, 8"  
190-211-200

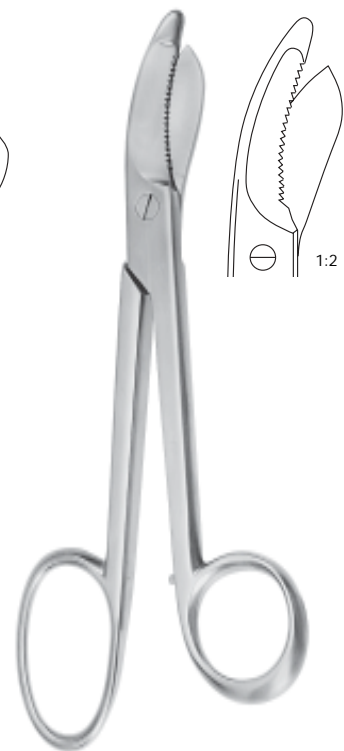

**Bruns**  
24.0 cm, 9 1/2"  
gezahnt, saw edge  
190-223-240

**Bruns**  
24.0 cm, 9 1/2"  
glatt, smooth  
190-224-240  
**190-297-240**



3

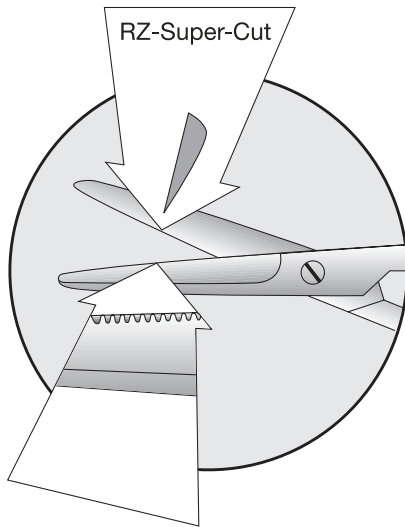

Das RZ-Super-Cut Blatt besitzt eine einzigartige rasierklingscharfe Schneidekante, zum mühelosen Schneiden des Gewebes.

Das untere Blatt besitzt eine ganz feine Riefung, die das Abgleiten des Gewebes verhindert.

Zur leichten Identifizierung hat die RZ-Super Cut Schere schwarze Ringe.

The RZ-Super-Cut blade has a uniquely designed razor sharp edge to cut effortlessly through tissue.

The lower blade has very fine serrations to prevent tissue slippage.

For easy identification RZ-Super-Cut scissors have two black rings.

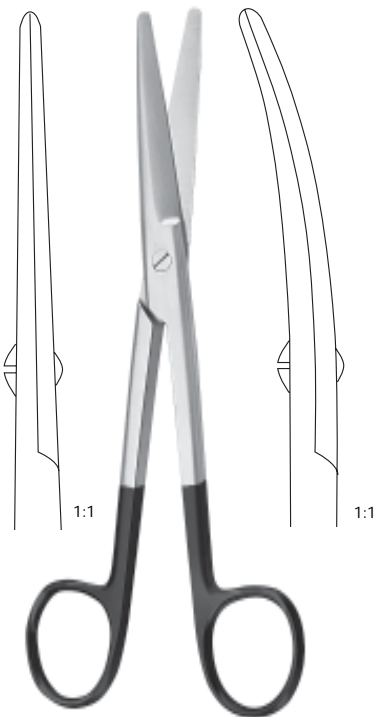

**Mayo**  
17.0 cm, 6 3/4"  
gerade, straight  
121-030-170  
gebogen, curved  
121-031-170

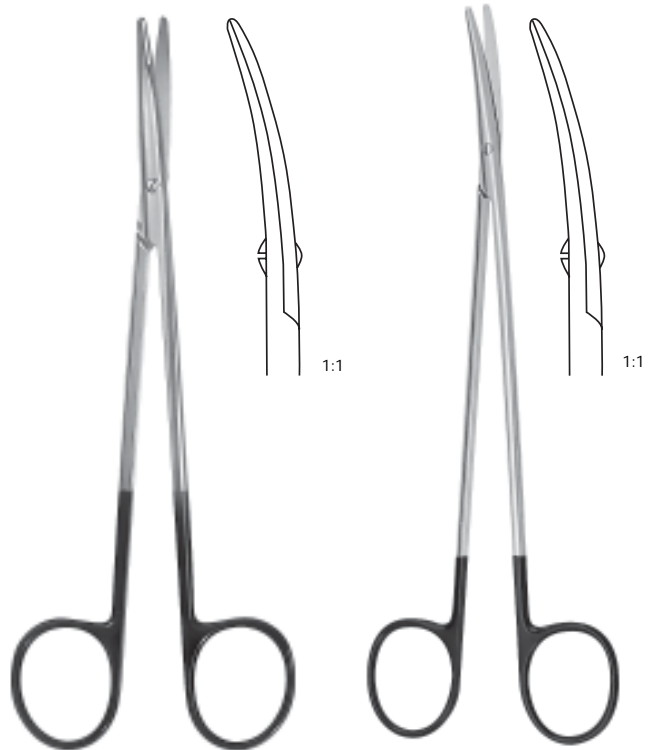

	<b>Metzenbaum</b> gebogen, curved	<b>Metzenbaum-Fino</b> gebogen, curved
14.5 cm, 5 3/4"	121-111-145	121-153-145
18.0 cm, 7"	121-111-180	121-153-180
20.0cm, 8"	121-111-200	121-153-200
23.0 cm, 9"	121-111-230	121-153-230



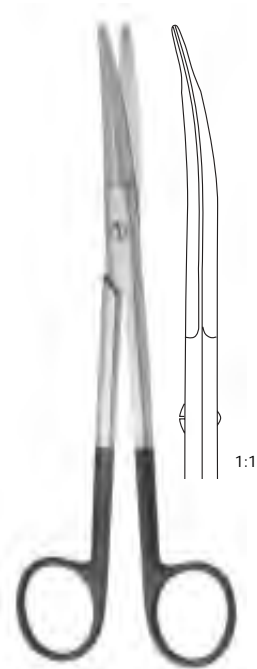

**Kaye Face Lift**  
gebogen, curved  
15.0 cm, 6"  
121-311-150  
19.0 cm, 7 1/2"  
121-311-190



**Jabaley**  
gebogen, curved  
große Ringe, large rings  
13.0 cm, 5"  
121-089-130



**Endarterectomy**  
gebogen, curved  
18.0 cm, 7"  
121-320-180



**Toennis-Adson**  
gebogen, curved  
17.0 cm, 6 3/4"  
121-319-170

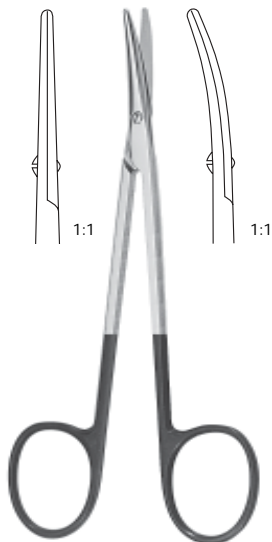

**Strabismus**  
11.5 cm, 4 1/2"  
gerade, straight  
121-094-115  
gebogen, curved  
121-095-115



**Strabismus**  
12.0 cm, 4 3/4"  
gerade, straight  
121-100-120  
gebogen, curved  
121-101-120



**Jamison**  
gebogen, curved  
15.0 cm, 6"  
121-315-150  
18.0 cm, 7"  
121-315-180



**Reynolds**  
gebogen, curved  
12.5 cm, 5"  
121-318-125



3



**Iris**  
11.0 cm, 4 3/8"  
gerade, straight  
121-070-110  
gebogen, curved  
121-071-110



**Metzenbaum-Baby**  
gebogen, curved  
11.0 cm, 4 3/8"  
121-317-110  
14.5 cm, 5 3/4"  
121-317-145



**Stevens Tenotomy**  
11.0 cm, 4 3/8"  
gerade, straight  
121-196-110  
gebogen, curved  
121-197-110



**Par Type**  
11.0 cm, 4 3/8"  
gerade, straight  
121-330-110  
gebogen, curved  
121-331-110



**Potts**  
19.0 cm, 7 1/2"

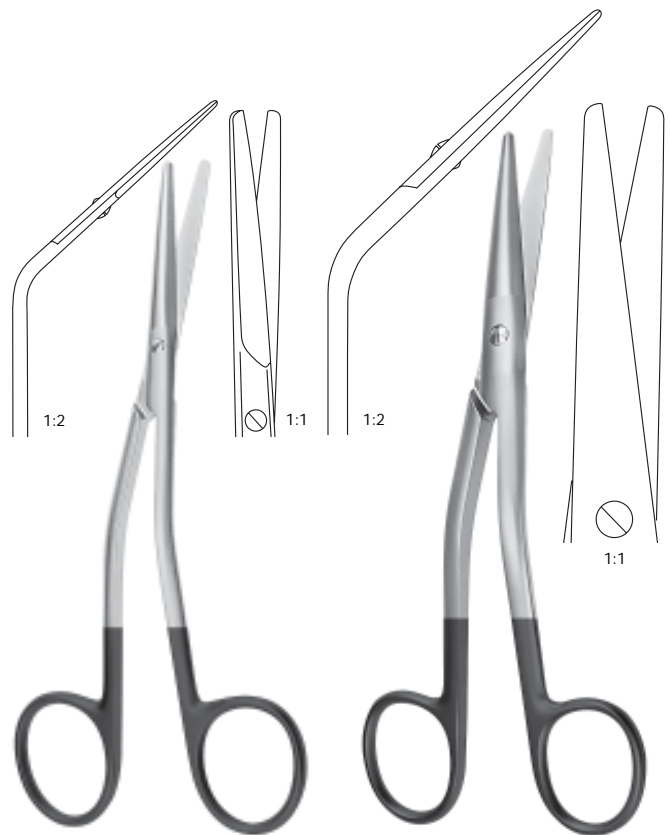
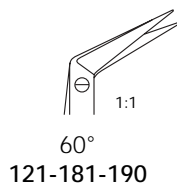
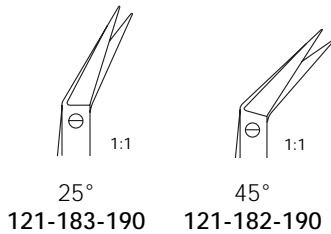

**Fomon**  
14.5 cm, 5 3/4"  
121-280-145

**Cottle**  
16.5 cm, 6 1/2"  
121-290-165



Westcott

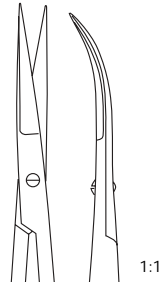

11.0 cm, 4 3/8"  
spitz, sharp  
400-102-110

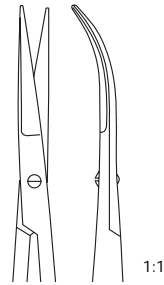

11.0 cm, 4 3/8"  
stumpf, blunt  
400-103-110



Gomel

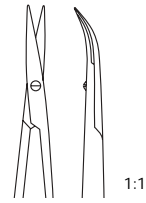

gerieft, serrated  
gebogen, curved  
14.0 cm, 5 1/2"  
120-177-140

16.0 cm, 6 1/4"  
120-177-160

Mikro-Präparierscheren, Micro Dissecting Scissors



Hepp/Scheidel

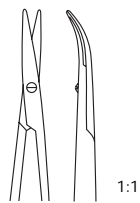

gebogen, curved  
14.0 cm, 5 1/2"  
120-179-140

16.0 cm, 6 1/4"  
120-179-160



18.5 cm, 7 1/4"

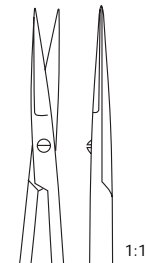

gerade, straight  
120-150-185

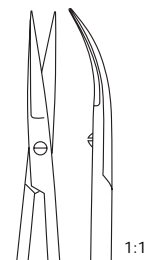

gebogen, curved  
120-151-185

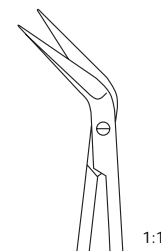

abgewinkelt, angled  
120-153-185



3

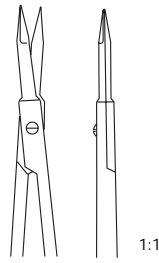

gerade  
straight

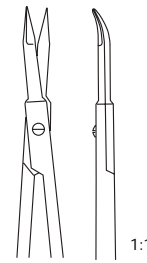

gebogen  
curved

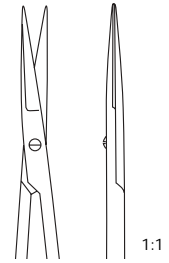

gerade  
straight

18.5 cm, 7 1/4"	120-168-185	120-169-185	120-170-185
22.5 cm, 8 3/4"	120-168-225	120-169-225	120-170-225

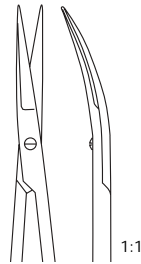

aufgebogen,  
curved upwards

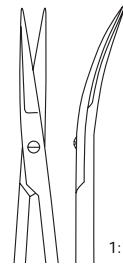

abgebogen,  
curved downwards

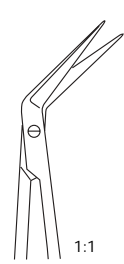

abgewinkelt  
angled

18.5 cm, 7 1/4"	120-171-185	120-172-185	120-173-185
22.5 cm, 8 3/4"	120-171-225	120-172-225	120-173-225



18.0 cm, 7"



25°  
120-182-025

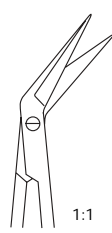

45°  
120-182-045

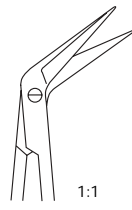

60°  
120-182-060

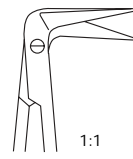

90°  
120-182-090

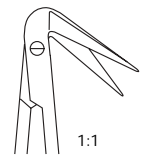

125°  
120-182-125



25°  
120-183-025

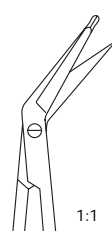

45°  
120-183-045

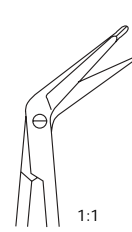

60°  
120-183-060

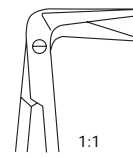

90°  
120-183-090

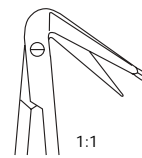

125°  
120-183-125

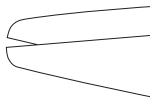

**Dissektionsscheren** - gebogene, abgerundete Spitzen zur leichten Dissektion  
**Dissecting Scissors** - curved blades, rounded tips for fine dissection



15.0 cm 6"



15 mm Schneide, gebogen  
15 mm blades, curved  
**251-551-150**

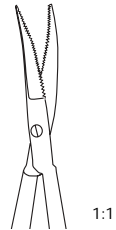

15 mm Schneide, gebogen,  
mit feinen Zähnen  
15 mm blades, curved,  
with micro serrations  
**251-553-150**

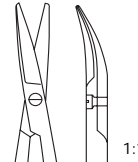

9 mm Schneide  
9 mm blades



15.0 cm, 6"  
8 mm ø Rundgriff,  
8 mm ø round handle  
**120-180-150**

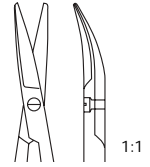

10 mm Schneide  
10 mm blades



18.0 cm, 7"  
8 mm ø Rundgriff,  
8 mm ø round handle  
**120-180-180**



**Adventitiascheren** - gerade, zugespitzte Klingen für feinste Präparationen  
**Adventitia Scissors** - straight blades, pointed at the tip for fine trimming



15.0 cm, 6"

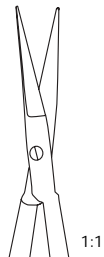

15 mm Schneide, gerade  
15 mm blades, straight  
**251-550-150**

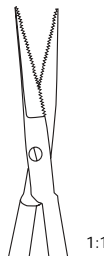

15 mm Schneide, gerade  
mit feinen Zähnen  
15 mm blades, straight  
with micro serrations  
**251-552-150**

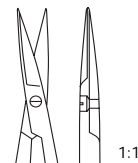

9 mm Schneide  
9 mm blades



15.0 cm, 6"  
8 mm ø Rundgriff,  
8 mm ø round handle  
**120-178-150**

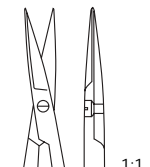

9 mm Schneide  
9 mm blades



18.0 cm, 7"  
8 mm ø Rundgriff,  
8 mm ø round handle  
**120-178-180**



Standard schmal slender schmal slender fein delicate fein delicate fein delicate  
mit Stift with pin

10.5 cm, 4 1/8"	130-010-105	130-013-105	130-012-105	130-014-105	130-015-105	130-018-105
11.5 cm, 4 1/2"	130-010-115	130-013-115	130-012-115	130-014-115	130-015-115	130-018-115
13.0 cm, 5"	130-010-130	130-013-130	130-012-130	130-014-130	130-015-130	130-018-130
14.5 cm, 5 3/4"	130-010-145	130-013-145	130-012-145	130-014-145	130-015-145	130-018-145
15.0 cm, 6"	130-010-150					
16.0 cm, 6 1/4"	130-010-160	130-013-160	130-012-160	130-014-160	130-015-160	130-018-160
18.0 cm, 7"	130-010-180	130-013-180	130-012-180	130-014-180	130-015-180	130-018-180
20.0 cm, 8"	130-010-200	130-013-200	130-012-200	130-014-200	130-015-200	130-018-200
25.0 cm, 10"	130-010-250	130-013-250	130-012-250	130-014-250	130-015-250	130-018-250
30.0 cm, 12"	130-010-300	130-013-300	130-012-300	130-014-300	130-015-300	130-018-300

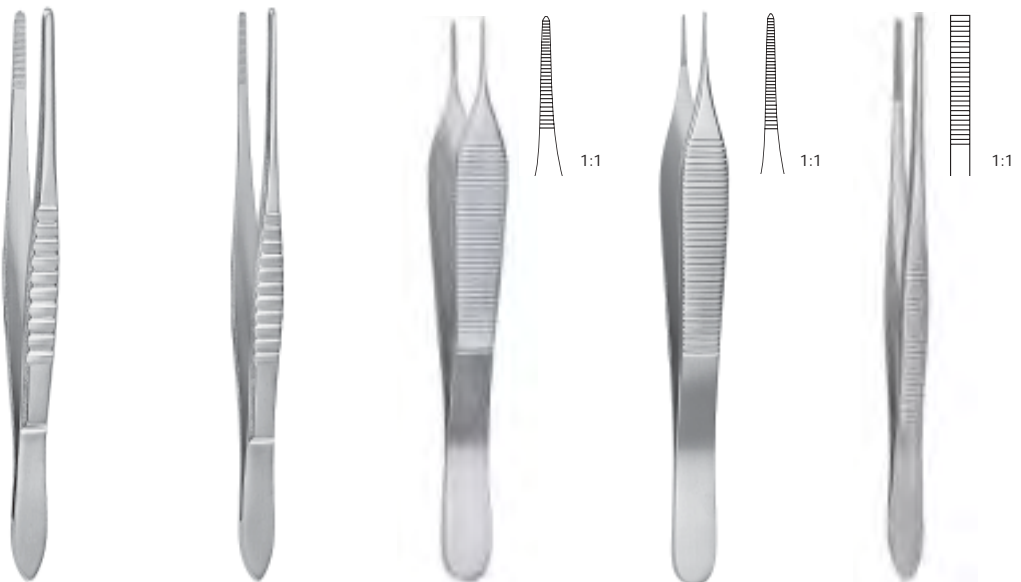

Modell USA Modell USA schmal, slender Adson Micro-Adson Stille

12.0 cm, 4 3/4"	130-046-120	130-048-120	130-026-120	130-548-120	
13.0 cm, 5"	130-046-130	130-048-130			
14.5 cm, 5 3/4"	130-046-145	130-048-145			
15.0 cm, 6"	130-046-150	130-048-150	130-026-150	130-548-150	130-022-150
18.0 cm, 7"	130-046-180	130-048-180			
20.0 cm, 8"	130-046-200	130-048-200			
25.5 cm, 10"	130-046-250	130-048-250			
30.0 cm, 12"	130-046-300				



McIndoe



engl. Modell  
English pattern



Semken



Taylor



Taylor



Taylor  
mit Dissektorende  
with dissector end

12.5 cm, 5"			130-144-125		
13.0 cm, 5"		130-040-130			
14.5 cm, 5 3/4"		130-040-145			
15.0 cm, 6"	130-028-150	130-040-150	130-144-150		
17.5 cm, 6 5/8"				130-030-175	130-133-175
18.5 cm, 7 1/4"					130-035-185



Gerald



Gerald



Cushing



Cushing



Potts-Smith



Potts-Smith

17.5 cm, 6 5/8"			130-036-175	130-037-175		
18.0 cm, 7"	130-034-180	130-035-180			130-038-180	130-037-180
21.0 cm, 8 1/4"					130-038-210	130-037-210
25.0 cm, 10"					130-038-250	130-037-250

4



4



**Waugh**  
15.0 cm, 6"  
130-162-150  
20.0 cm, 8"  
130-162-200



**Brophy**  
20.0 cm, 8"  
130-042-200



**Brophy**  
20.0 cm, 8"  
130-043-200



**Ramsey**  
18.0 cm, 7"  
130-039-180



**Bonney**  
18.0 cm, 7"  
130-043-180



**Singley-Tuttle**  
23.0 cm, 9"  
130-560-230

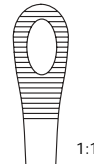

**Dennis Brown**  
20.0 cm, 8"  
130-053-190





Standard				
10.5 cm, 4 1/4"	130-110-105			
11.5 cm, 4 1/2"	130-110-115	130-112-115		
13.0 cm, 5"	130-110-130	130-112-130	130-114-130	130-116-130
14.5 cm, 5 3/4"	130-110-145	130-112-145	130-114-145	130-116-145
15.0 cm, 6"	130-110-150			
16.0 cm, 6 1/4"	130-110-160	130-112-160	130-114-160	130-116-160
18.0 cm, 7"	130-110-180	130-112-180	130-114-180	130-116-180
20.0 cm, 8"	130-110-200	130-112-200	130-114-200	130-116-200
25.0 cm, 10"	130-110-250	130-112-250		
30.0 cm, 12"	130-110-300	130-112-300		

4

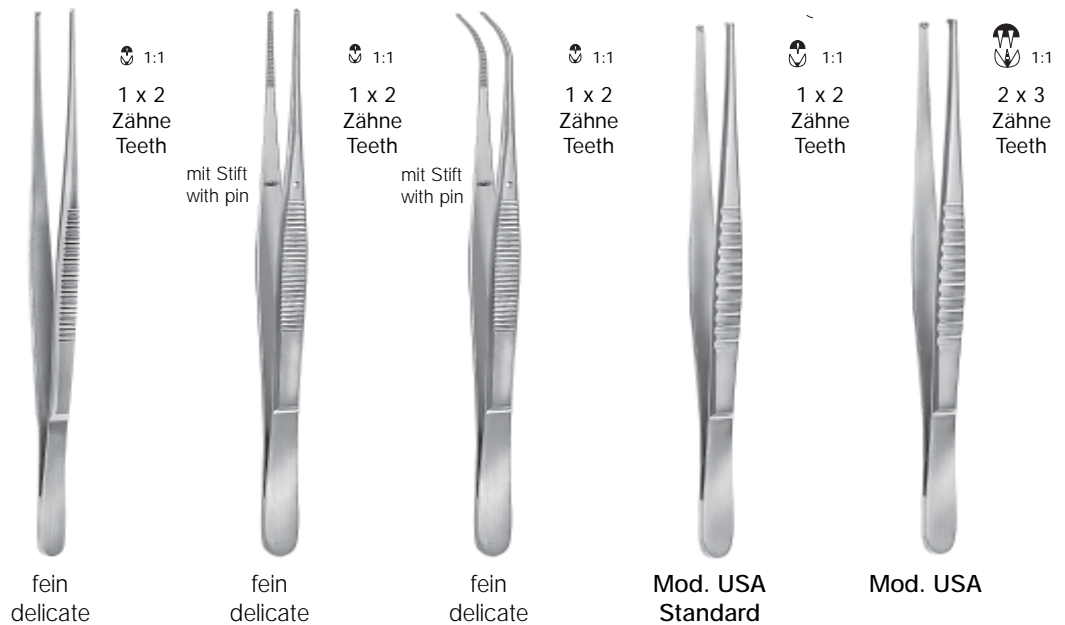

12.0 cm, 4 3/4"			130-121-120	130-126-120	130-127-120
13.0 cm, 5"	130-120-130	130-118-130	130-121-130	130-126-130	130-127-130
14.5 cm, 5 3/4"	130-120-145	130-118-145	130-121-145	130-126-145	130-127-145
15.5 cm, 6"	130-120-155	130-118-155	130-121-155	130-126-155	130-127-155
16.0 cm, 6 1/4"	130-120-160	130-118-160	130-121-160		
18.0 cm, 7"	130-120-180	130-118-180	130-121-180	130-126-180	130-127-180
20.0 cm, 8"	130-120-200	130-118-200	130-121-200	130-126-200	130-127-200
25.0 cm, 10"	130-120-250	130-118-250	130-121-250	130-126-250	130-127-250
30.0 cm, 12"	130-120-300	130-118-300	130-121-300	130-126-300	130-127-300

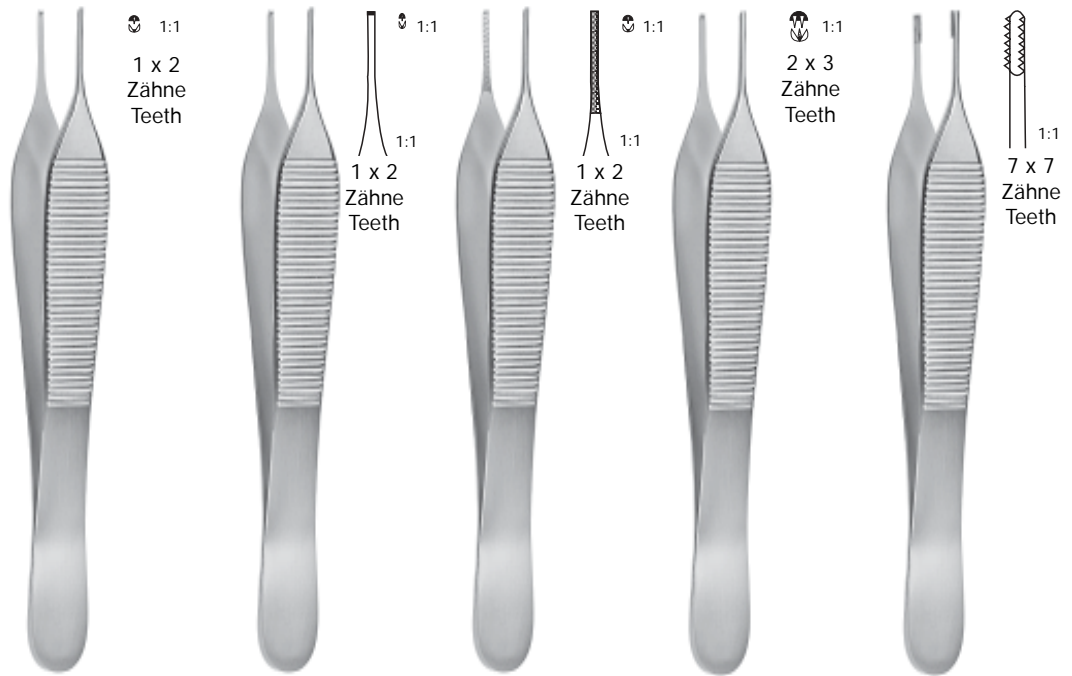

	Adson	Micro-Adson	Adson	Adson	Adson-Brown
12.0 cm, 4 3/4"	130-140-120	130-550-120	130-557-120	130-555-120	130-552-120
15.0 cm, 6"	130-140-150	130-550-150		130-555-150	130-552-150

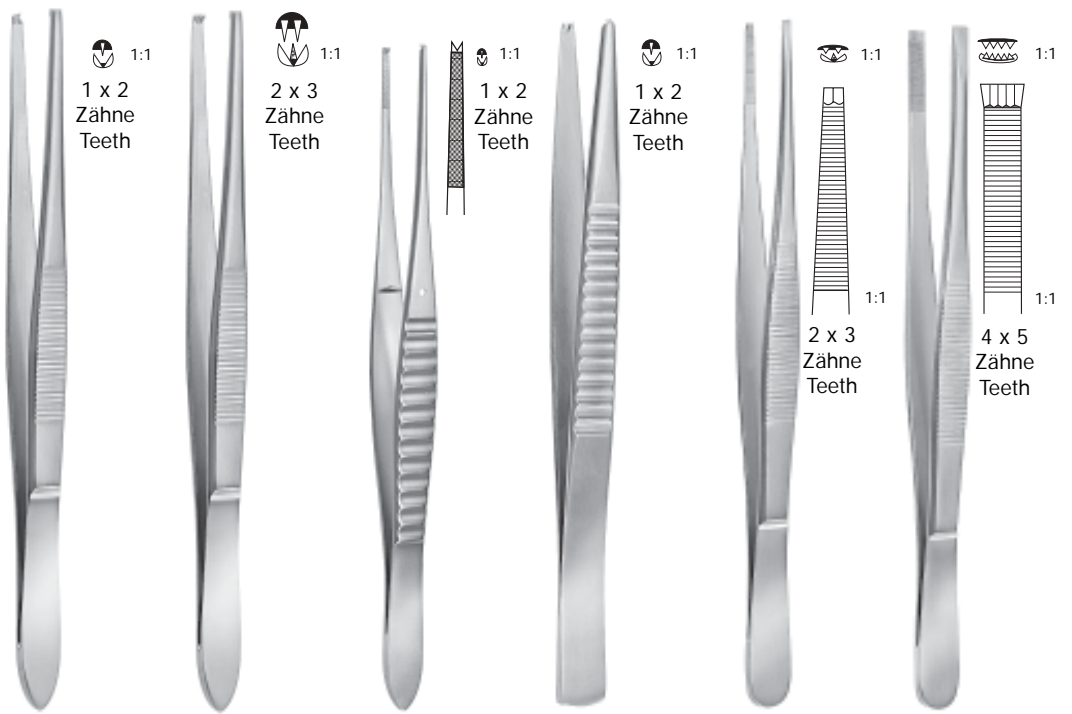

Stille                      Stille                      Gillies                      engl. Modell  
English pattern                      Adlerkreuz                      Adlerkreuz

13.0 cm, 5"				130-274-130		
14.5 cm, 5 3/4"				130-274-145		
15.0 cm, 6"	130-122-150	130-124-150	130-120-150	130-274-150	130-137-150	130-138-150
20.0 cm, 8"					130-137-200	130-138-200

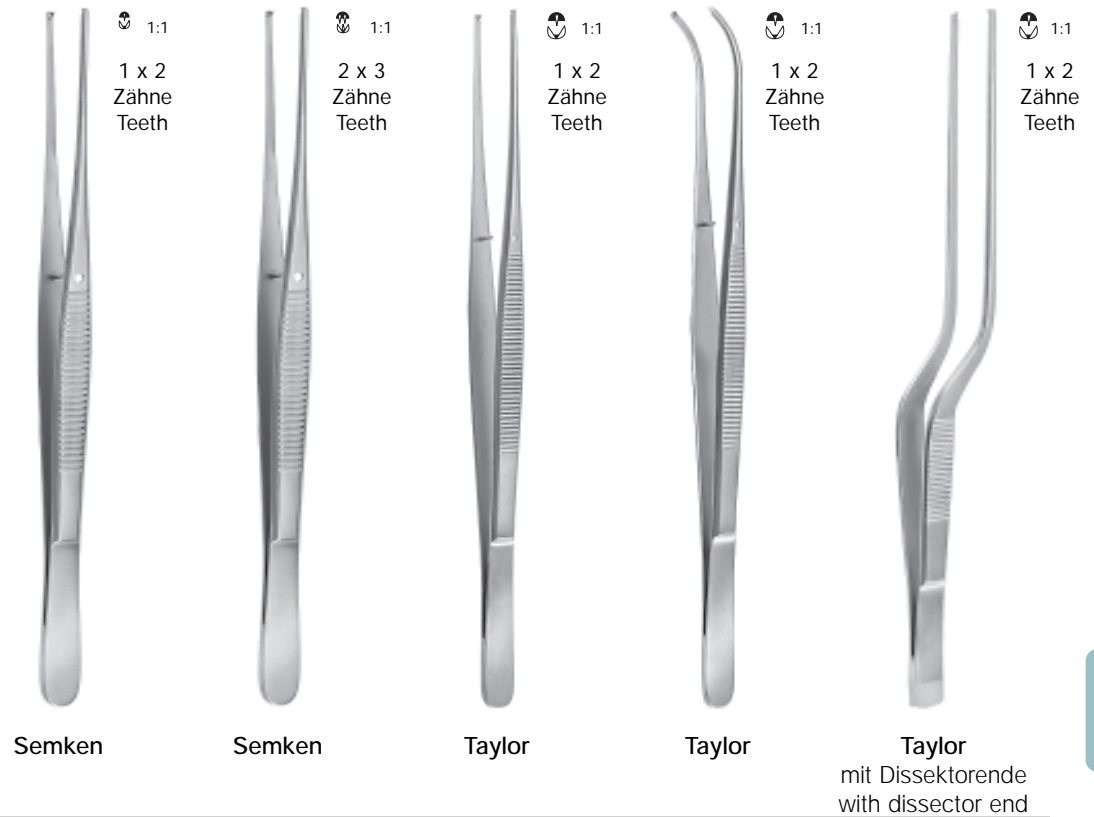

12.5 cm, 5"	130-145-125	130-147-125		
15.5 cm, 6"	130-145-150			
17.5 cm, 6 5/8"		130-147-175	130-149-175	130-157-175

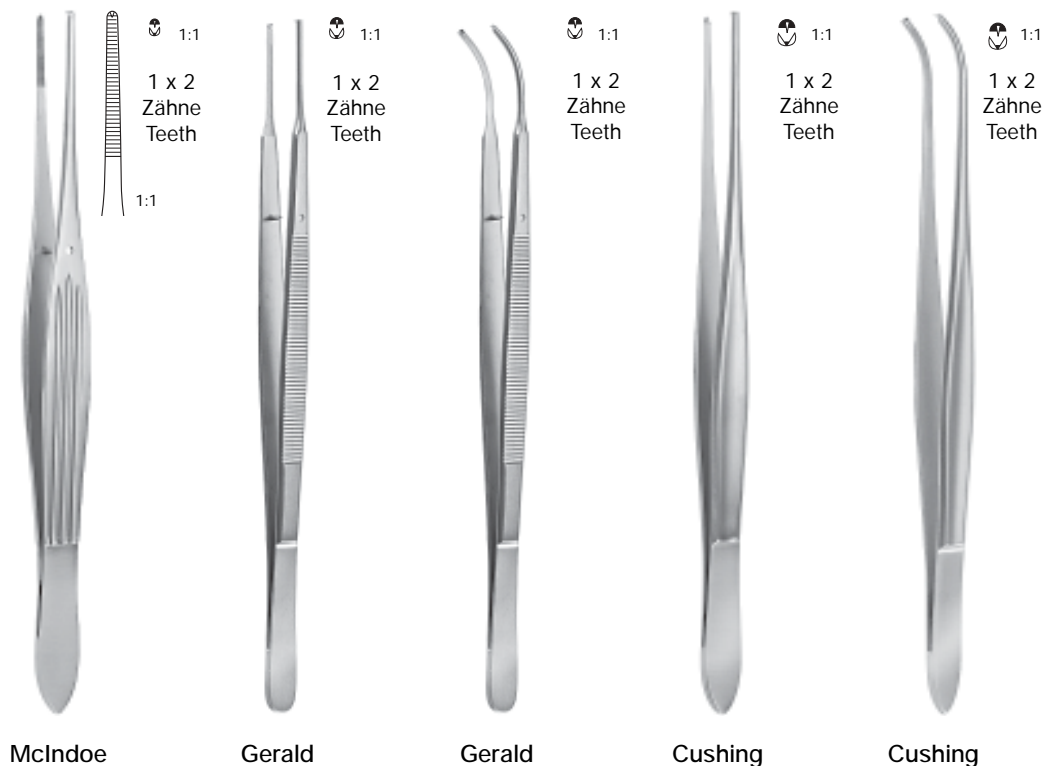

15.0 cm, 6"	130-041-150			
17.5 cm, 6 5/8"			130-152-175	130-153-175
18.0 cm, 7"		130-150-180	130-151-180	

4

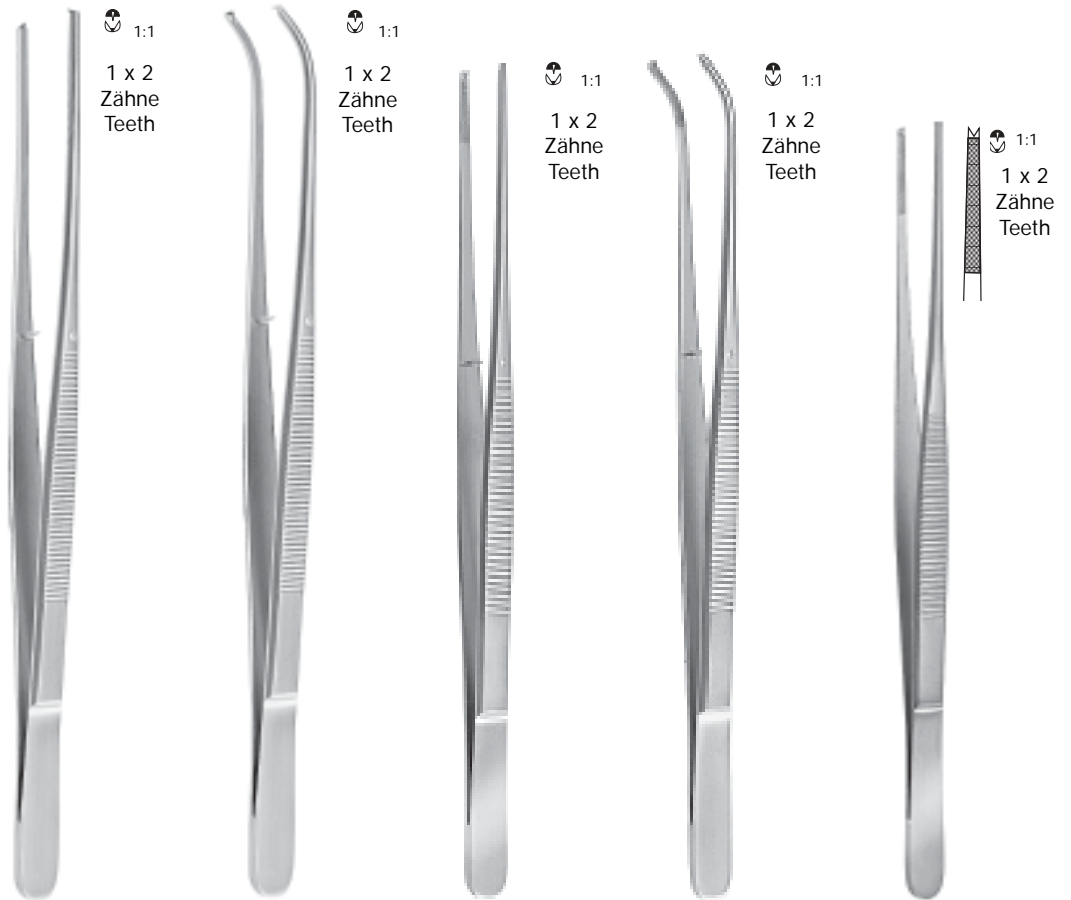

	Potts-Smith	Potts-Smith	Brophy	Brophy	Waugh
15.0 cm, 6"					130-160-150
18.0 cm, 7"	130-154-180	130-155-180			
20.0 cm, 8"			130-034-200	130-035-200	130-160-200
21.0 cm, 8 1/4"	130-154-210	130-155-210			
25.0 cm, 10"	130-154-250	130-155-250			

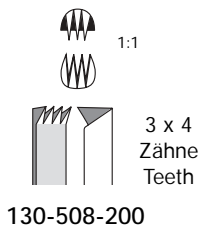
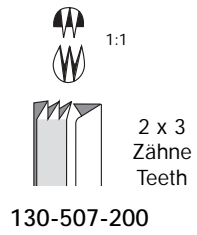
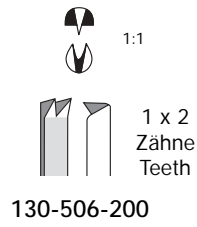

Duehrssen  
20.0 cm, 8"



	Russ. Modell	Durante
14.5 cm, 5 3/4"		130-511-145
15.0 cm, 6"	130-510-150	
16.0 cm, 6 1/4"		130-511-160
20.0 cm, 8"	130-510-200	130-511-200
25.0 cm, 10"	130-510-250	

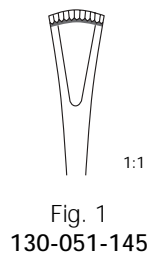

Duval  
14.0 cm, 5 1/2"

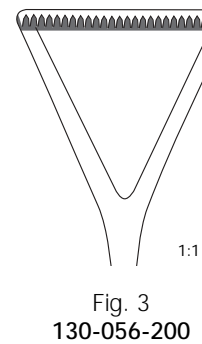
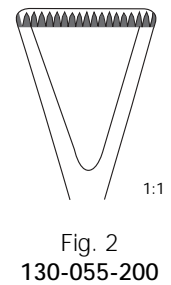

Collin-Duval  
20.0 cm, 8"

4



1:1  
1 x 2  
Zähne  
Teeth

Lane



1:1  
2 x 3  
Zähne  
Teeth

Lane



1:1  
7 x 7  
Zähne  
Teeth

Brown



1:1  
1 x 2  
Zähne  
Teeth

Treves

13.0 cm, 5"				130-119-130
14.5 cm, 5 3/4"	130-130-145	130-131-145		
15.0 cm, 6"			130-554-160	130-119-150
20.0 cm, 8"	130-130-200	130-131-200	130-554-200	

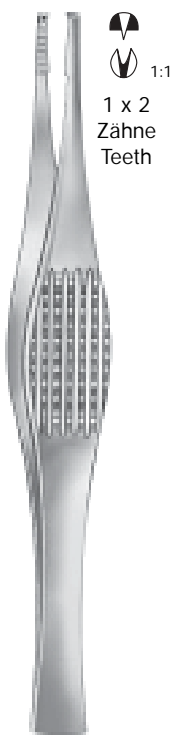

1:1  
1 x 2  
Zähne  
Teeth

Ramsey

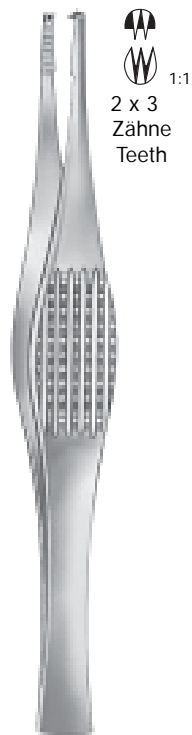

1:1  
2 x 3  
Zähne  
Teeth

Ramsey



1:1  
1 x 2  
Zähne  
Teeth

Bonney



1:1  
2 x 3  
Zähne  
Teeth

Bonney



1:1

Nelson

15.0 cm, 6"				130-562-150
18.0 cm, 7"	130-138-180	130-139-180	130-143-180	130-145-180
20.0 cm, 8"				130-562-200
23.0 cm, 9"				130-562-230

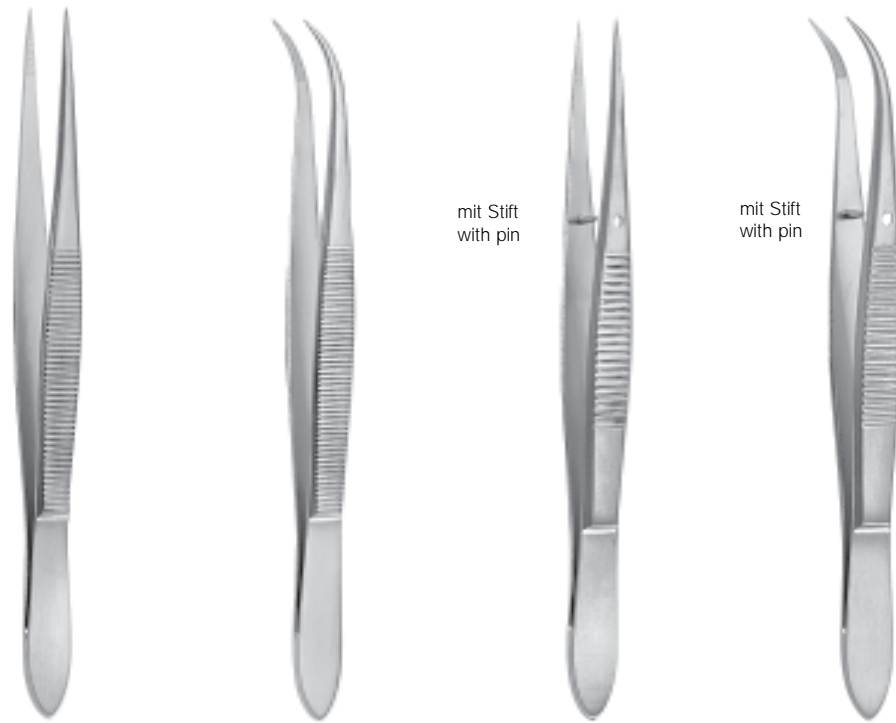

8.0 cm, 3 1/4"	130-622-080	130-623-080	130-625-080	130-627-080
9.0 cm, 3 1/2"	130-622-090	130-623-090	130-625-090	130-627-090
10.5 cm, 4 1/4"	130-622-105	130-623-105	130-625-105	130-627-105
11.5 cm, 4 1/2"	130-622-115	130-623-115	130-625-115	130-627-115
13.0 cm, 5"	130-622-130	130-623-130	130-625-130	130-627-130
14.5 cm, 5 1/2"	130-622-145	130-623-145	130-625-145	130-627-145

4



	Feilchenfeld	Hunter	Hunter	Walter-Carmalt	Walter-Carmalt
8.0 cm, 3 1/4"	130-630-075				
9.0 cm, 3 1/2"	130-630-090				
10.5 cm, 4 1/4"		130-624-105	130-626-105	130-632-105	130-633-105
11.5 cm, 4 1/2"	130-630-115				



4

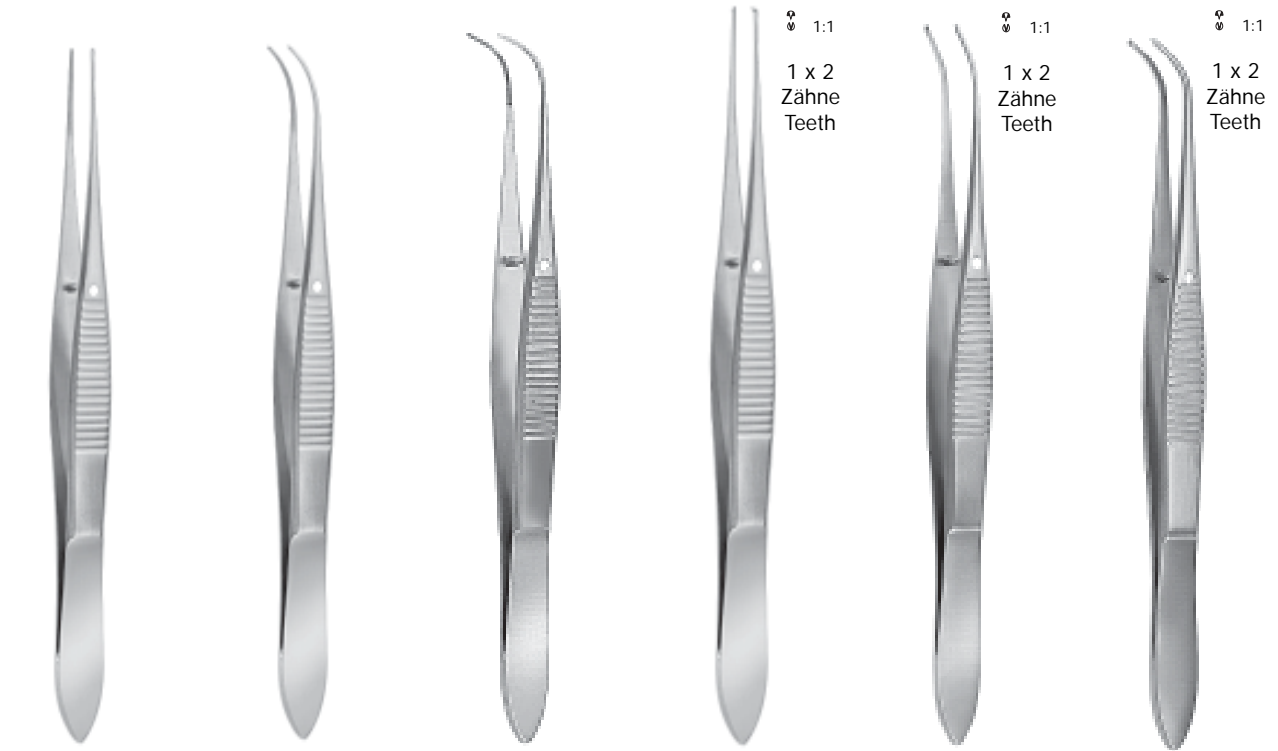

10.0 cm, 4"  
130-500-100

10.0 cm, 4"  
130-501-100

10.0 cm, 4"  
130-502-100

10.0 cm, 4"  
130-503-100

10.0 cm, 4"  
130-504-100

10.0 cm, 4"  
130-505-100

1 x 2  
Zähne  
Teeth

1 x 2  
Zähne  
Teeth

1 x 2  
Zähne  
Teeth

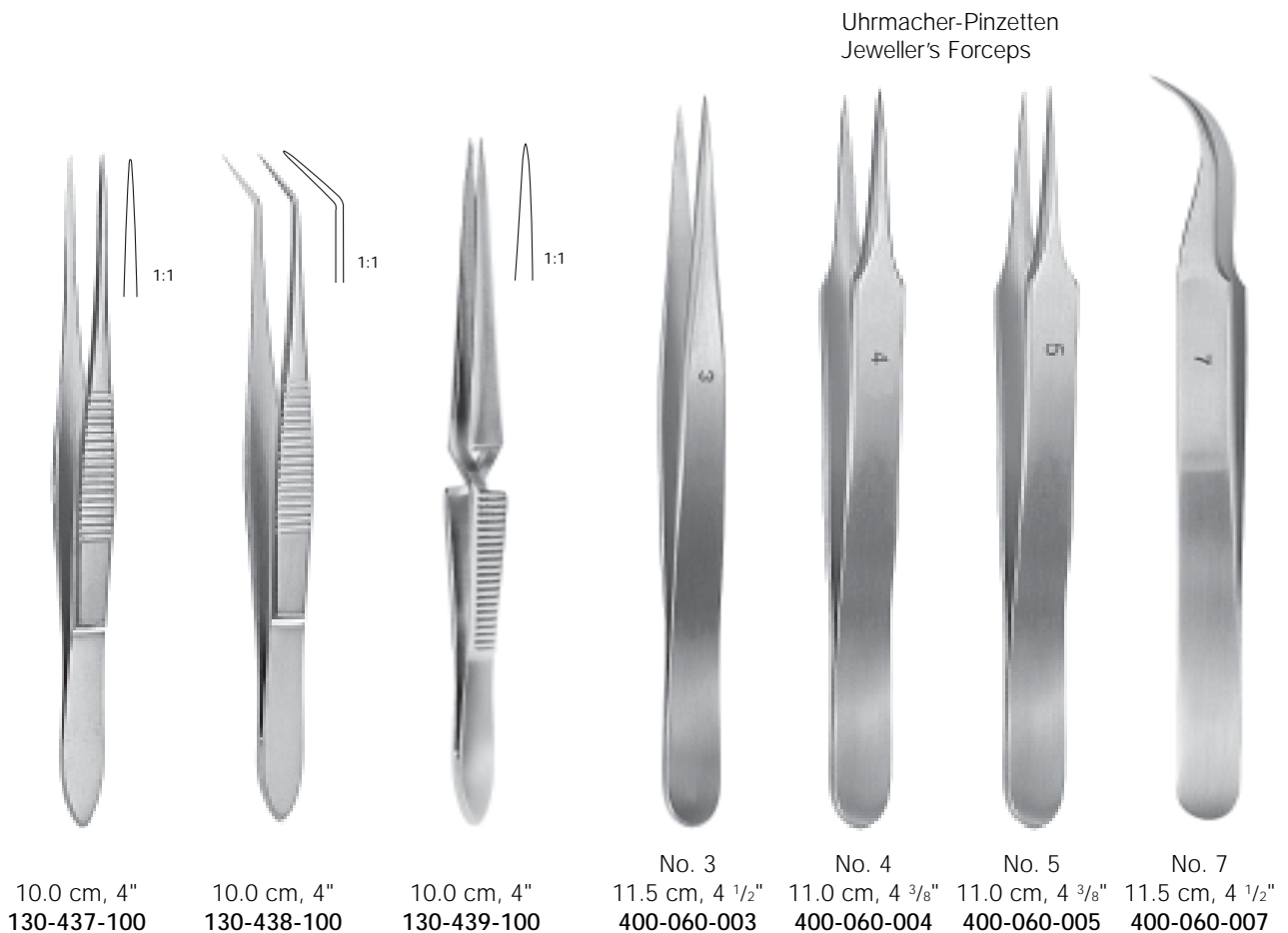

Uhrmacher-Pinzetten  
Jeweller's Forceps

10.0 cm, 4"  
130-437-100

10.0 cm, 4"  
130-438-100

10.0 cm, 4"  
130-439-100

No. 3  
11.5 cm, 4 1/2"  
400-060-003

No. 4  
11.0 cm, 4 3/8"  
400-060-004

No. 5  
11.0 cm, 4 3/8"  
400-060-005

No. 7  
11.5 cm, 4 1/2"  
400-060-007





Abgewinkelte Gefäßdilatoren können sowohl als Nadelhalter als auch als Nahtpinzetten verwendet werden. Um bessere Eigenschaften beim Halten eines Objektes zu erreichen, kann man die Spitzen dieser Pinzetten mit Diamantstaub beschichten.

Angled vessel dilators can be used as needle holders or tying forceps. All forceps can be modified to include diamond dust on tip for superior holding characteristic.



gerade, straight  
Spitze 0.3 mm ø  
Tip 0.3 mm ø

9 mm breit  
9 mm wide  
13.5 cm, 5 3/8"  
251-611-130



gerade, straight  
Spitze 0.3 mm ø  
Tip 0.3 mm ø

7 mm breit  
7 mm wide  
13.5 cm, 5 3/8"  
251-612-130



gerade, straight  
Spitze 0.3 mm ø  
Tip 0.3 mm ø

9 mm breit  
9 mm wide  
12.0 cm, 4 3/4"  
251-611-120



45° abgewinkelt,  
45°angled  
Spitze 0.3 mm ø  
Tip 0.3 mm ø

9 mm breit  
9 mm wide  
13.5 cm, 5 3/8"  
251-614-130



45° abgewinkelt,  
45°angled  
Spitze 0.3 mm ø  
Tip 0.3 mm ø

7 mm breit  
7 mm wide  
13.5 cm, 5 3/8"  
251-615-130



45° abgewinkelt,  
45°angled  
Spitze 0.3 mm ø  
Tip 0.3 mm ø

9 mm breit  
9 mm wide  
11.0 cm, 4 3/8"  
251-616-110



90° abgewinkelt,  
90°angled  
Spitze 0.3 mm ø  
Tip 0.3 mm ø

9 mm breit  
9 mm wide  
11.0 cm, 4 3/8"  
251-617-110



gerade, straight  
Spitze 0.3 mm ø  
Tip 0.3 mm ø

9 mm breit  
9 mm wide  
11.0 cm, 4 3/8"  
251-613-110



45° abgewinkelt  
diamantiert,  
45°angled  
diamond dusted  
Spitze 0.3 mm ø  
Tip 0.3 mm ø

9 mm breit  
9 mm wide  
11.0 cm, 4 3/8"  
251-619-110



gebogen, curved  
Spitze 0.4 mm ø  
Tip 0.4 mm ø

9 mm breit  
9 mm wide  
12.0 cm, 4 3/4"  
251-618-120

4



4



DeBakey



1.5 mm

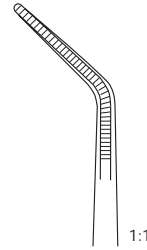

1.5 mm

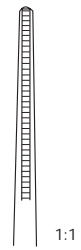

2.0 mm

16.0 cm, 6 1/4"	290-550-160	290-551-160	290-552-160
20.0 cm, 8"	290-550-200	290-551-200	290-552-200
24.0 cm, 9 1/2"	290-550-240	290-551-240	290-552-240
30.0 cm, 12"	290-550-300	290-551-300	290-552-300

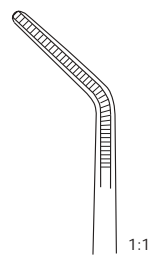

2.0 mm

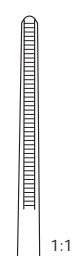

2.4 mm

16.0 cm, 6 1/4"	290-553-160	290-557-160
20.0 cm, 8"	290-553-200	290-557-200
24.0 cm, 9 1/2"	290-553-240	290-557-240
30.0 cm, 12"	290-553-300	290-557-300



DeBakey

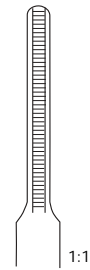
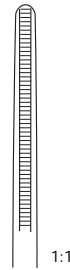

	2.8 mm	2.8 mm
16.0 cm, 6 1/4"	290-548-160	290-558-160
20.0 cm, 8"	290-548-200	290-558-200
24.0 cm, 9 1/2"	290-548-240	290-558-240
30.0 cm, 12"	290-548-300	290-558-300

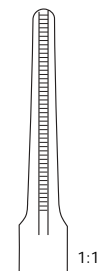
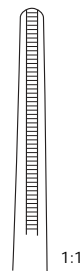

	3.5 mm	3.5 mm
16.0 cm, 6 1/4"	290-554-160	290-555-160
20.0 cm, 8"	290-554-200	290-555-200
24.0 cm, 9 1/2"	290-554-240	290-555-240
30.0 cm, 12"	290-554-300	290-555-300



Die RZ-Grip Hartmetalleinlagen zeichnen sich durch ein Grundprofil aus, welches ein gutes Festhalten des Gewebes gewährleistet.

The RZ-Grip tungsten carbide inserts feature a fine structure ensuring improved tissue grip.

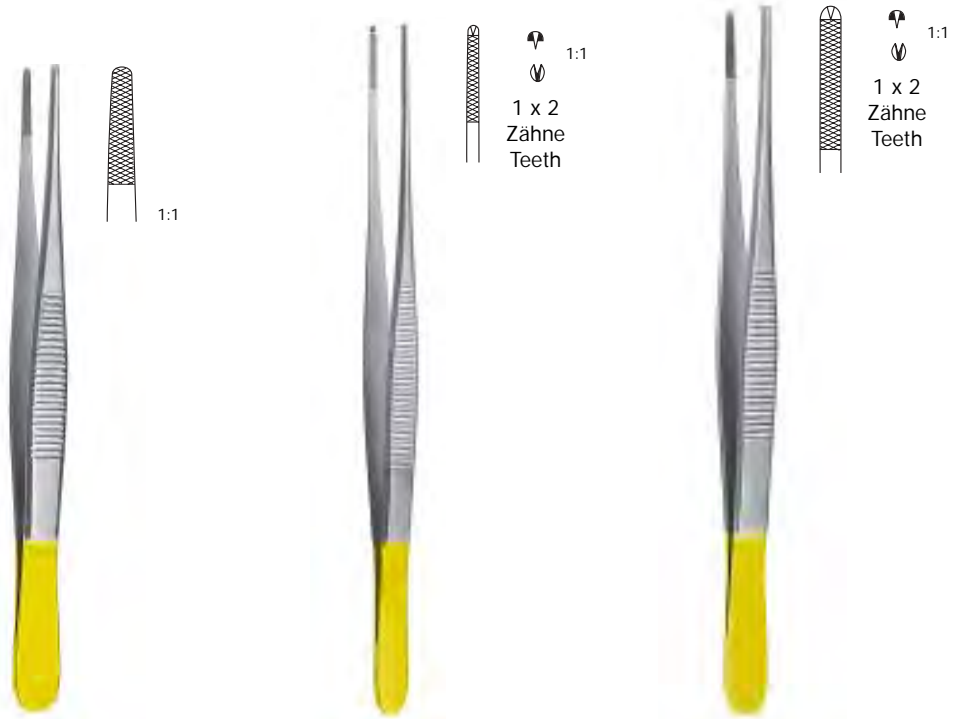
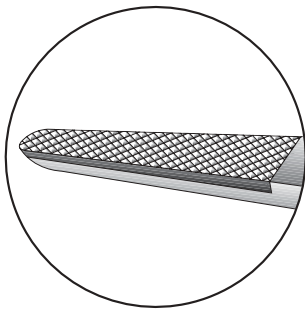

Standard

Semken

Oehler

14.0 cm, 5 1/2"		130-522-140
14.5 cm, 5 3/4"	130-518-145	
16.0 cm, 6 1/4"	130-518-160	130-522-160
18.0 cm, 7"	130-518-180	130-522-180
20.0 cm, 8"	130-518-200	130-522-200
25.0 cm, 9 3/4"	130-518-250	130-522-250
30.0 cm, 12"	130-518-300	130-522-300

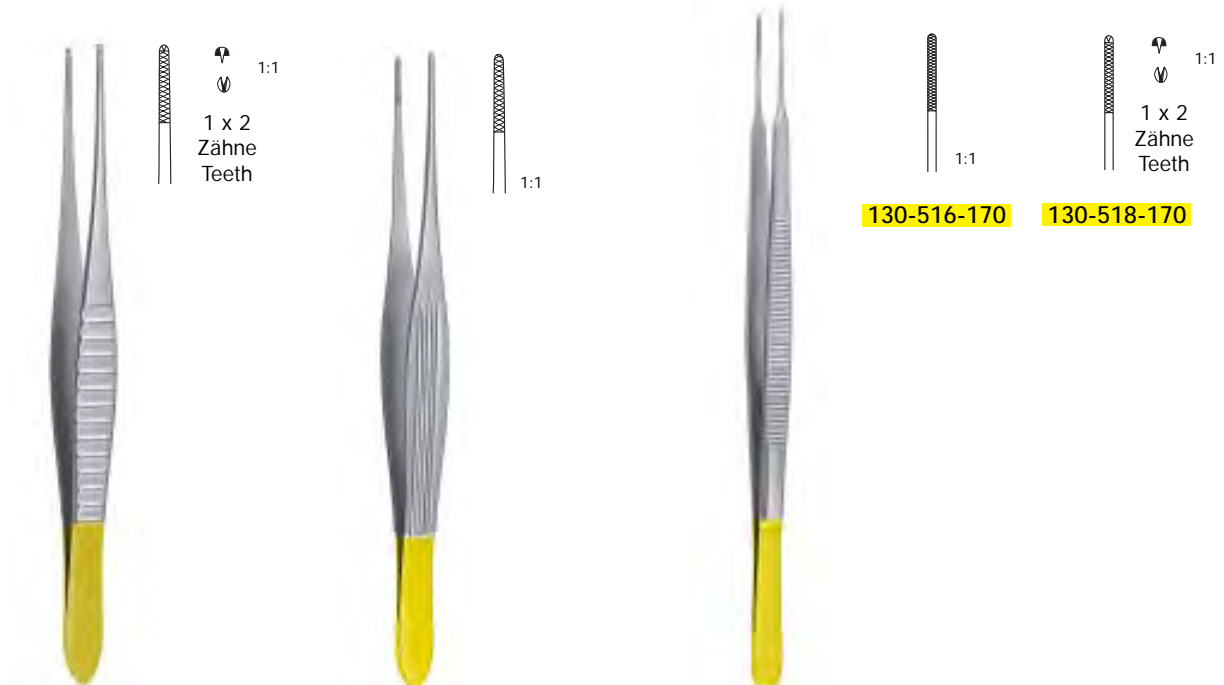

Gillies

15.0 cm, 6"  
130-520-150

Mc Indoe

15.0 cm, 6"  
130-522-150

Gerald

17.0 cm, 6 3/4"

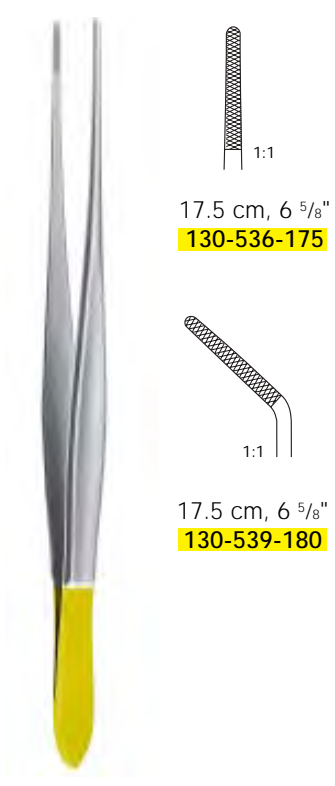

17.5 cm, 6 5/8"  
**130-536-175**

17.5 cm, 6 5/8"  
**130-539-180**

Cushing



Cushing-Taylor  
18.0 cm, 7"  
**130-541-180**



Potts-Smith

4

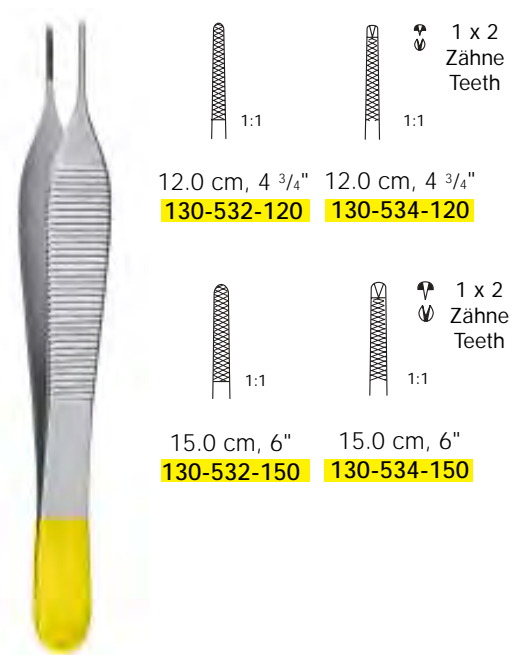

12.0 cm, 4 3/4" **130-532-120**    12.0 cm, 4 3/4" **130-534-120**

15.0 cm, 6" **130-532-150**    15.0 cm, 6" **130-534-150**

1 x 2 Zähne  
Teeth

1 x 2 Zähne  
Teeth

Adson

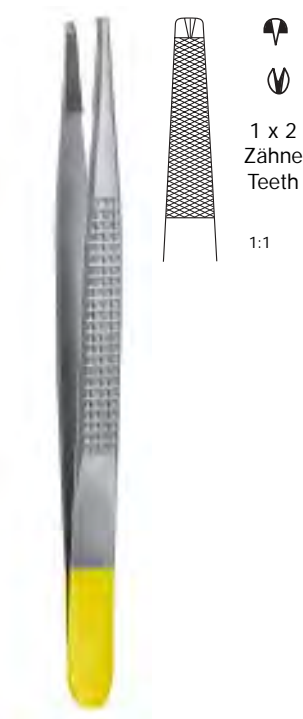

Bonney  
17.5 cm, 7"  
130-514-170



Wangenstein  
15.0 cm, 6" **130-566-150**  
23.0 cm, 9" **130-566-230**  
25.0 cm, 10" **130-566-250**



Dieffenbach

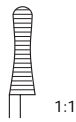

3.5 cm, 1 1/2"  
gerade, straight  
140-114-035  
5.0 cm, 2"  
gerade, straight  
140-114-050

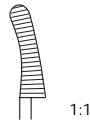

3.5 cm, 1 1/2"  
gebogen, curved  
140-115-035  
5.0 cm, 2"  
gebogen, curved  
140-115-050



Hess  
Maullänge  
length of jaw:  
2.0 cm, 3/4"  
140-056-020



Hess  
Maullänge  
length of jaw:  
3.0 cm, 1 1/8"  
140-056-030

5

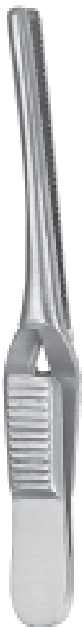

Johns-Hopkins

3.8 cm, 1 1/2"	140-050-038	140-051-038
5.0 cm, 2"	140-050-050	140-051-050
6.3 cm, 2 1/2"	140-050-063	140-051-063
7.6 cm, 3"	140-050-076	140-051-076
9.0 cm, 3 1/2"	140-050-090	140-051-090

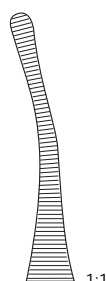
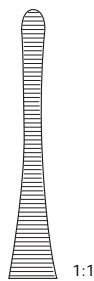

Die Johns-Hopkins An- und Ablegezange kann mit allen Bulldogklemmen, welche auf den folgenden Seiten abgebildet sind verwendet werden.

The Johns Hopkins applying and removing forceps can be used with every bulldog clamp shown on the both pages.

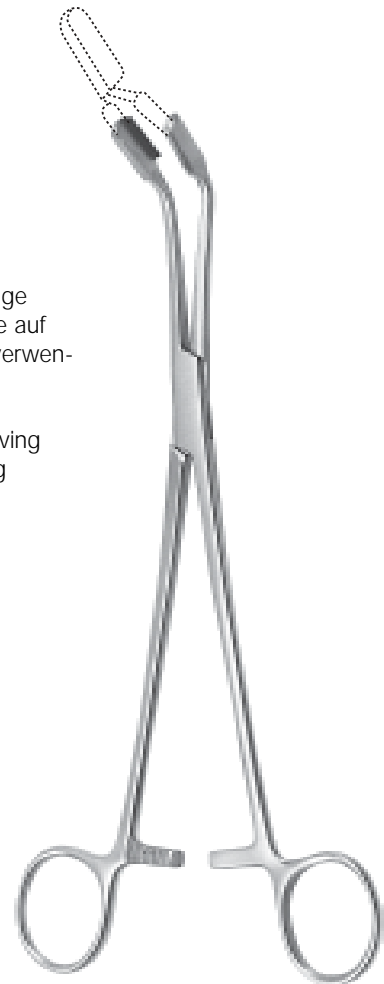

Johns-Hopkins  
23.0 cm, 9"  
140-152-230

# Allgemeines Instrumentarium

## Bulldogklemmen mit Atrauma-Zahnung

# General Instruments

## Bulldog Clamps with Atrauma Serration



Die atraumatische Zahnung schützt Gewebe sowie Gefäße vor Verletzungen und garantiert einen sicheren und standhaften Halt

Atrauma serrations prevents damage to tissue and vessels. It also ensures a safe and firm grip of tissue.



DeBakey	Gesamtlänge total length	Maullänge length of jaw
140-120-075	8.0 cm, 3 1/8"	2.5 cm, 1"
140-120-085	9.0 cm, 3 1/2"	3.5 cm, 1 3/8"
140-120-105	10.5 cm, 4 1/8"	5.0 cm, 2"
140-120-120	12.4 cm, 5"	6.8 cm, 2 3/4"

DeBakey	Gesamtlänge total length	Maullänge length of jaw
140-119-075	7.8 cm, 3 1/8"	2.5 cm, 1"
140-119-085	8.6 cm, 3 3/8"	3.5 cm, 1 3/8"
140-119-105	9.7 cm, 3 3/4"	5.0 cm, 2"
140-119-120	11.4 cm, 4 1/2"	6.8 cm, 2 3/4"



3.5 cm, 1 3/8"  
vena 140-216-035  
arteria 140-216-135

3.5 cm, 1 3/8"  
vena 140-217-035  
arteria 140-217-135

4.0 cm, 1 5/8"  
vena 140-216-040  
arteria 140-216-140

4.0 cm, 1 5/8"  
vena 140-216-040  
arteria 140-216-140



Glover	Gesamtlänge total length	Maullänge length of jaw
140-130-070	6.8 cm, 2 3/4"	3.3 cm, 1 3/8"
140-130-090	9.6 cm, 3 3/4"	5.0 cm, 2"
140-130-110	11.7 cm, 4 3/4"	6.9 cm, 2 3/4"

Glover	Gesamtlänge total length	Maullänge length of jaw
140-131-070	6.5 cm, 2 1/2"	3.3 cm, 1 3/8"
140-131-090	9.1 cm, 3 1/2"	5.0 cm, 2"
140-131-110	11.0 cm, 4 3/8"	6.9 cm, 2 3/4"

5



**Chaput**  
13.0 cm, 5"  
140-134-130



**Tuffier**  
13.0 cm, 5"  
140-135-130

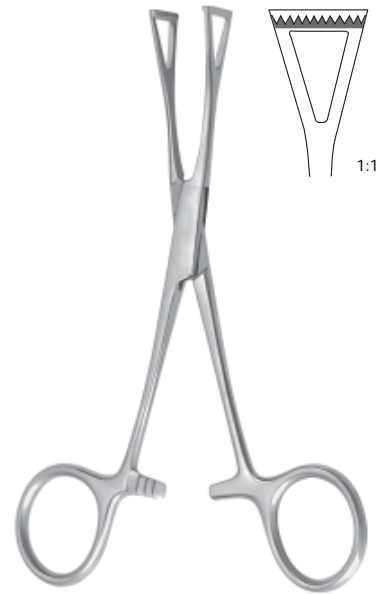

**Collin**  
14.0 cm, 5 1/2"  
140-235-140

5

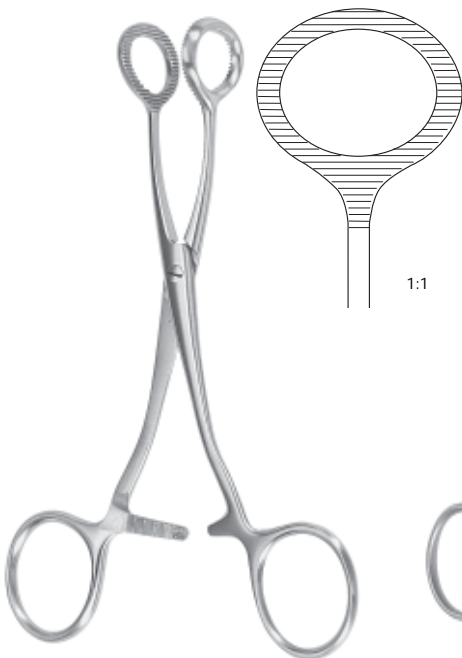

**Collin**  
16.0 cm, 6 1/4"  
140-236-160

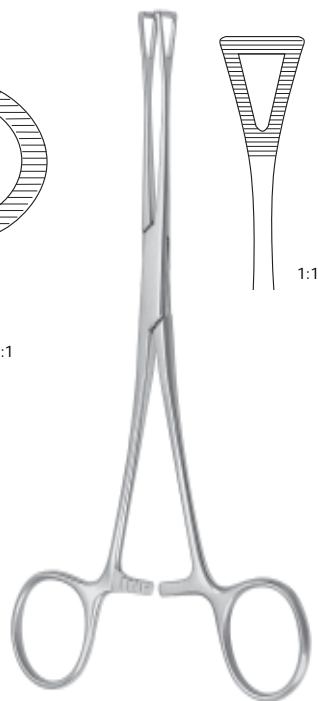

**Pennington**  
15.5 cm, 6"  
140-240-155  
20.0 cm, 8"  
140-240-200

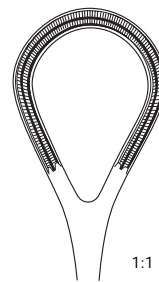

25.0 cm, 9 1/2"  
140-220-250

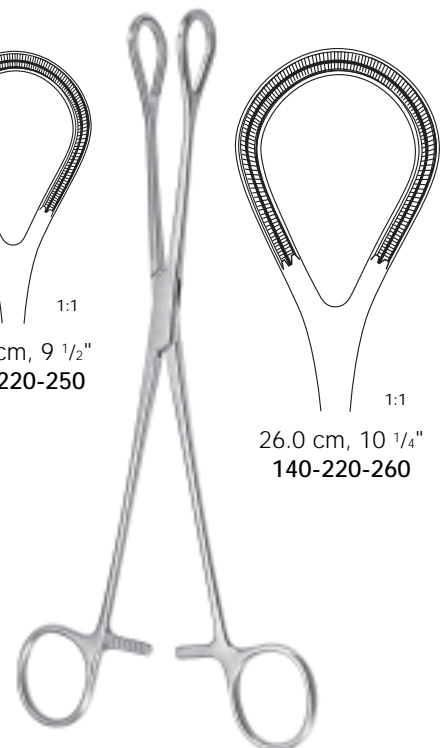

26.0 cm, 10 1/4"  
140-220-260

**Atrauma**



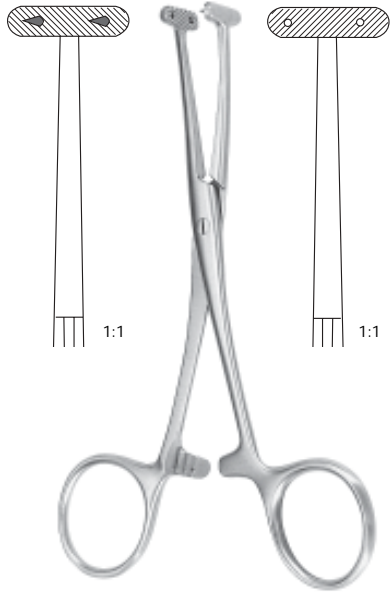

**Martel**  
14.0 cm, 5 1/2"  
140-267-140

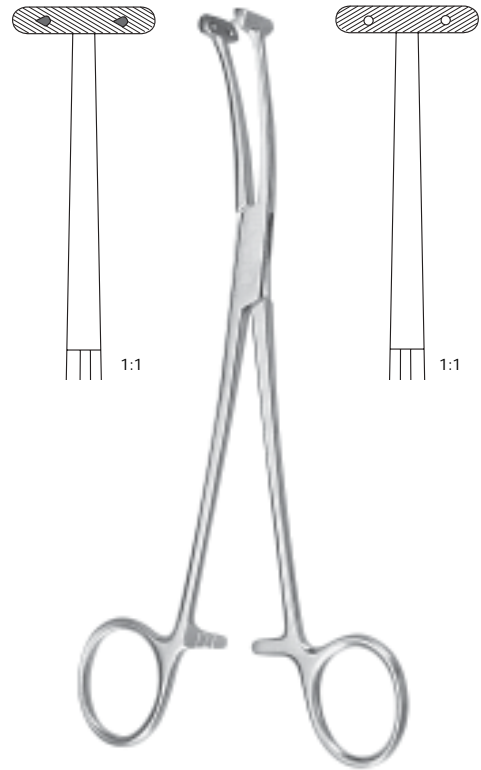

**Willet-Martel**  
19.0 cm, 7 1/2"  
140-267-190



**Pratt**  
15.0 cm, 6"  
140-282-150

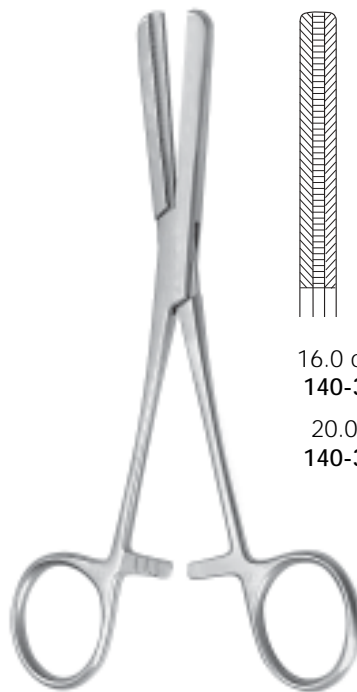

**Fergusson**

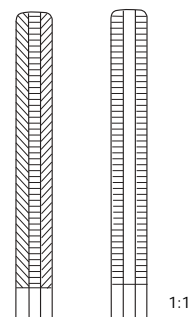

16.0 cm, 6 1/4"  
140-300-160  
20.0 cm, 8"  
140-300-200

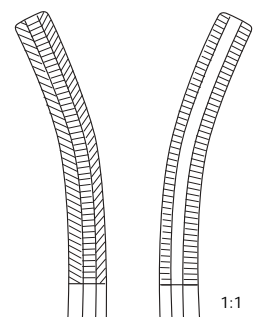

16.0 cm, 6 1/4"  
140-301-160  
20.0 cm, 8"  
140-301-200

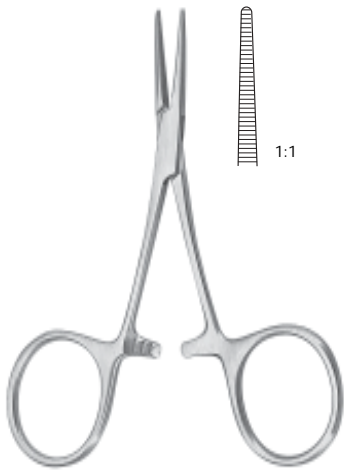

**Carrel**  
10.0 cm, 4"  
140-232-100

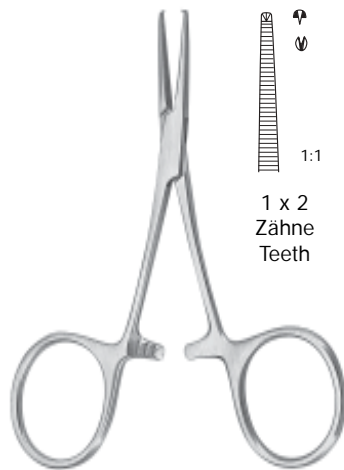

**Terrier**  
10.0 cm, 4"  
140-233-100

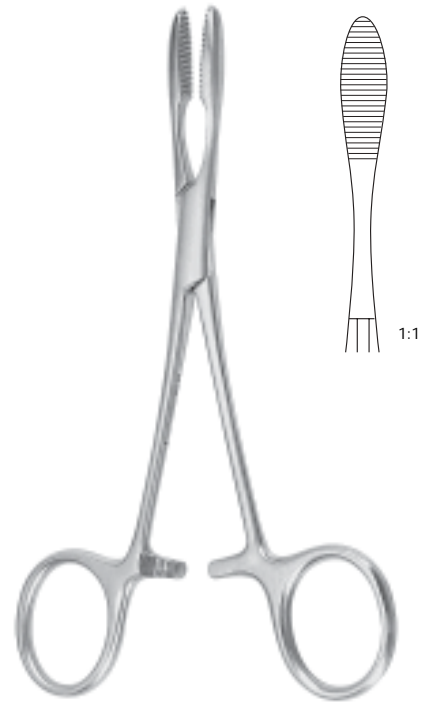

**Pean**  
14.0 mm, 5 1/2"  
140-228-140  
16.0 mm, 6 1/4"  
140-228-160

5

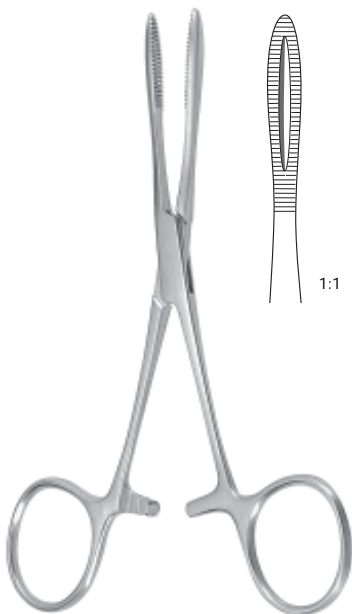

**Kroenlein**  
13.0 cm, 5"  
140-229-130

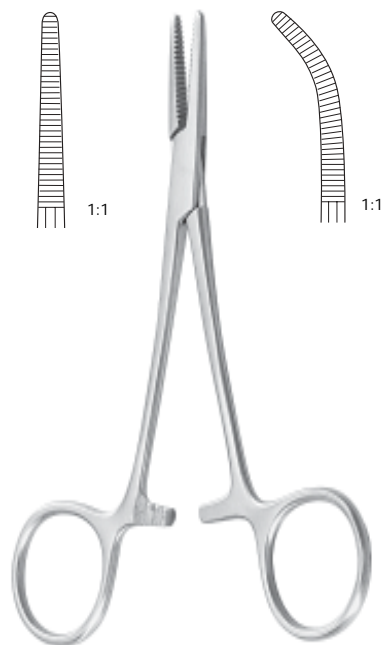

<b>Spencer-Wells</b>	gerade, straight	gebogen, curved
13.0 cm, 5"	140-150-130	140-151-130
15.0 cm, 6"	140-150-150	140-151-150
18.0 cm, 7"	140-150-180	140-151-180
20.0 cm, 8"	140-150-200	140-151-200



Baby-Mixer  
14.0 cm, 5 1/2"

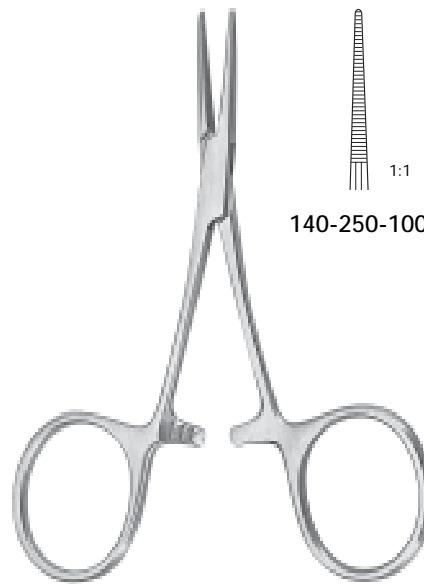
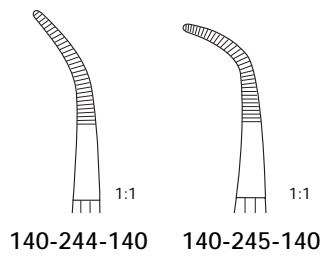

Hartmann  
10.0 cm, 4"

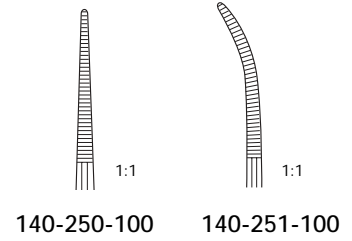

5



Halsted-Mosquito

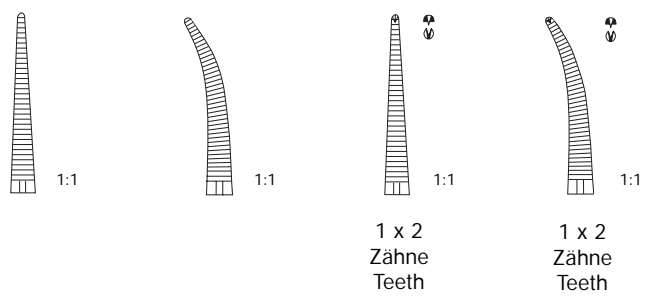

12.5 cm, 5"	140-254-125	140-255-125	140-256-125	140-257-125
14.0 cm, 5 1/2"	140-254-140	140-255-140	140-256-140	140-257-140



Halsted-Mosquito



1:1

18.0 cm, 7"  
140-254-180



1:1

18.0 cm, 7"  
140-255-180



1:1

18.0 cm, 7"  
1 x 2 Zähne / Teeth  
140-256-180

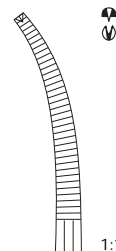

1:1

18.0 cm, 7"  
1 x 2 Zähne / Teeth  
140-257-180



1:1

21.0 cm, 8 1/4"  
140-254-210

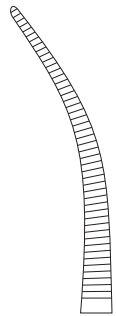

1:1

21.0 cm, 8 1/4"  
140-255-210



1:1

21.0 cm, 8 1/4"  
1 x 2 Zähne / Teeth  
140-256-210

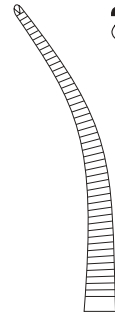

1:1

21.0 cm, 8 1/4"  
1 x 2 Zähne / Teeth  
140-257-210

5



Micro-Mosquito



1:1



1:1



1:1

1 x 2  
Zähne  
Teeth



1:1

1 x 2  
Zähne  
Teeth

10.0 cm, 4"	140-270-100	140-271-100	140-272-100	140-273-100
12.0 cm, 4 3/4"	140-270-120	140-271-120	140-272-120	140-273-120



140-274-140

Providence-Hospital  
14.0 cm, 5 1/2"

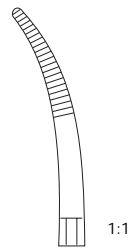

140-275-140



140-280-140

Kelly  
14.0 cm, 5 1/2"

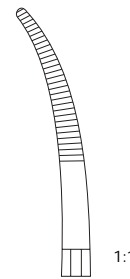

140-281-140



Leriche  
15.0 cm, 6"

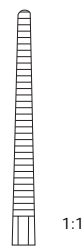

140-276-150

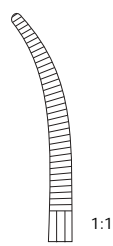

140-277-150

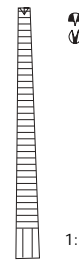

140-278-150

1 x 2  
Zähne  
Teeth

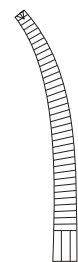

140-279-150

1 x 2  
Zähne  
Teeth



**Kelly-Rankin**  
16.0 cm, 6 1/4"

140-286-160



1:1

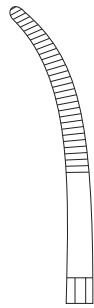

1:1

140-287-160



**Baby-Overholt**  
13.5 cm, 5 1/4"

140-285-135

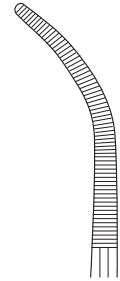

1:1

5

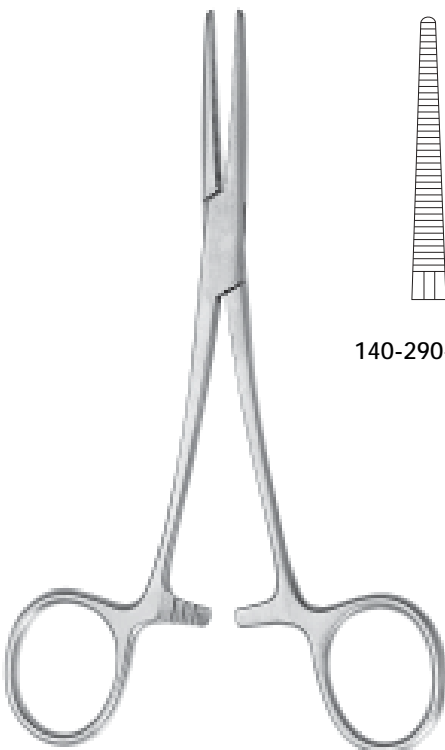

**Crile**  
14.0 cm, 5 1/2"

140-290-140

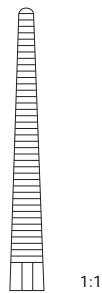

1:1

140-291-140

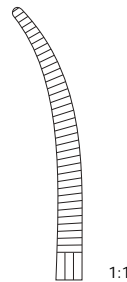

1:1

140-292-140

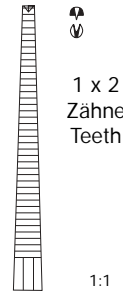

1 x 2  
Zähne  
Teeth

1:1

140-293-140

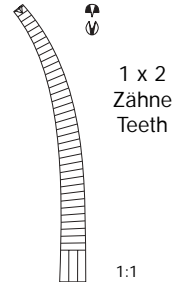

1 x 2  
Zähne  
Teeth

1:1



**Crile-Rankin**  
16.0 cm, 6 1/4"

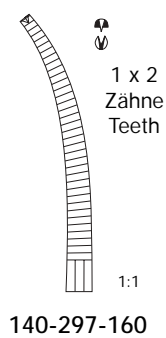
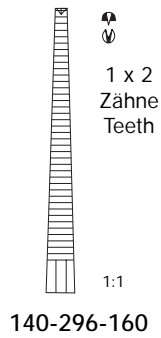
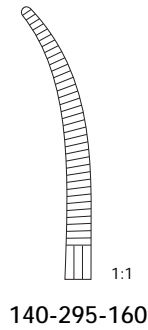
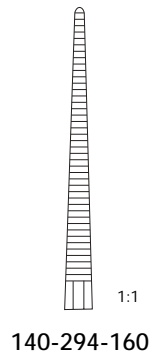

**Dixon-Lovelace**  
16.0 cm, 6 1/4"

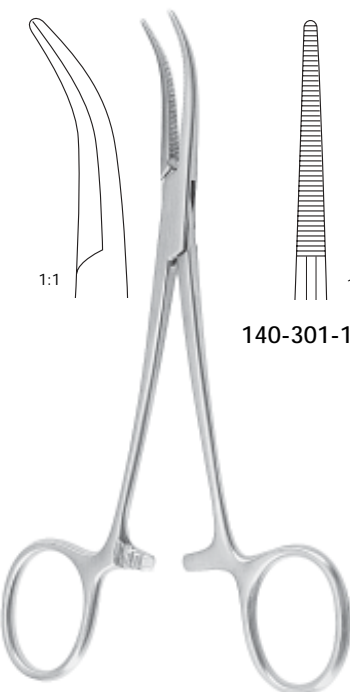
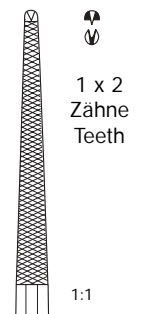
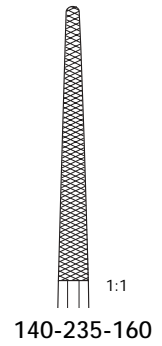

**Dandy**  
14.0 cm, 5 1/2"

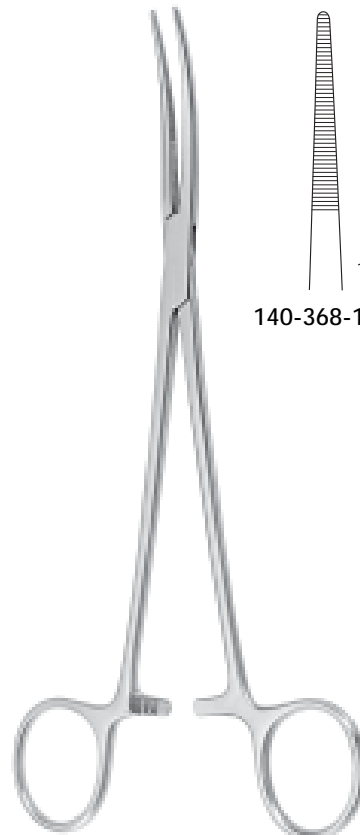
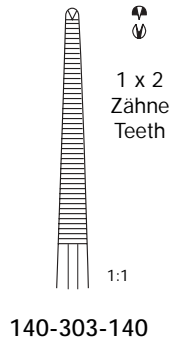
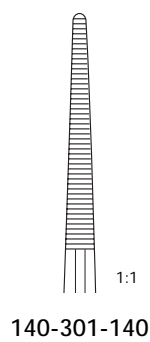
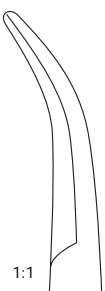

**Birkett**  
18.5 cm, 7 1/4"

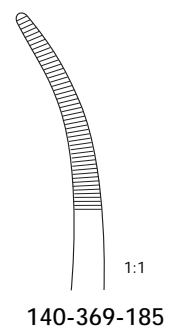
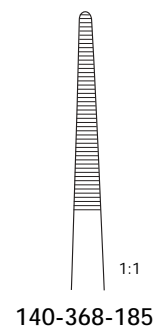

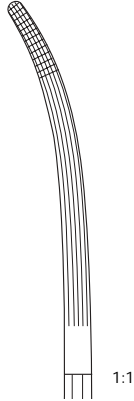
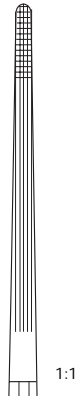
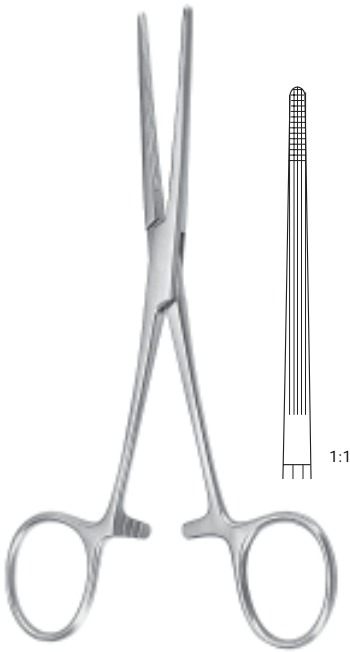

Bainbridge		
15.0 cm, 6"	140-442-150	140-443-150
18.5 cm, 7 1/4"	140-442-185	140-443-185

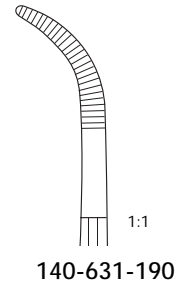
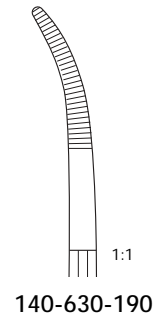
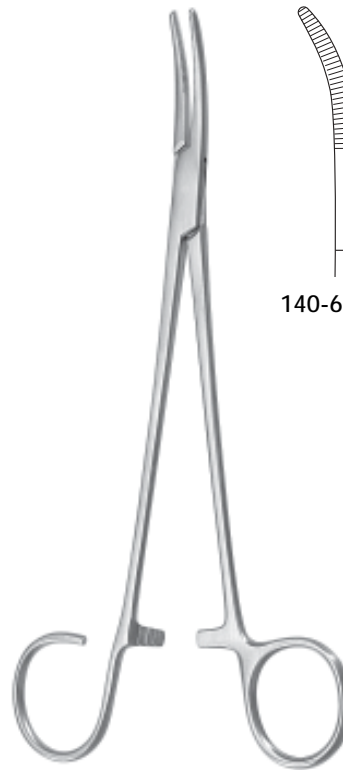

Schnidt  
19.0 cm, 7 1/2"

5

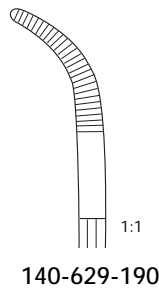
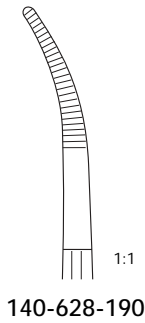
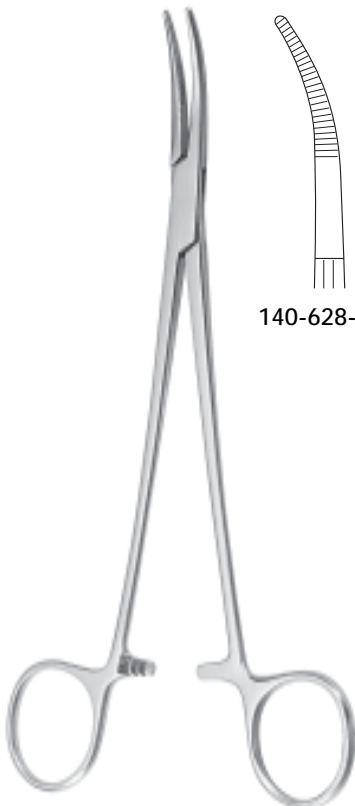

Schnidt-Sawtell  
19.0 cm, 7 1/2"

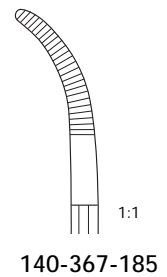
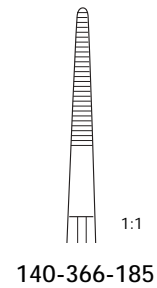
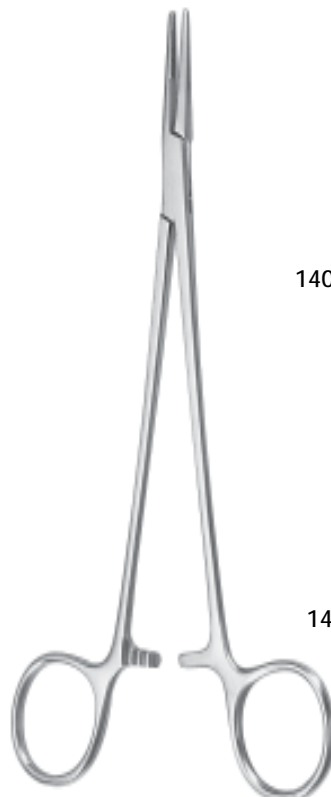

140-366-185

140-367-185

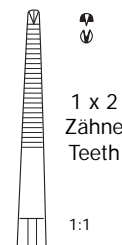

1 x 2  
Zähne  
Teeth

140-372-185

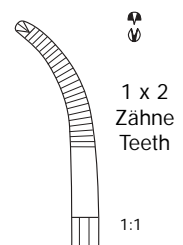

1 x 2  
Zähne  
Teeth

140-373-185

Adson  
18.5 cm, 7 1/4"





Rochester-Carmalt

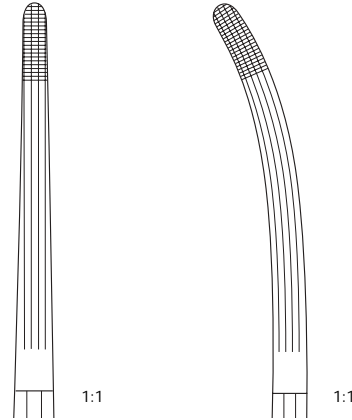

16.0 cm, 6 1/4"	140-314-160	140-315-160
20.0 cm, 8"	140-314-200	140-315-200

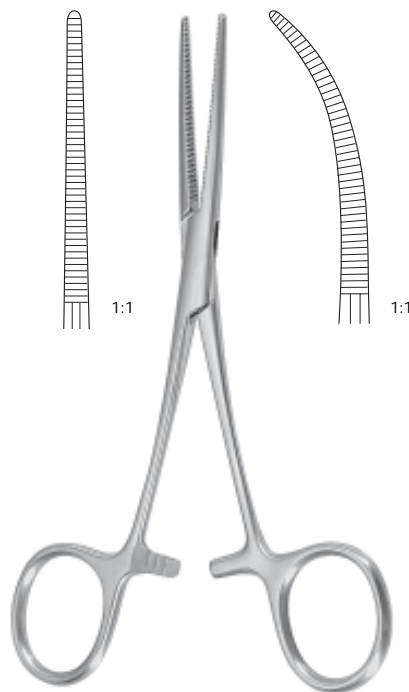

Pean delicate

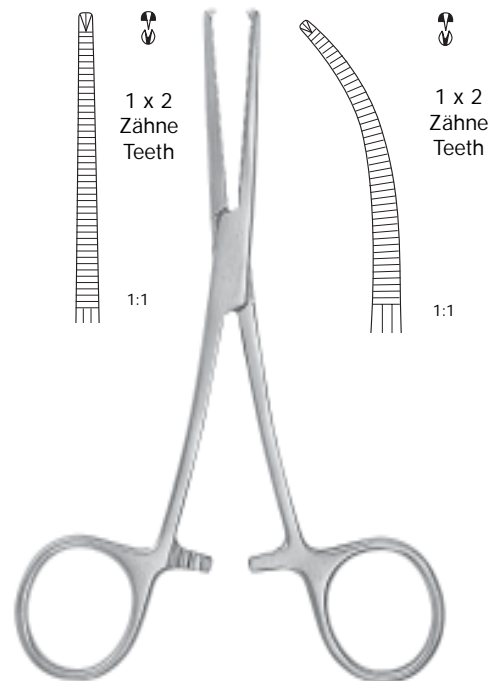

Kocher delicate

13.0 cm, 5"	140-316-130	140-317-130	140-318-130	140-319-130
14.0 cm, 5 1/2"	140-316-140	140-317-140	140-318-140	140-319-140
16.0 cm, 6 1/4"	140-316-160	140-317-160	140-318-160	140-319-160



Rochester-Pean

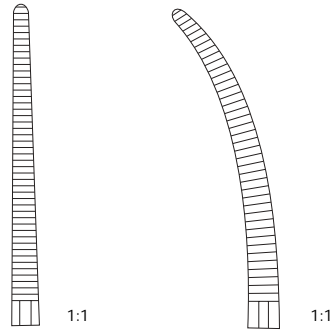

14.0 cm, 5 1/2"	140-330-140	140-331-140
16.0 cm, 6 1/4"	140-330-160	140-331-160
18.0 cm, 7"	140-330-180	140-331-180
20.0 cm, 8"	140-330-200	140-331-200
22.0 cm, 8 5/8"	140-330-220	140-331-220
24.0 cm, 9 1/2"	140-330-240	140-331-240
26.0 cm, 10 1/4"	140-330-260	140-331-260
30.0 cm, 12"	140-330-300	140-331-300

5



Kocher-Ochsner

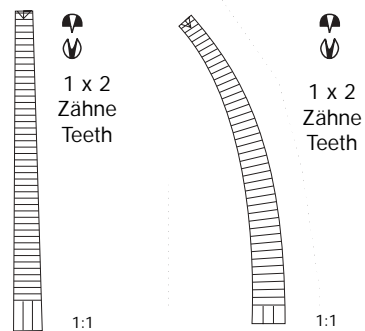

14.0 cm, 5 1/2"	140-332-140	140-333-140
16.0 cm, 6 1/4"	140-332-160	140-333-160
18.0 cm, 7"	140-332-180	140-333-180
20.0 cm, 8"	140-332-200	140-333-200
22.0 cm, 8 5/8"	140-332-220	140-333-220
24.0 cm, 9 1/2"	140-332-240	140-333-240
26.0 cm, 10 1/4"	140-332-260	140-333-260
30.0 cm, 12"	140-332-300	140-333-300

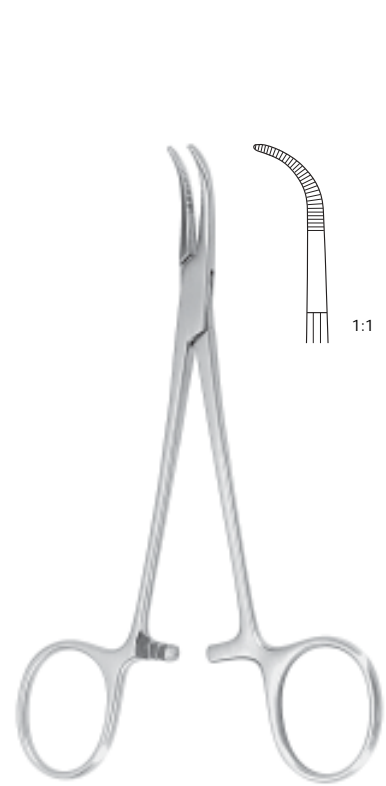

**Baby-Adson**  
 14.0 cm, 5 1/2"  
 140-339-140  
 18.0 cm, 7"  
 140-339-180



**Baby-Mixer**  
 18.0 cm, 7"  
 140-337-180



**Micro-Adson**  
 14.0 cm, 5 1/2"  
 140-338-140

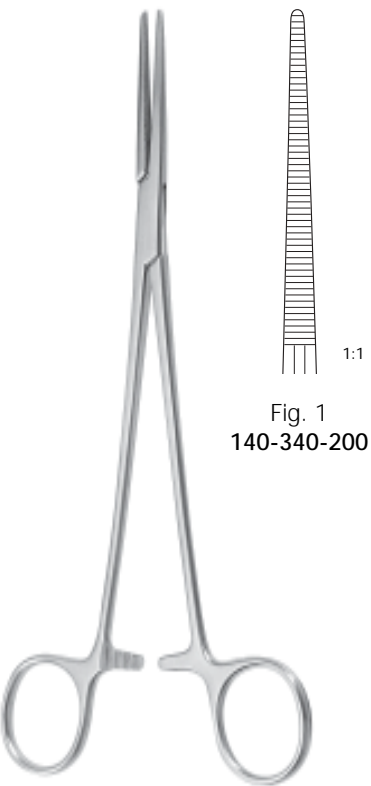

**Heiss**  
 20.0 cm, 8"

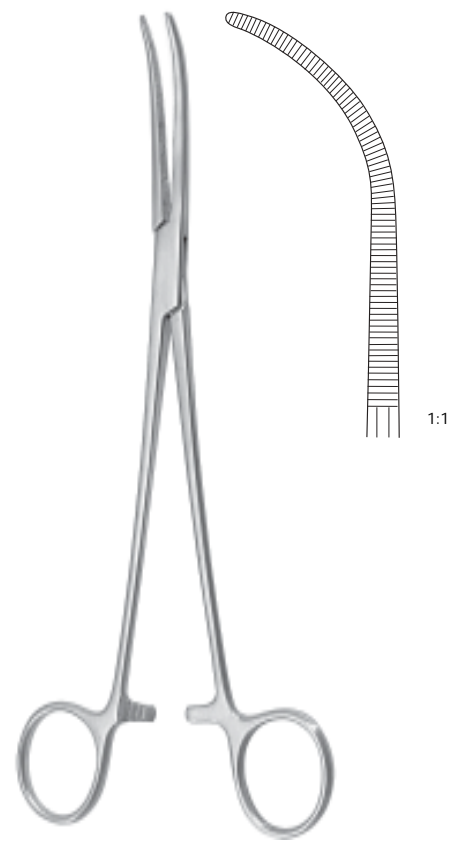
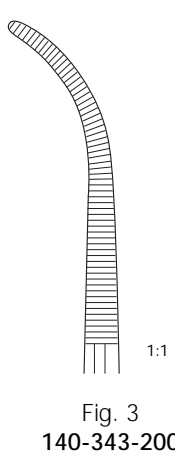
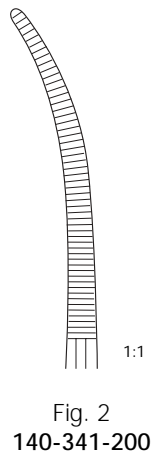
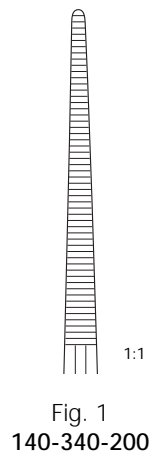

**Overholt-Mixer**  
 21.0 cm, 8 1/4"  
 140-345-210



Bengolea

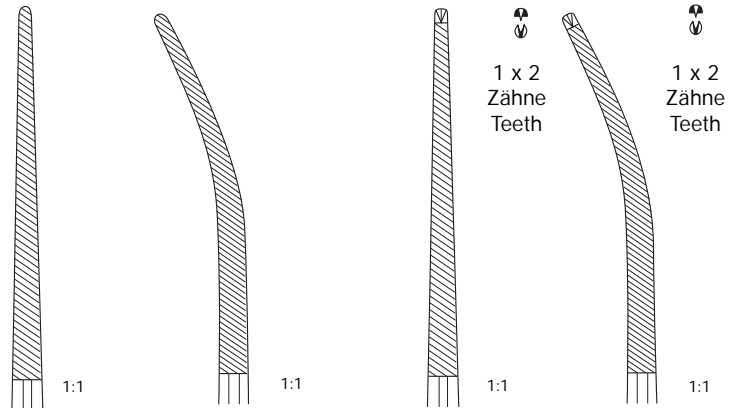

20.0 cm, 8"	140-140-200	140-141-200	140-142-200	140-143-200
26.0 cm, 10 1/4"	140-140-260	140-141-260	140-142-260	140-143-260

5



Overholt  
S-gebogen, S-curved

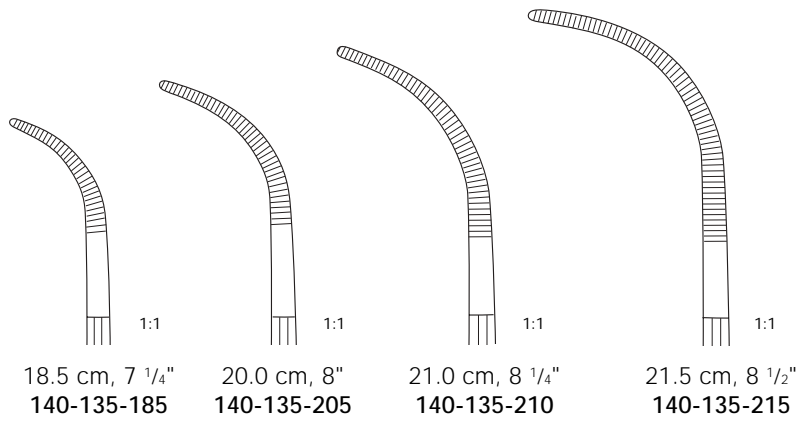

18.5 cm, 7 1/4"	20.0 cm, 8"	21.0 cm, 8 1/4"	21.5 cm, 8 1/2"
140-135-185	140-135-205	140-135-210	140-135-215

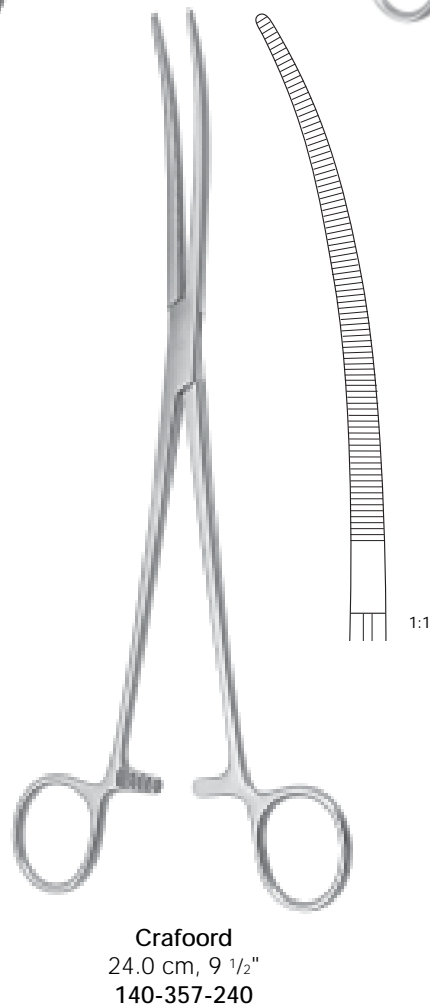
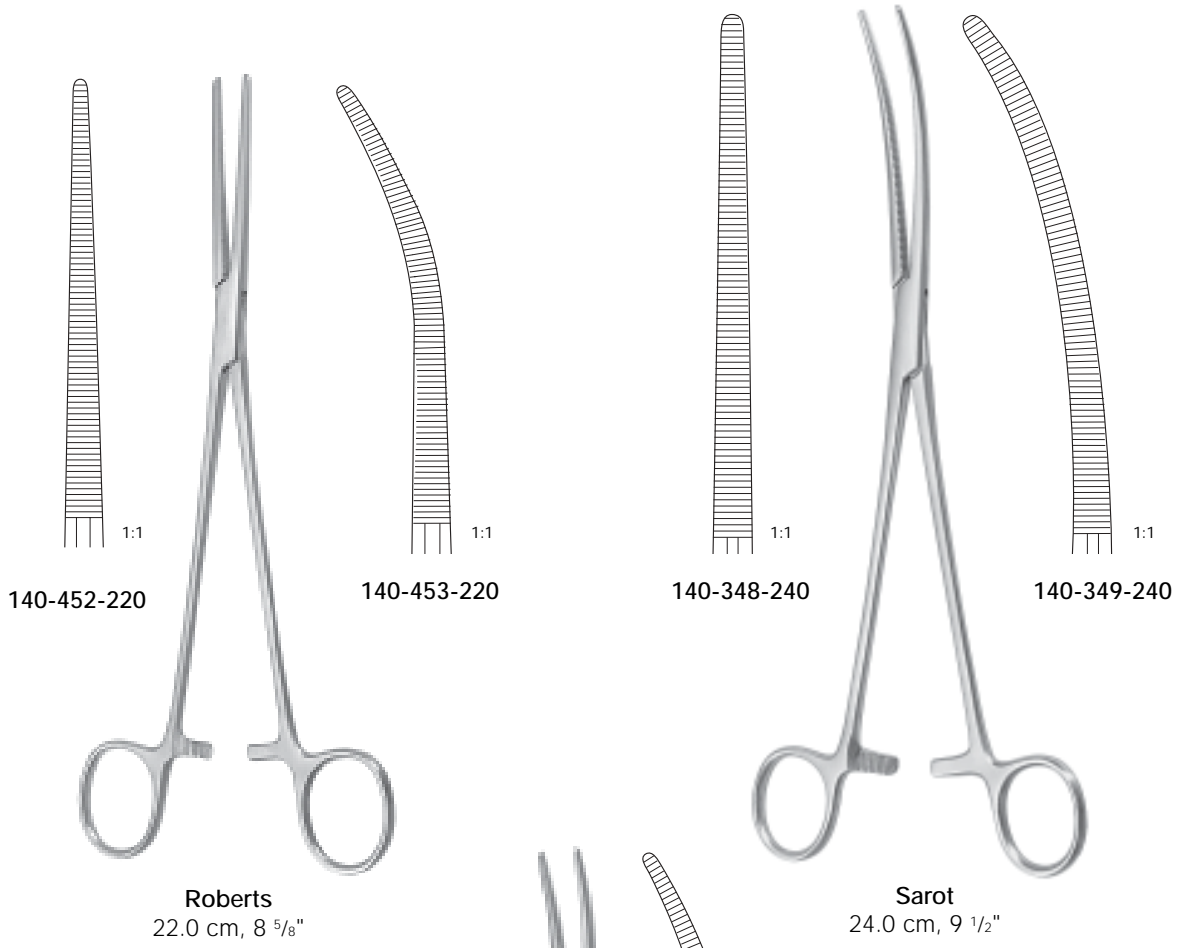

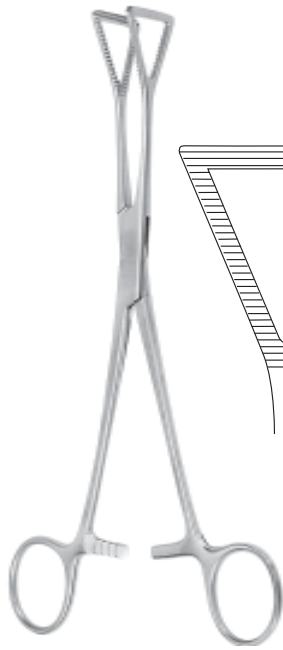

Lovelace  
20.0 cm, 8"  
290-286-200

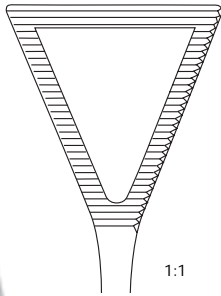

1:1



Lovelace  
20.0 cm, 8"  
290-287-200



Harrington  
30.5 cm, 12"  
290-269-305



Harrington  
29.5 cm, 11 5/8"  
290-271-295

5



Price-Thomas  
22.0 cm, 8 5/8"  
290-241-220

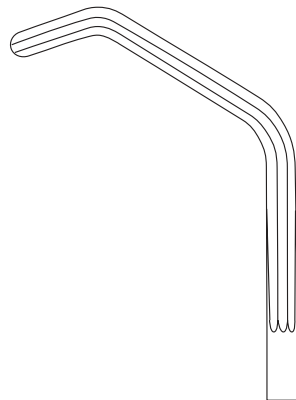

1:1

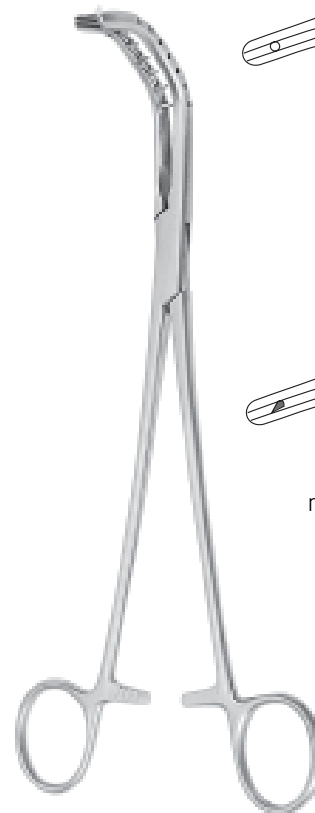

Price-Thomas  
links, left  
22.0 cm, 8 5/8"  
290-245-220

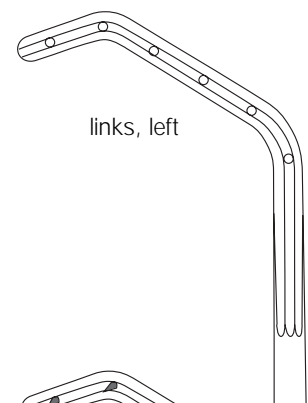

links, left

1:1

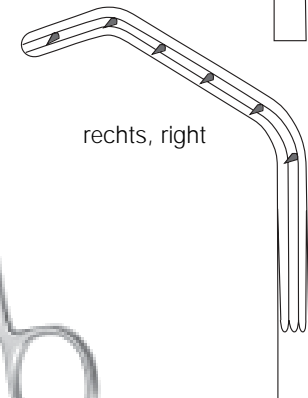

rechts, right

1:1

Price-Thomas  
rechts, right  
22.0 cm, 8 5/8"  
290-247-220

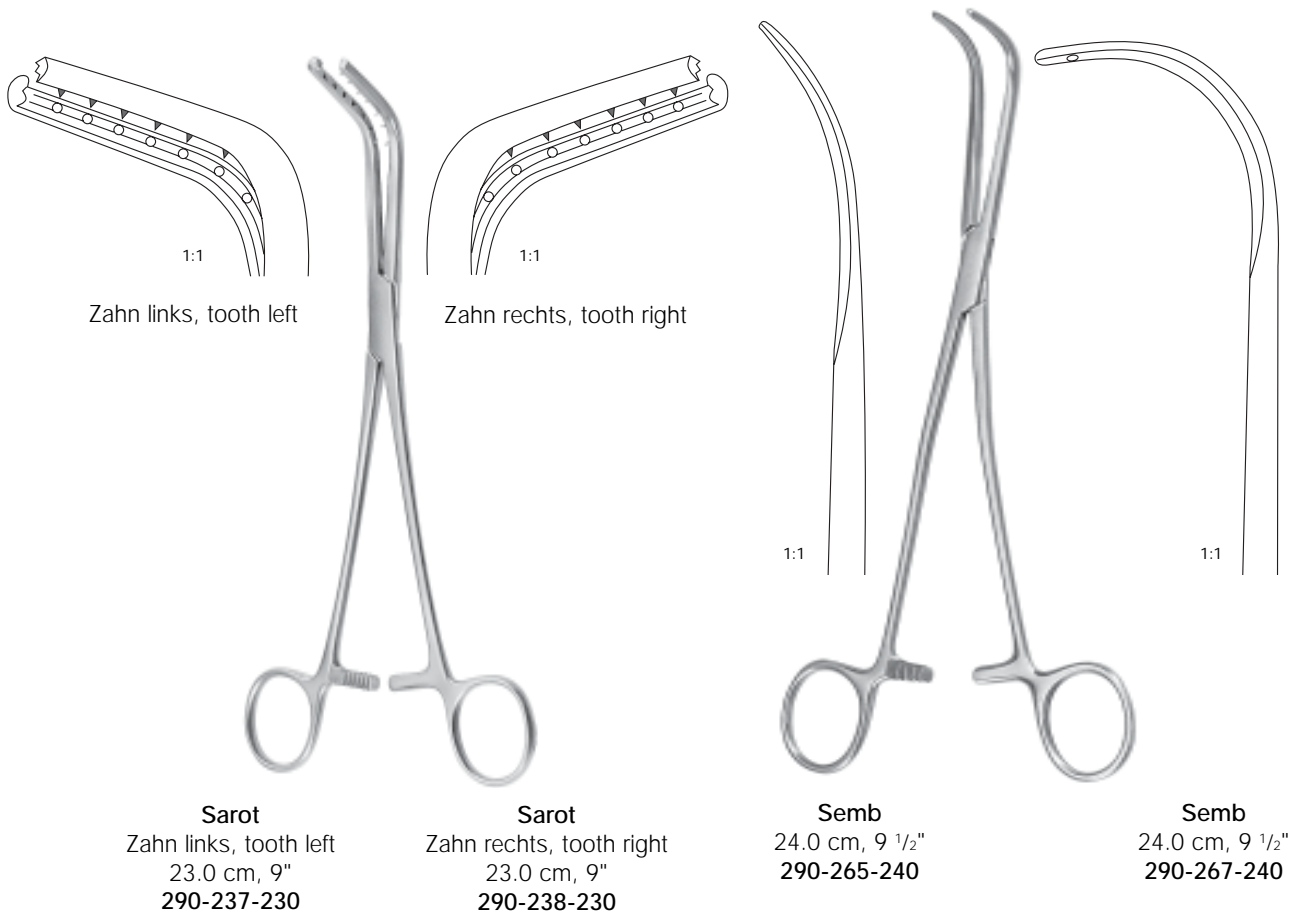

Anastomosens-Klemmen  
Anastomosis Clamps

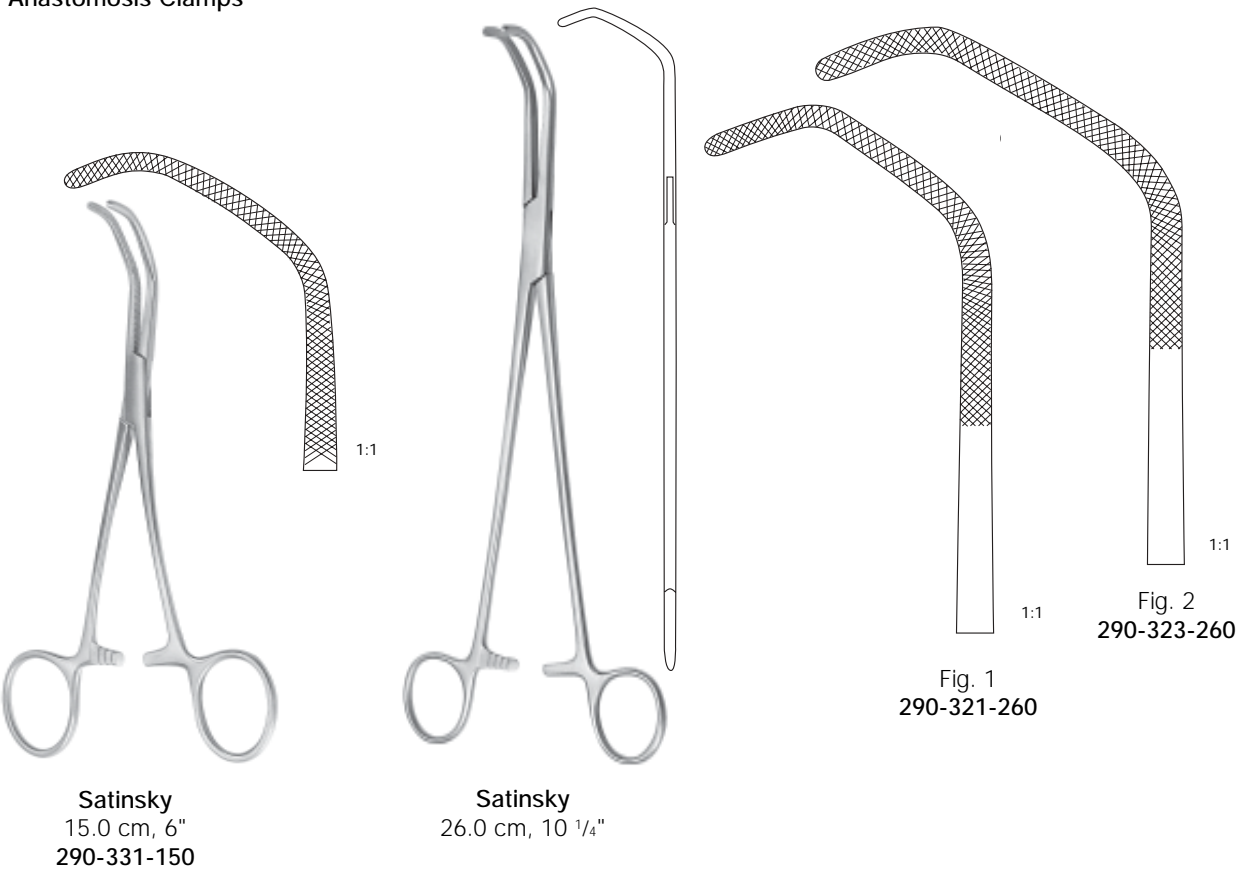



Crafoord-Sellors

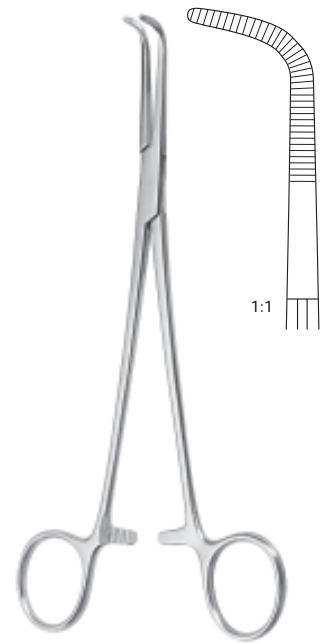
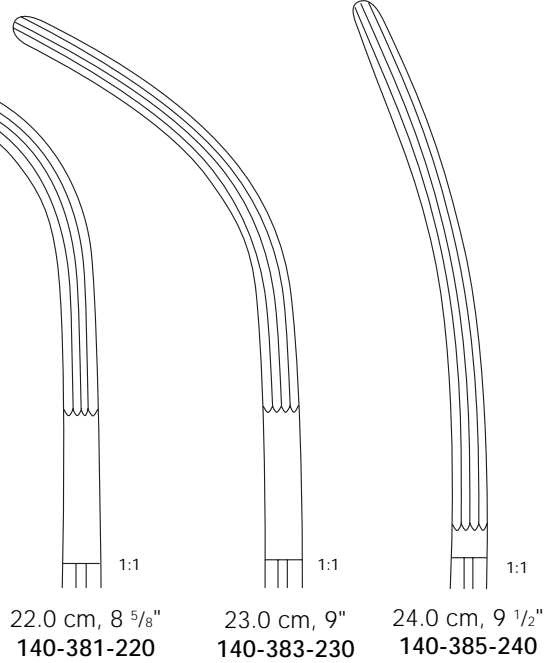

Kantrowitz

19.0 cm, 7 <sup>1</sup> / <sub>2</sub> "	140-417-190
24.0 cm, 9 <sup>1</sup> / <sub>2</sub> "	140-417-240
28.0 cm, 11"	140-417-280

5



Overholt-Geissendoerfer

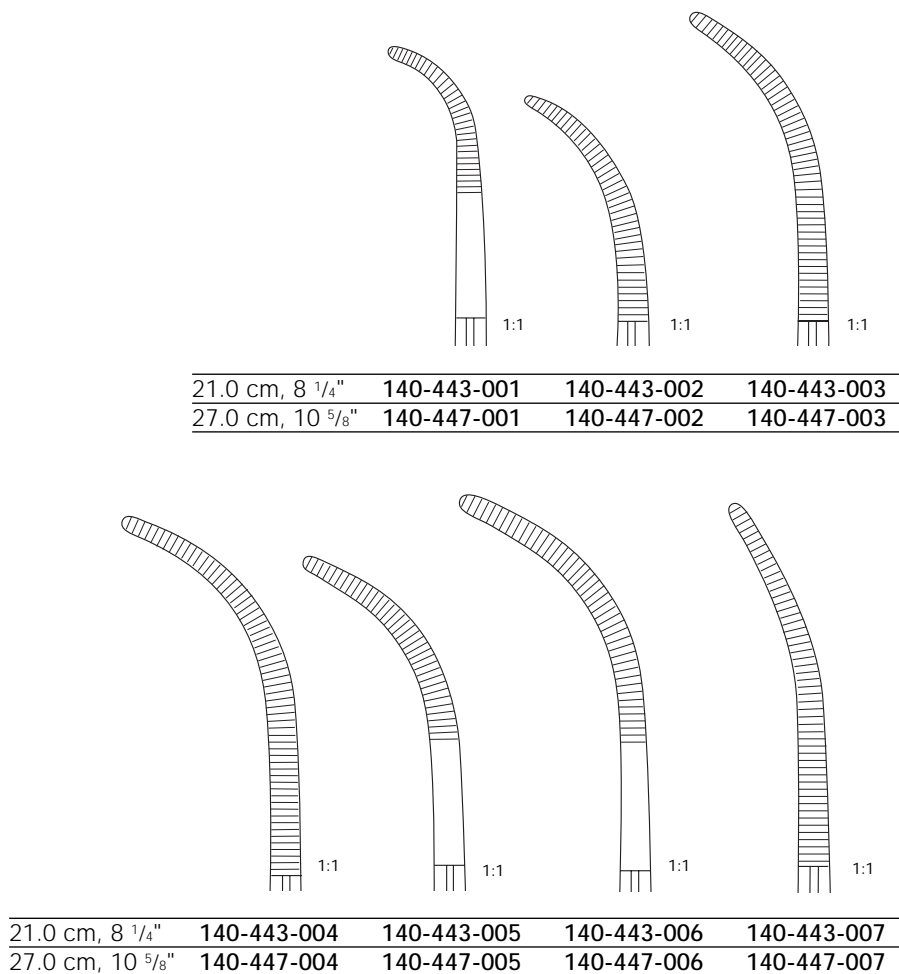





Toennis

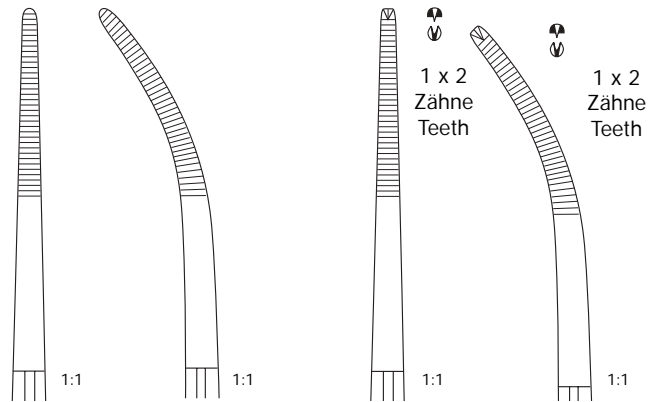

21.0 cm, 8 1/4"	140-412-210	140-413-210	140-414-210	140-415-210
26.0 cm, 10 1/4"	140-412-260	140-413-260	140-414-260	140-415-260

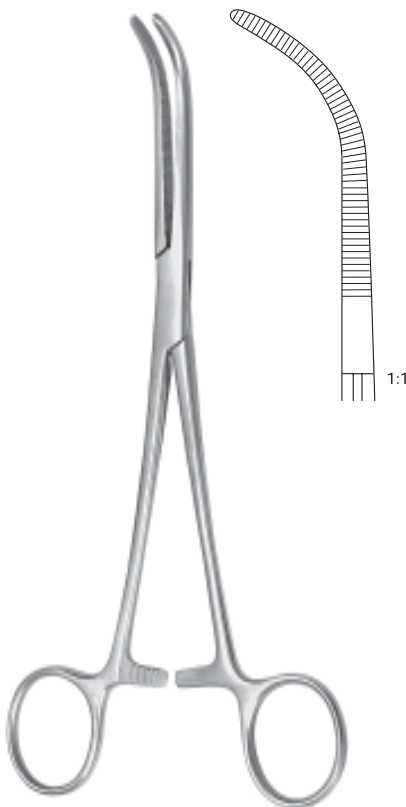

Johns Hopkins  
 20.0 cm, 8"  
 140-410-200

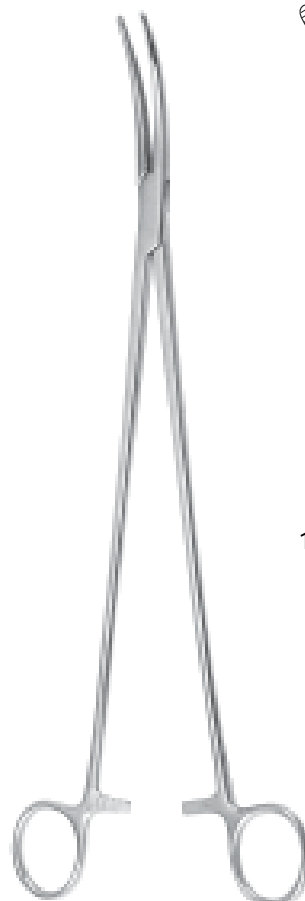

Zenker  
 29.5 cm, 11 5/8"

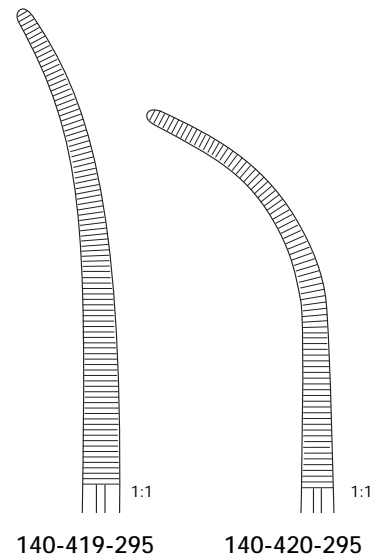



Mini-Gemini

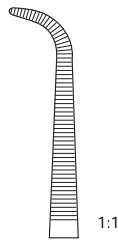

13.0 cm, 5"	140-359-130
16.0 cm, 6 1/4"	140-359-160
18.0 cm, 7"	140-359-180
20.0 cm, 8"	140-359-200
22.0 cm, 8 5/8"	140-359-220
23.0 cm, 9"	140-359-230
25.0 cm, 9 3/4"	140-359-250
28.0 cm, 11"	140-359-280

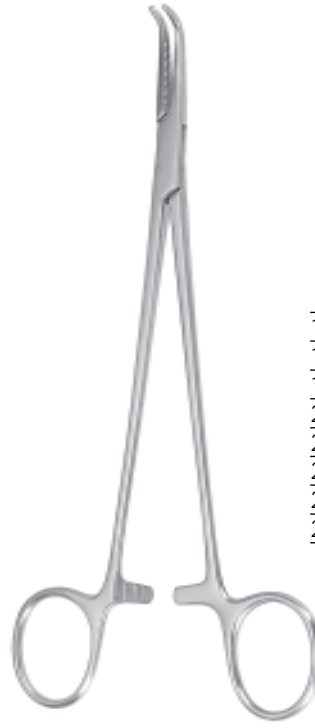

Gemini

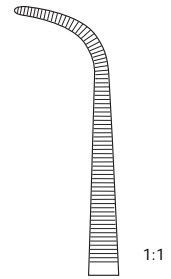

13.0 cm, 5"	140-361-130
16.0 cm, 6 1/4"	140-361-160
18.0 cm, 7"	140-361-180
20.0 cm, 8"	140-361-200
22.0 cm, 8 5/8"	140-361-220
23.0 cm, 9"	140-361-230
25.0 cm, 9 3/4"	140-361-250
28.0 cm, 11"	140-361-280

5



Rumel  
23.0 cm, 9"

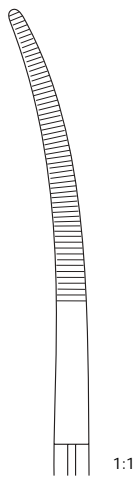

140-346-001

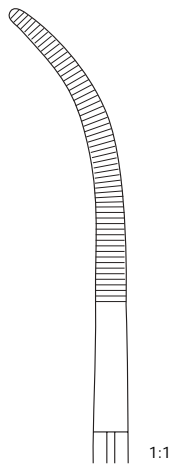

140-346-002

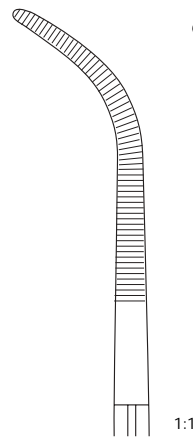

140-346-003

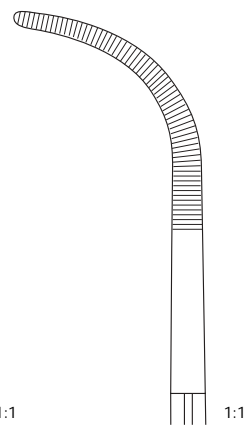

140-346-004



**Mixer Baby**  
14.0 cm, 5 1/2"  
140-421-140



**Mixer**  
15.5 cm, 6"  
140-423-155  
19.0 cm, 7 1/2"  
140-423-190

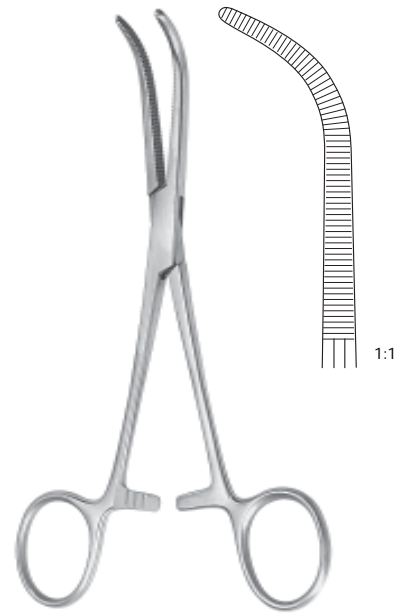

**Mixer-O'Shaughnessy**  
15.5 cm, 6"  
140-425-155  
19.0 cm, 7 1/2"  
140-425-190

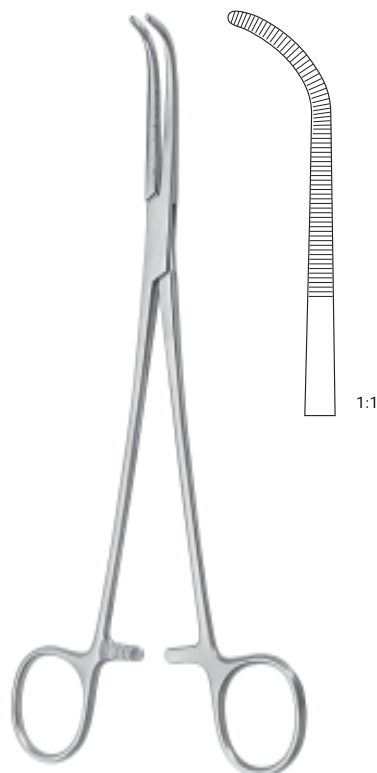

**Mixer**  
22.0 cm, 8 3/4"  
140-427-220



**Mixer**  
23.0 cm, 9"  
140-429-230

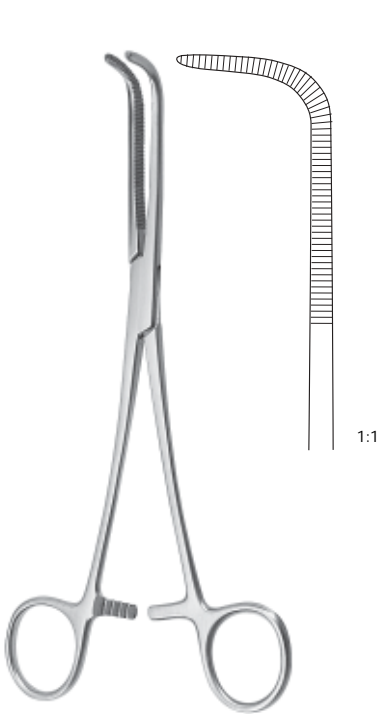

**Wikstroem**  
21.0 cm, 8 1/4"  
140-431-210  
24.0 cm, 9 1/2"  
140-431-240

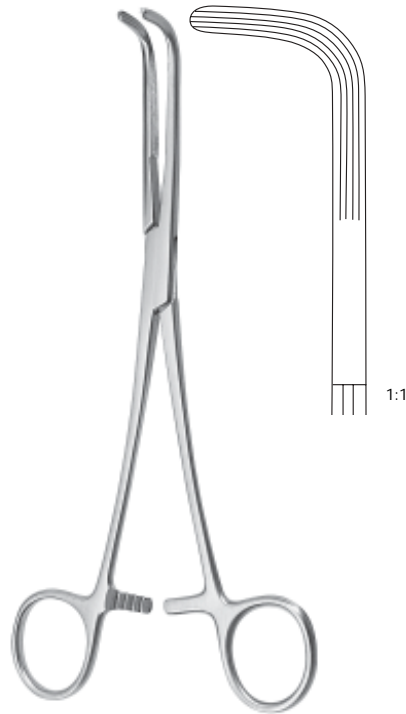

**Mixer**  
22.0 cm, 8 5/8"  
140-433-220  
25.0 cm, 9 3/4"  
140-433-250  
28.0 cm, 11"  
140-433-280

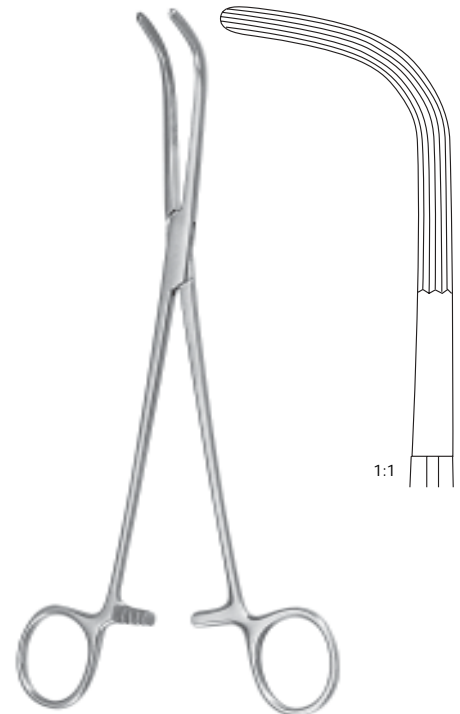

**McQuigg-Mixer**  
22.0 cm, 8 5/8"  
140-435-220

5



**Lower**  
18.0 cm, 7"  
140-437-180

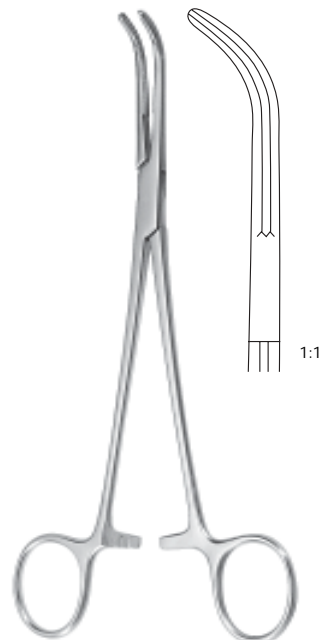

**Lahey**  
19.0 cm, 7 1/2"  
140-439-190  
23.0 cm, 9"  
140-439-230

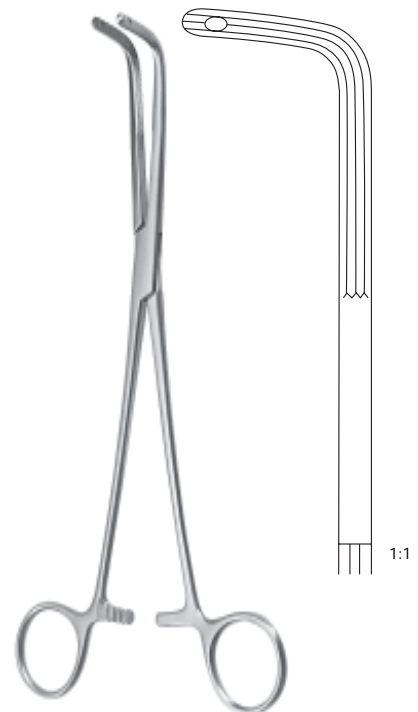

**Finocchietto**  
24.0 cm, 9 1/2"  
140-440-240



Kelly

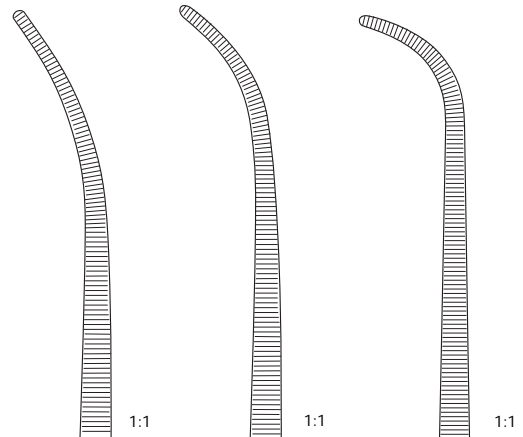

19.0 cm, 7 1/2"	140-633-190	140-635-190	140-637-190
22.0 cm, 8 5/8"	140-633-220	140-635-220	140-637-220
24.0 cm, 9 1/2"	140-633-240	140-635-240	140-637-240

5



Hosemann  
 21.0cm, 8 1/4"

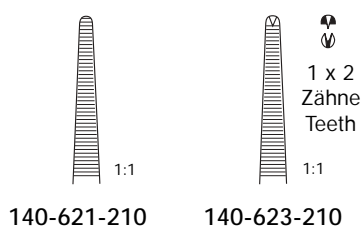

Negus  
 19.0cm, 7 1/2"

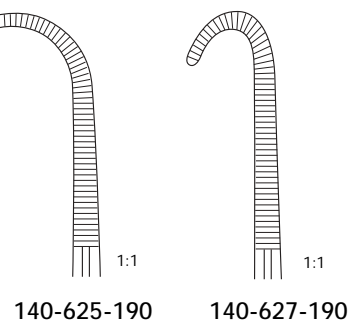

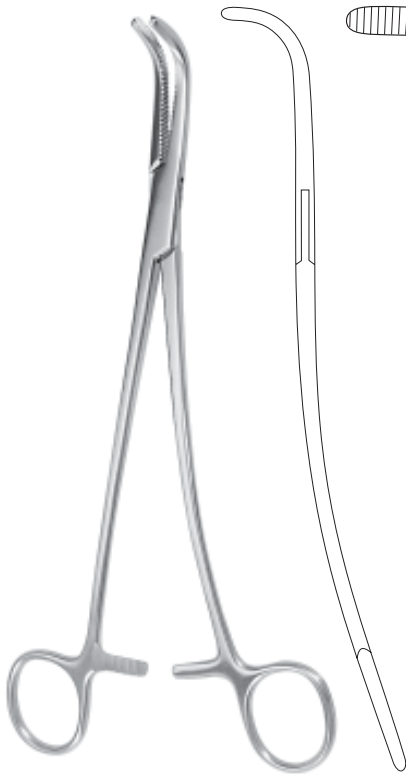

Gray

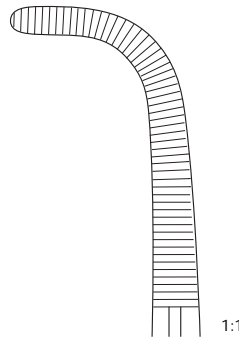

22.0 cm, 8 5/8"  
140-607-220

23.0 cm, 9"  
140-607-230

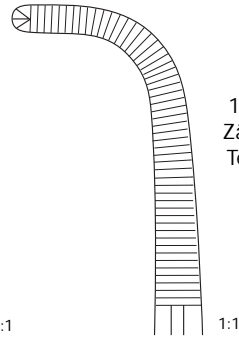

22.0 cm, 8 5/8"  
140-608-220

23.0 cm, 9"  
140-608-230

1 x 2  
Zähne  
Teeth

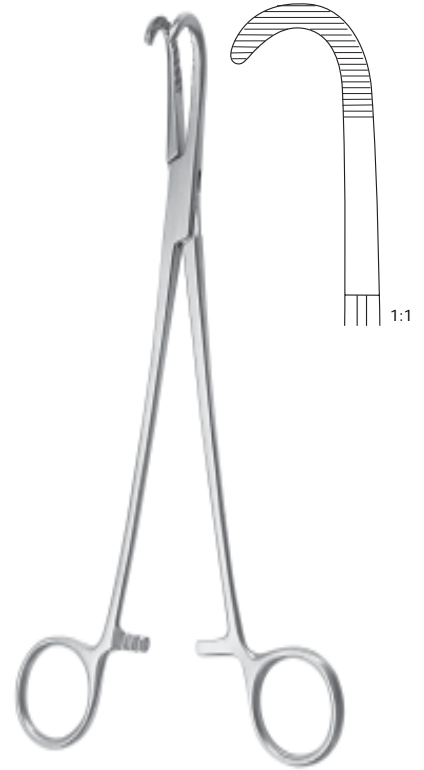

Desjardins  
21.0 cm, 8 1/4"  
140-609-210

5



Lawrence  
27.5 cm, 10 3/4"  
140-617-275

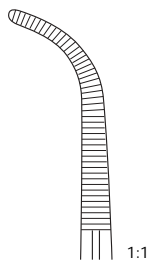

Meeker

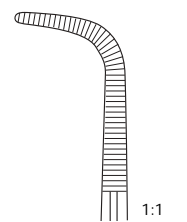

18.0 cm, 7"  
140-619-180

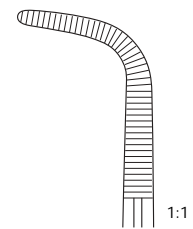

27.5 cm, 10 3/4"  
140-619-275



Uro-Tangential  
26.0 cm, 10 1/4"

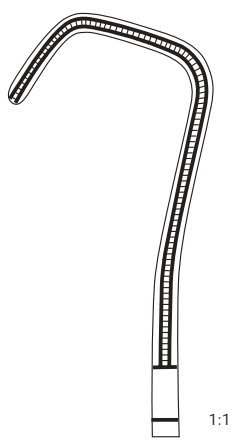

Fig. 1  
140-500-001

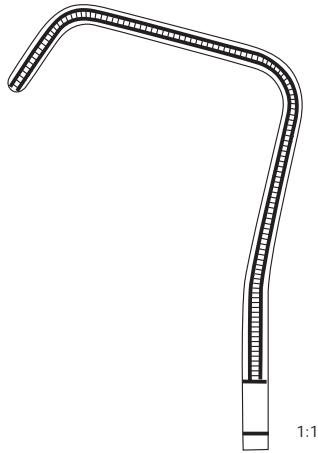
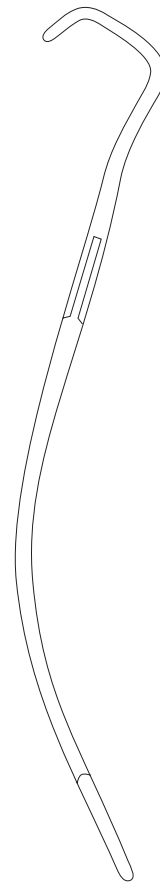
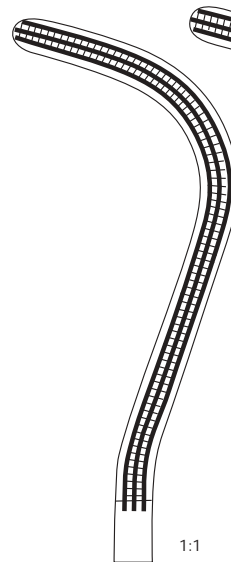

Fig. 2  
140-500-002



Guyon



23.0 cm, 9"  
140-498-230

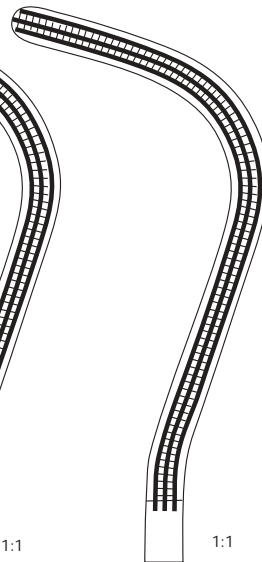

24.0 cm, 9 1/2"  
140-498-240

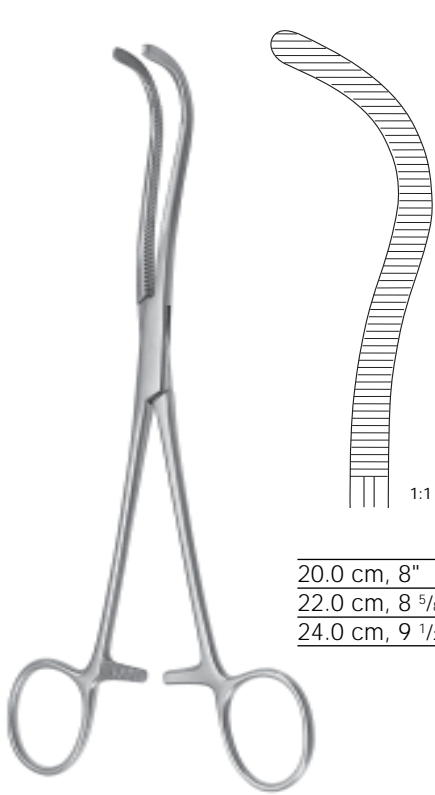

20.0 cm, 8"	140-600-200
22.0 cm, 8 5/8"	140-600-220
24.0 cm, 9 1/2"	140-600-240

Guyon

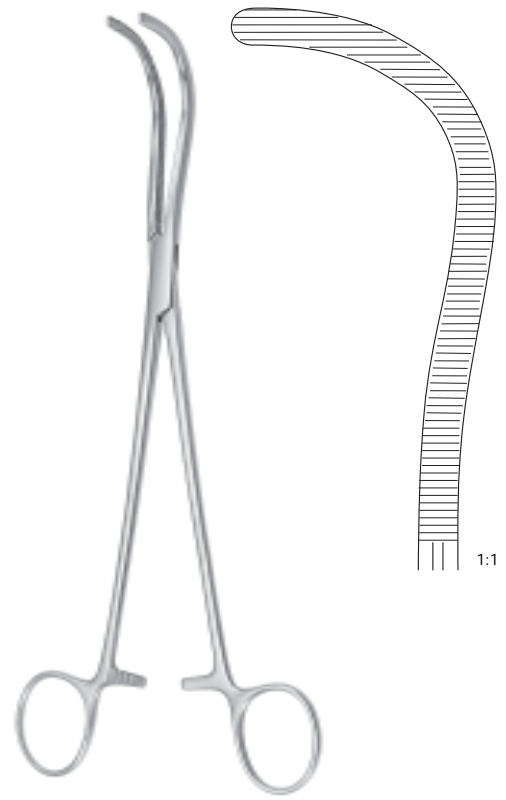

Guyon  
23.0 cm, 9"  
140-603-230

5

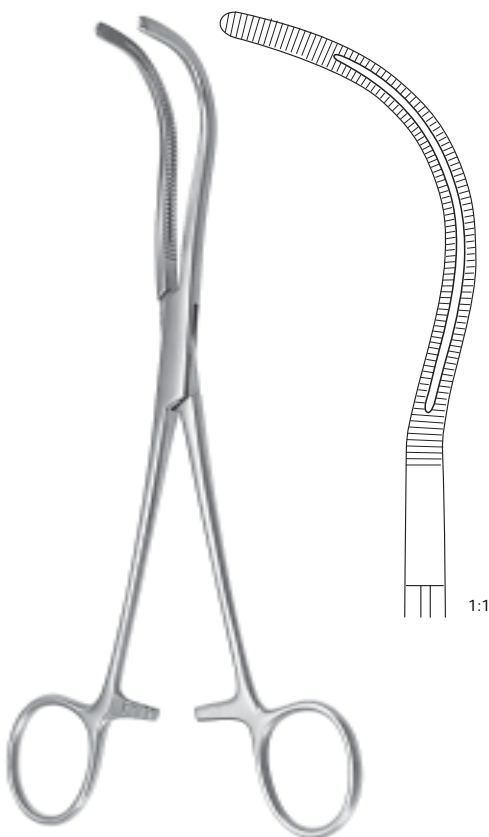

Stille  
23.0 cm, 9"  
140-602-230

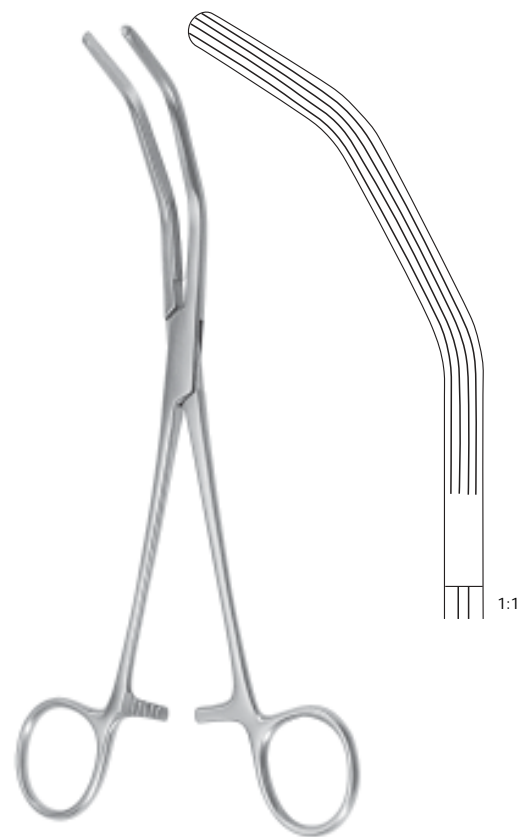

Herrick  
23.0 cm, 9"  
140-604-230



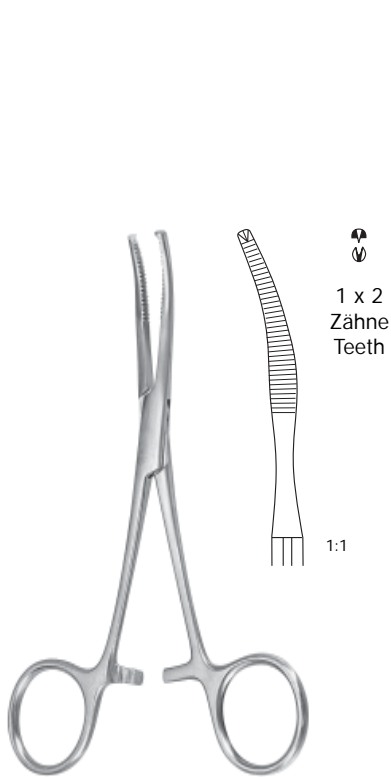

**Baby-Mikulicz**  
14.0 cm, 5 1/2"  
140-547-140

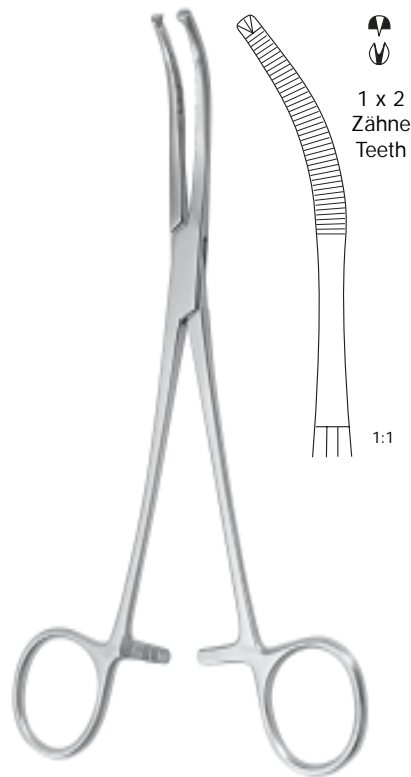

**Mikulicz**  
20.0 cm, 8"  
140-549-200

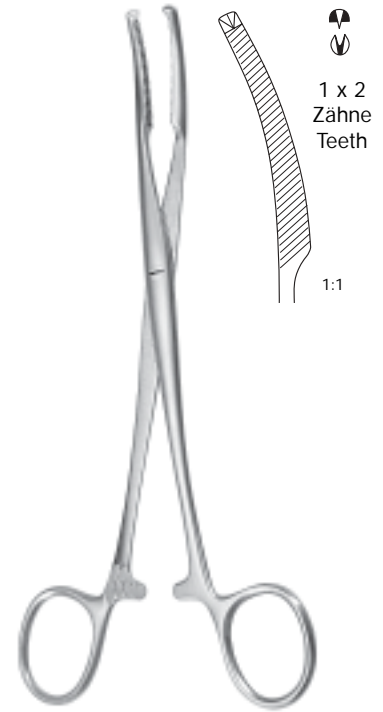

**Mikulicz**  
18.0 cm, 7"  
140-548-180

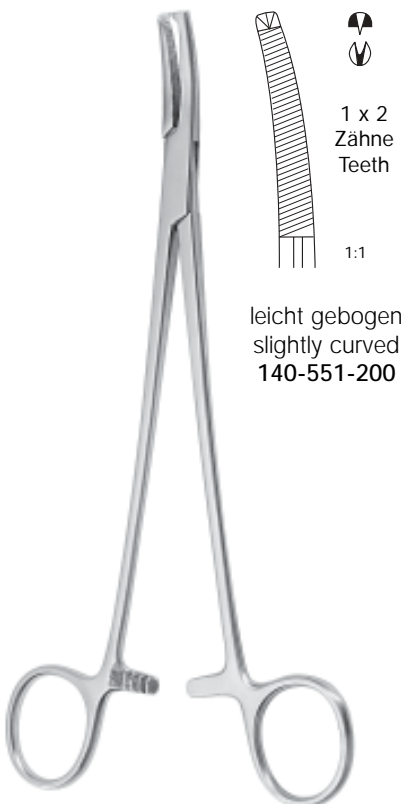

**Faure**  
20.0 cm, 8"

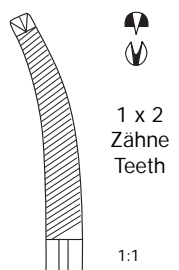

leicht gebogen  
slightly curved  
140-551-200

stärker gebogen  
stronger curved  
140-553-200

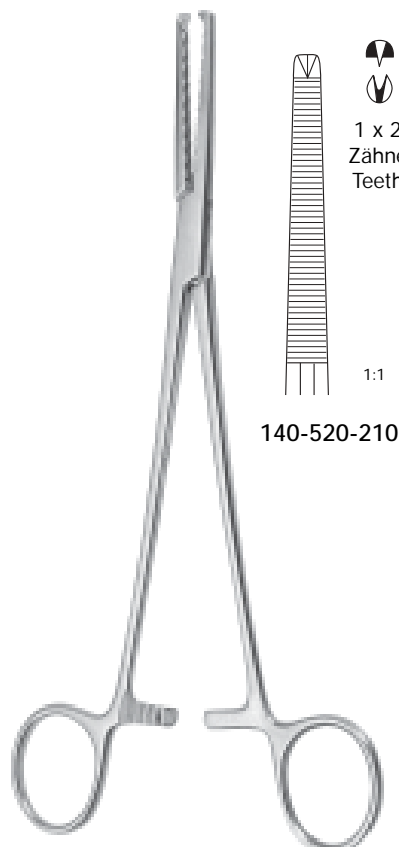

**Phaneuf**  
21.5 cm, 8 1/2"

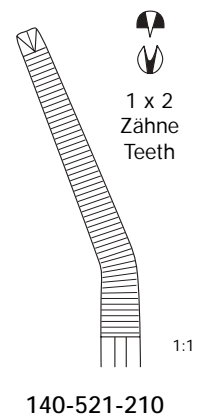



5

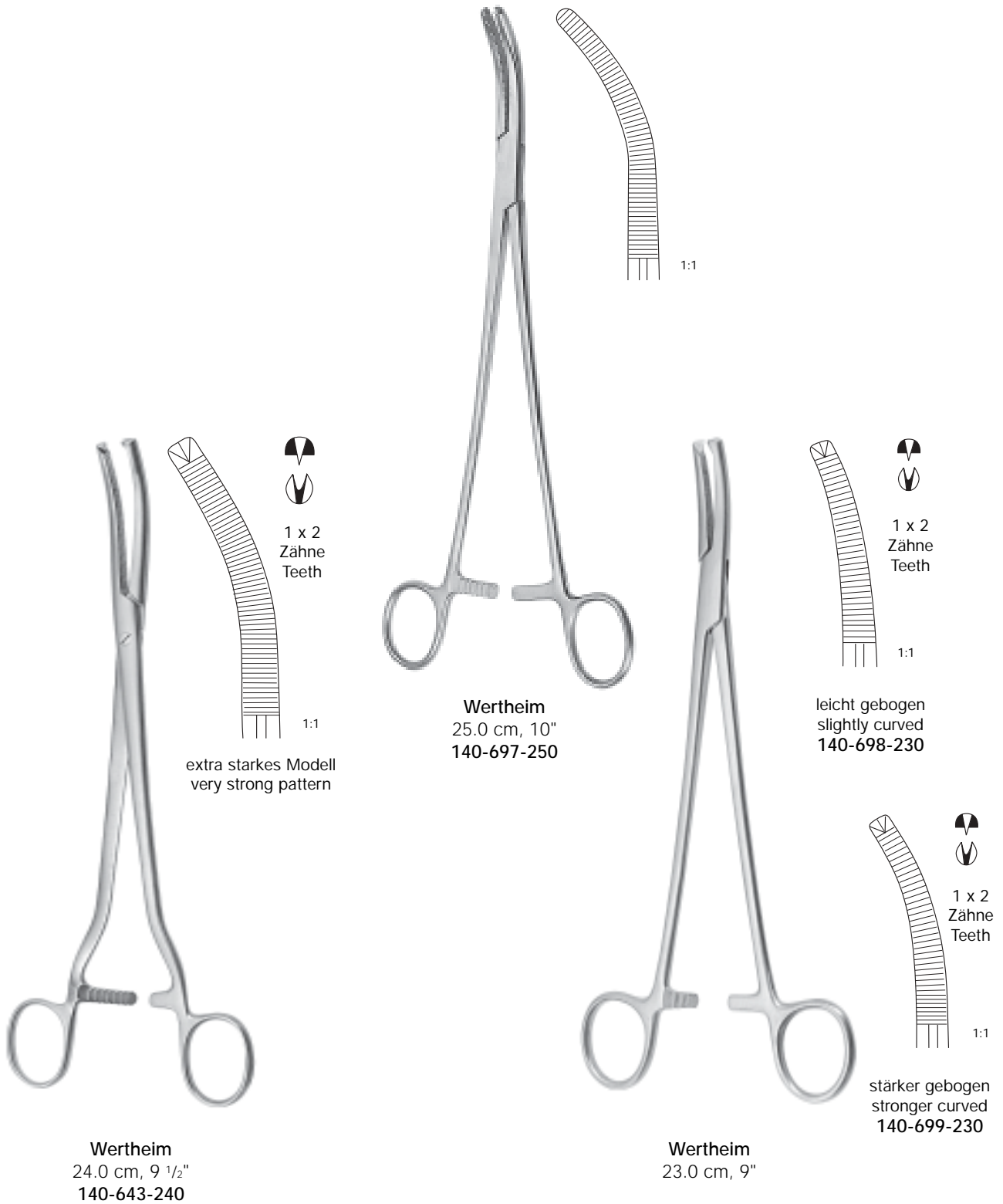

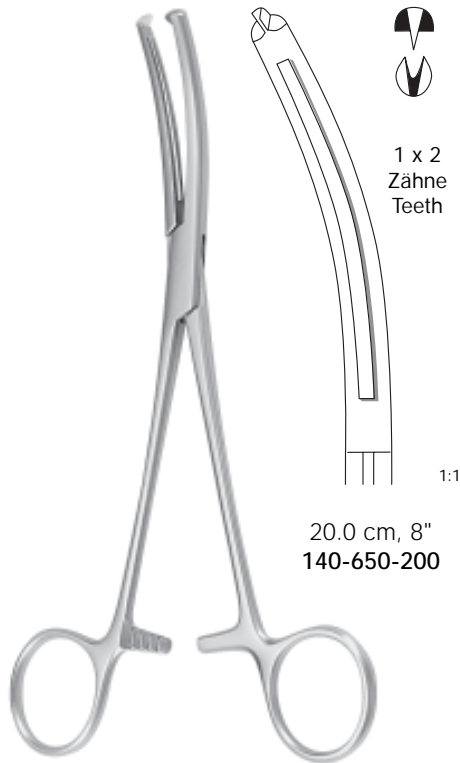

1 x 2  
Zähne  
Teeth

20.0 cm, 8"  
140-650-200

Maingot

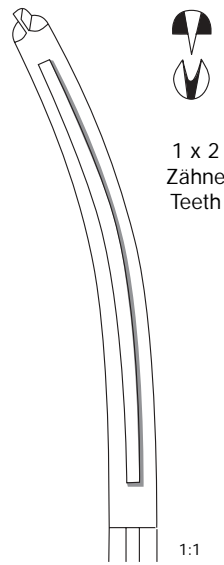

1 x 2  
Zähne  
Teeth

25.0 cm, 10"  
140-650-240

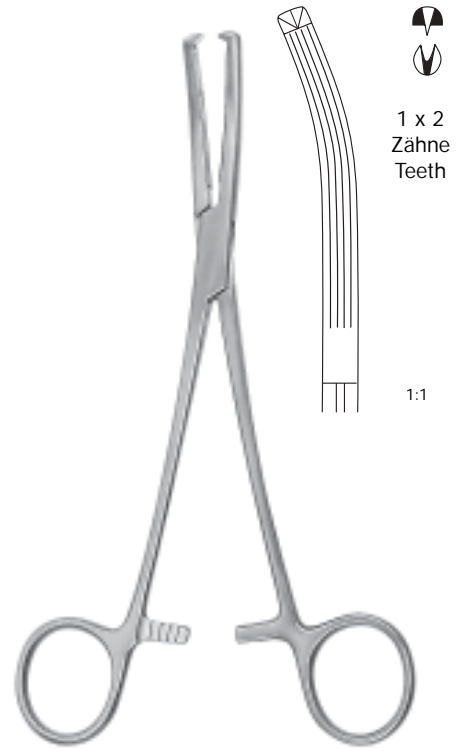

1 x 2  
Zähne  
Teeth

Long  
19.0 cm, 7 1/4"  
140-652-190

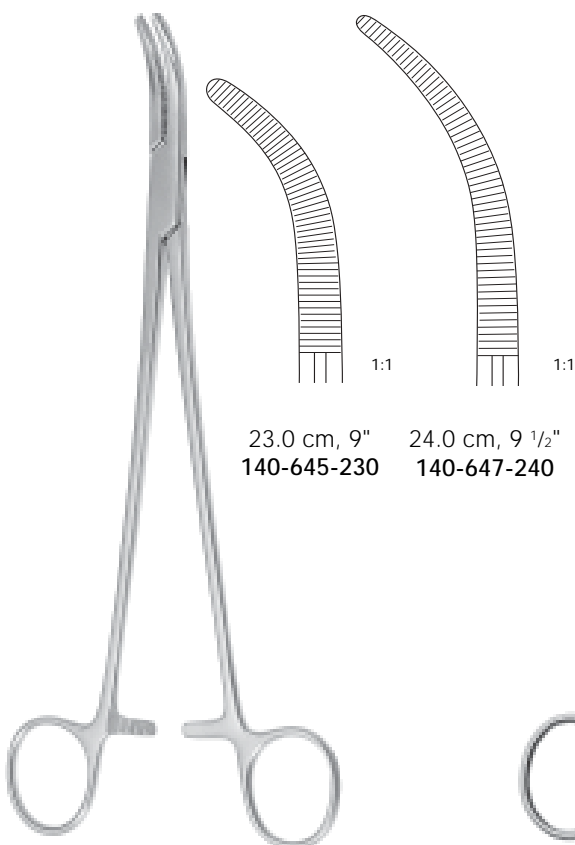

23.0 cm, 9"  
140-645-230

24.0 cm, 9 1/2"  
140-647-240

Moynihan

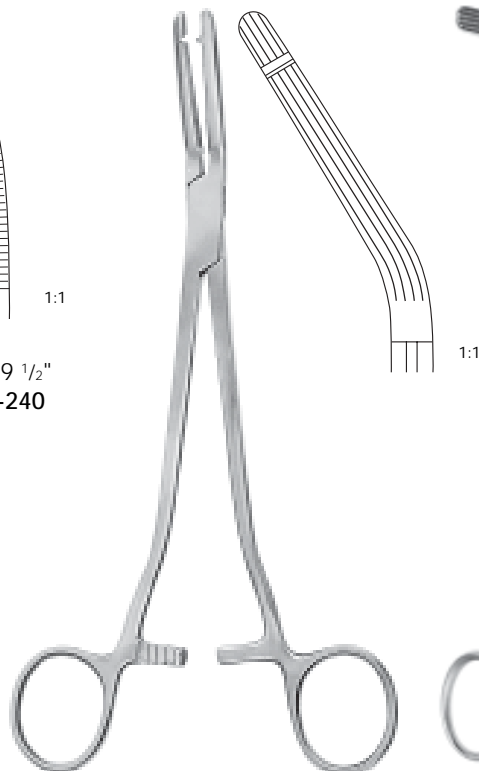

Garland  
21.0 cm, 8 1/4"  
140-639-210

Garland

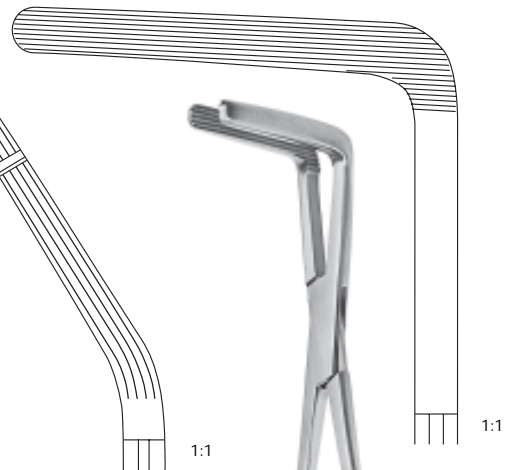

Wertheim-Cullen  
21.5 cm, 8 1/2"  
140-641-215

Wertheim-Cullen



leichtes Maul  
light jaw

21.0 cm, 8 1/4"	140-613-210	140-615-210
23.0 cm, 9"	140-613-230	140-615-230

Heaney  
21.0 cm, 8 1/4"  
140-612-210

Heaney

5



21.0 cm, 8 1/4"  
140-617-210

Heaney-Ballantine

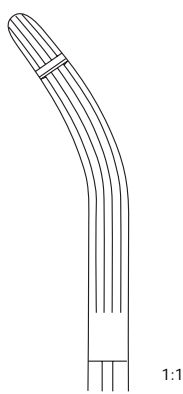

21.0 cm, 8 1/4"  
140-618-210

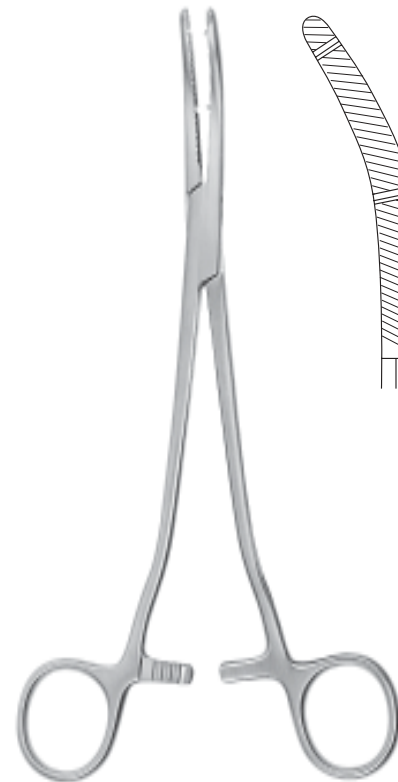

Heaney-Kanter  
21.0 cm, 8 1/4"  
140-619-210



**Presbyterian**  
16.5 cm, 6 1/2"  
140-601-165  
18.0 cm, 7"  
140-601-180  
20.0 cm, 8"  
140-601-200

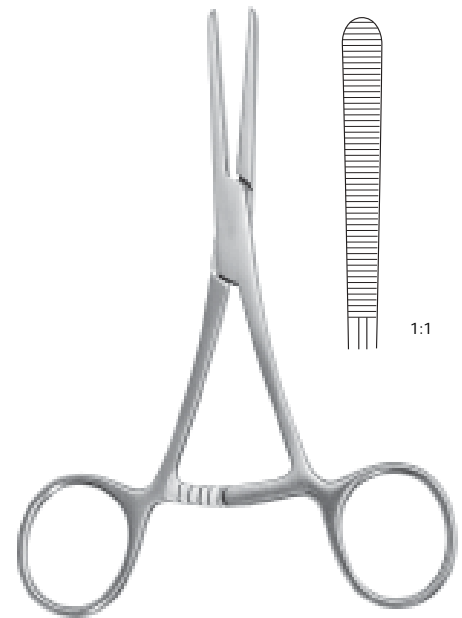

mit langer Sperre  
with long ratchet  
14.5 cm, 5 3/4"  
140-600-145

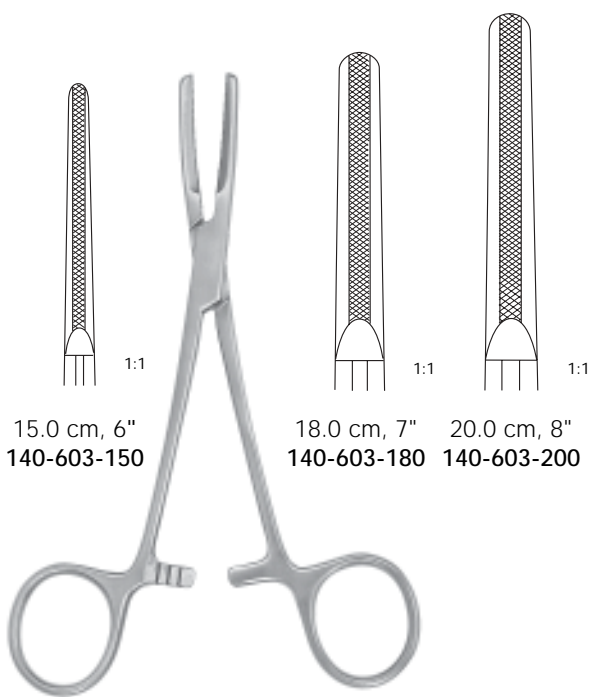

15.0 cm, 6"  
140-603-150  
18.0 cm, 7"  
140-603-180  
20.0 cm, 8"  
140-603-200

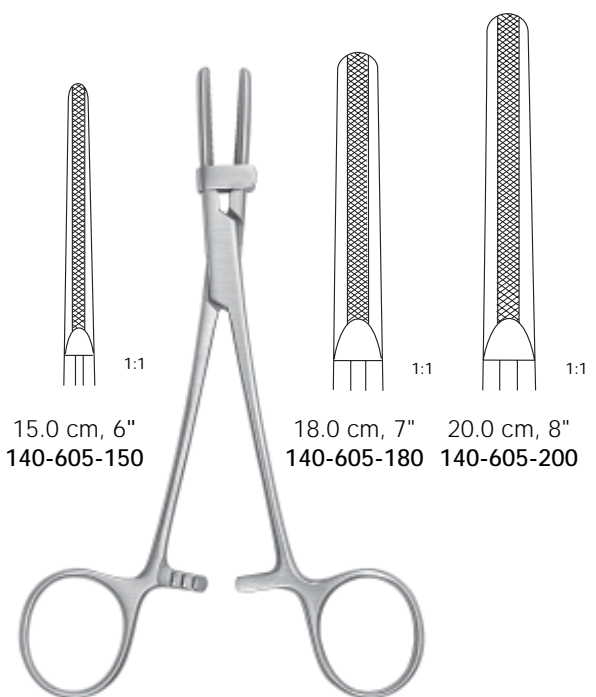

15.0 cm, 6"  
140-605-150  
18.0 cm, 7"  
140-605-180  
20.0 cm, 8"  
140-605-200



**Schaedel**  
9.0 cm, 3 1/2"  
140-559-090



**Engl. Modell**  
9.0 cm, 3 1/2"  
140-560-090



**Jones**  
5.0 cm, 2"  
140-561-050  
9.0 cm, 3 1/2"  
140-561-090



**Jones-Clip**  
9.0 cm, 3 1/2"  
140-562-090

Mit Schlauch- bzw.  
Kabelhalter  
With clip for tubing  
or cable fixation

5



**Backhaus**

8.0 cm, 3 1/8"	140-573-080
9.0 cm, 3 1/2"	140-573-090
11.0 cm, 4 3/8"	140-573-110
13.0 cm, 5"	140-573-130
15.0 cm, 6"	140-573-150



Mit Schlauch- bzw.  
Kabelhalter  
With clip for tubing  
or cable fixation

11.0 cm, 4 3/8"  
140-575-110



**Roeder**  
13.0 cm, 5"  
140-579-130  
15.0 cm, 6"  
140-579-150

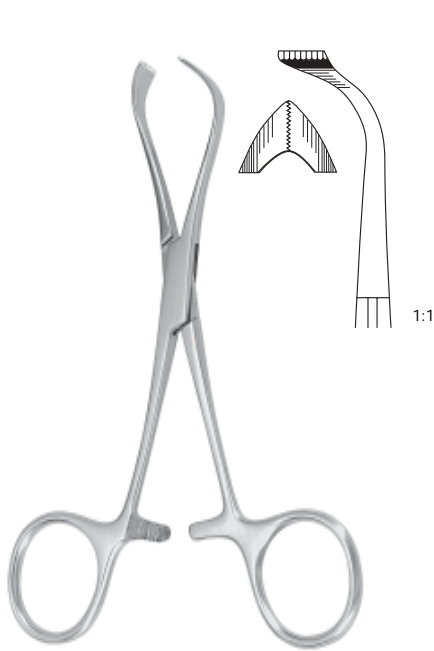

**Lorna**  
10.0 cm, 4"  
140-578-100  
13.0 cm, 5"  
140-578-130



**Lane**  
15.0 cm, 6"    140-585-150  
18.0 cm, 7"    140-585-180  
20.0 cm, 8"    140-585-200

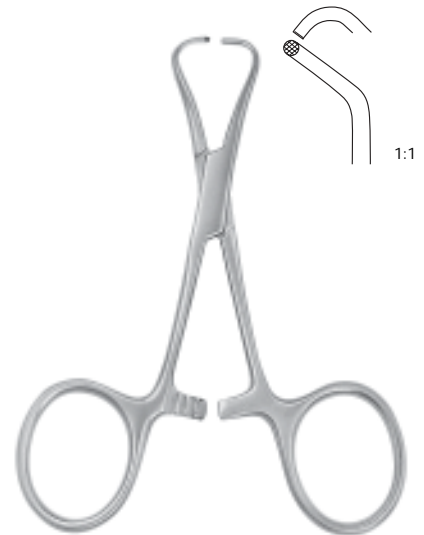

**Tohoku-Japan**  
10.0 cm, 4"  
140-590-100  
13.0 cm, 5"  
140-590-130



**Ball and Socket**  
13.0 cm, 5"  
140-580-130

für Papiertücher  
for paper tissues

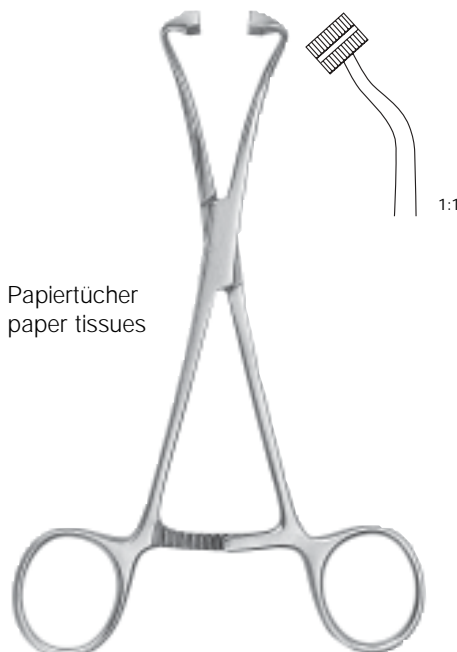

**Peers**  
14.5 cm, 5 3/4"  
140-595-145



**Bernhard**  
16.5 cm, 6 1/2"  
140-579-165



Ulrich

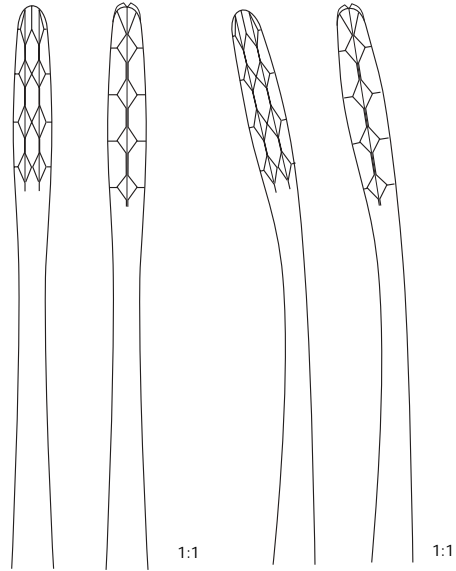

22.0 cm, 8 5/8"	150-010-220	150-011-220
25.0 cm, 9 3/4"	150-010-250	150-011-250
27.0 cm, 10 5/8"	150-010-270	150-011-270

6



Gross-Maier

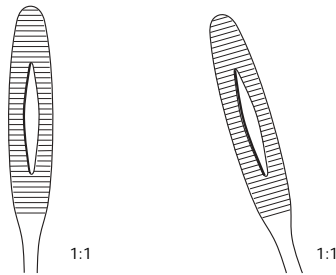

20.0 cm, 8"	150-030-200	150-031-200
22.0 cm, 8 5/8"	150-030-220	150-031-220
25.0 cm, 9 3/4"	150-030-250	150-031-250
27.0 cm, 10 5/8"	150-030-270	150-031-270





**Collin**  
25.0 cm, 9 3/4"  
150-038-250



**Cheron**  
25.0 cm, 9 3/4"  
150-290-250

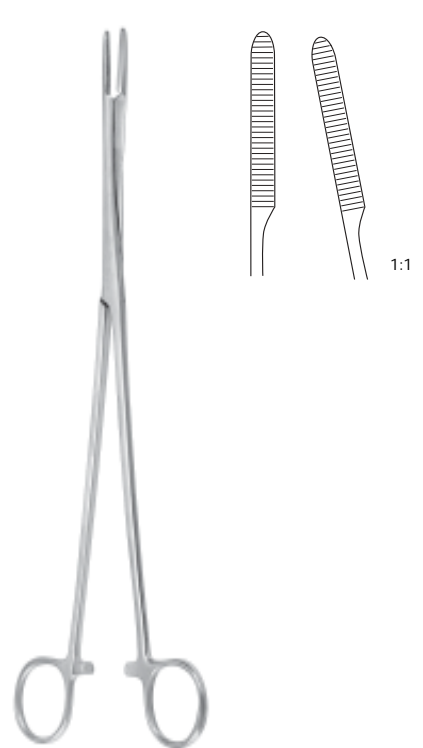

**Pelkmann**  
25.0 cm, 9 3/4"  
150-045-250

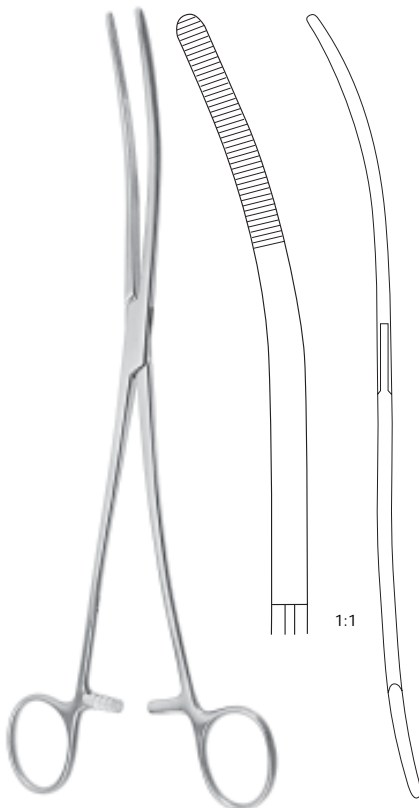

**Bozemann**  
26.0 cm, 10 1/4"  
150-041-260

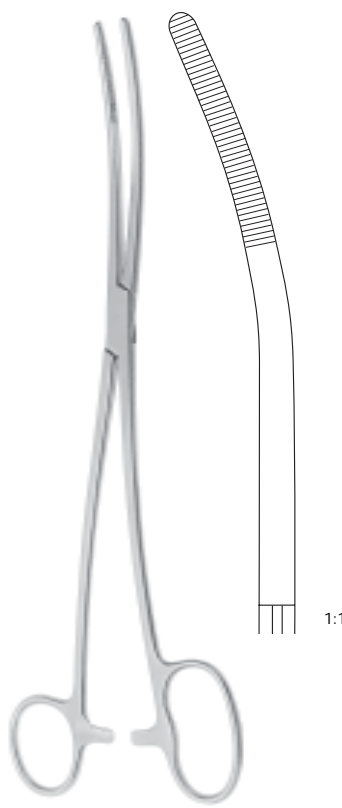

**Bozemann-Douglas**  
26.0 cm, 10 1/4"  
150-043-260

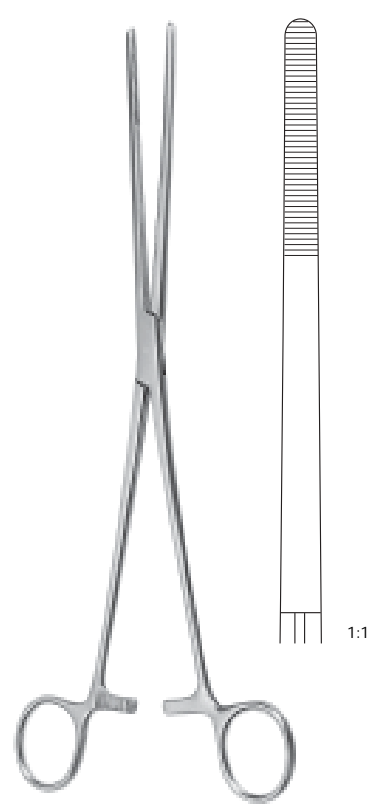

**Bozemann**  
26.0 cm, 10 1/4"  
150-040-260

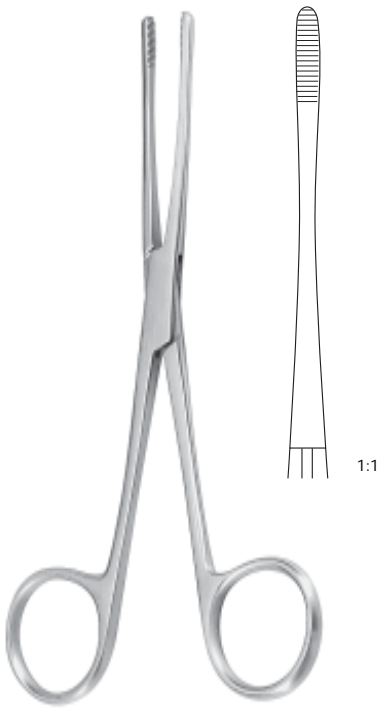

Lister

13.0 cm, 5"	150-080-130
16.0 cm, 6 1/4"	150-080-160
18.0 cm, 7"	150-080-180

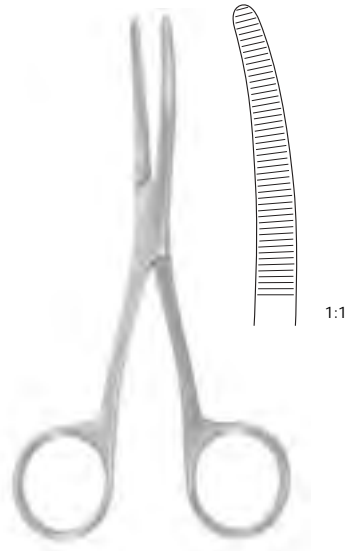

Bryant

13.0 cm, 5"  
150-035-130

6



Foerster

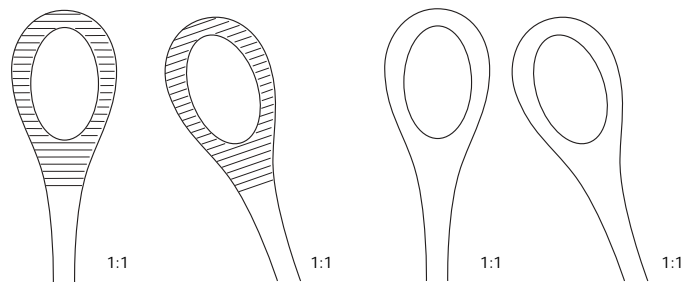

18.0 cm, 7"	150-052-180	150-055-180	150-050-180	150-053-180
20.0 cm, 8"	150-052-200	150-055-200	150-050-200	150-053-200
25.0 cm, 9 3/4"	150-052-250	150-055-250	150-050-250	150-053-250



Foerster

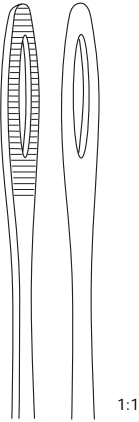

25.0 cm, 9 3/4"  
150-060-250

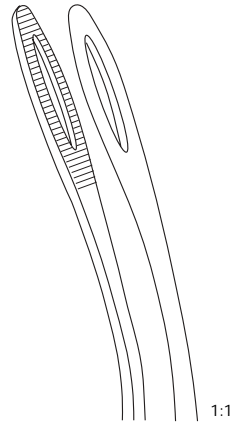

25.0 cm, 9 3/4"  
150-061-250



Rampley  
18.0 cm, 7"  
150-070-180

25.0 cm, 9 3/4"  
150-070-250

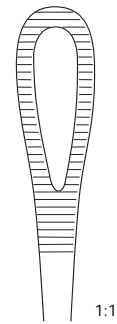

1:1

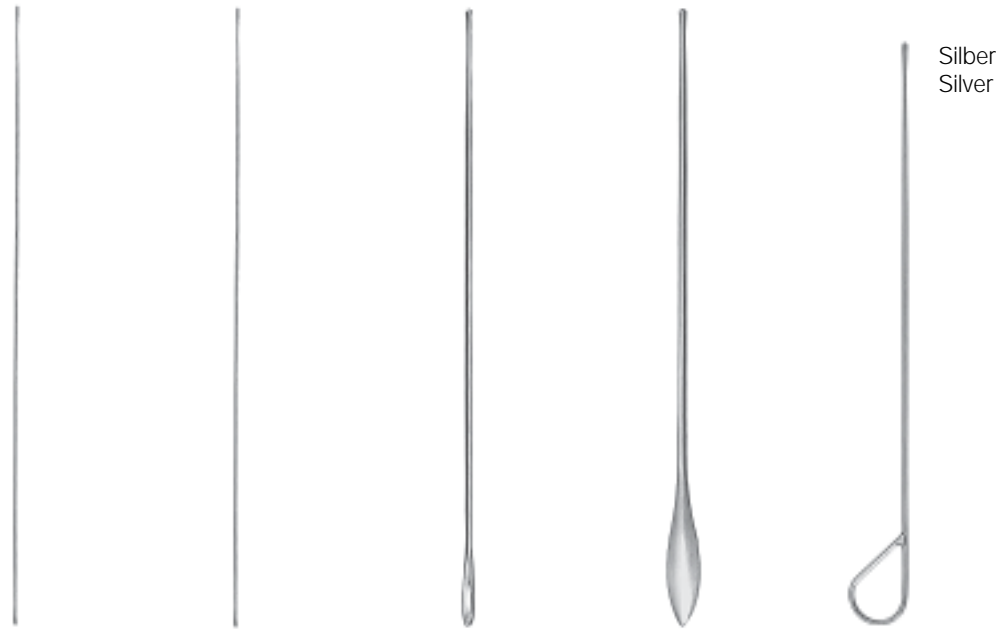

ø 1.0 mm

ø 2.0 mm

mit Ohr, with eye  
ø 2.0 mm

Myrtenblatt  
Myrtle Leaf

Stacke  
ø 1.0 mm

10.5 cm, 4 1/8"				
11.5 cm, 4 1/2"	160-102-115	160-100-115	160-108-115	
13.0 cm, 5"	160-102-130	160-100-130	160-108-130	
14.5 cm, 5 3/4"	160-102-145	160-100-145	160-108-145	160-150-145
16.0 cm, 6 1/4"	160-102-160	160-100-160	160-108-160	160-150-160
18.0 cm, 7"	160-102-180	160-100-180	160-108-180	160-150-180
20.0 cm, 8"	160-102-200	160-100-200	160-108-200	160-150-200



Doyen

Nélaton

11.5 cm, 4 1/2"	160-107-115			
13.0 cm, 5"	160-107-130		160-170-130	
14.5 cm, 5 3/4"	160-107-145	160-175-145	160-170-145	
16.0 cm, 6 1/4"	160-107-160		160-170-160	160-185-160
18.0 cm, 7"	160-107-180		160-170-180	
20.0 cm, 8"	160-107-200			



**Brodie**  
20.0 cm, 8"  
160-090-200

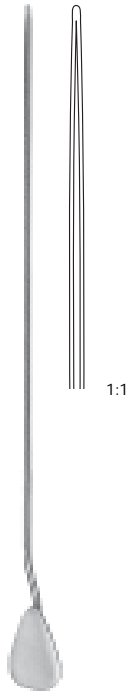

**Lockhart-Mummery**  
Fig. 1  
160-110-001



**Lockhart-Mummery**  
Fig. 2  
160-110-002

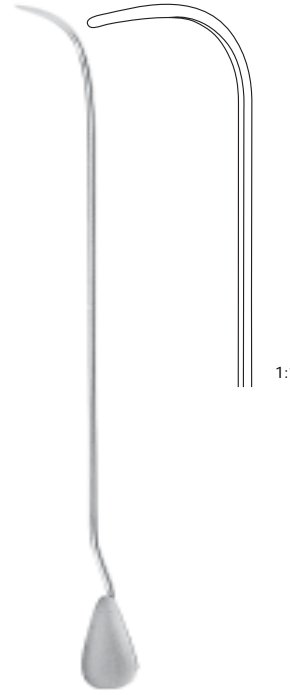

**Lockhart-Mummery**  
Fig. 3  
160-110-003

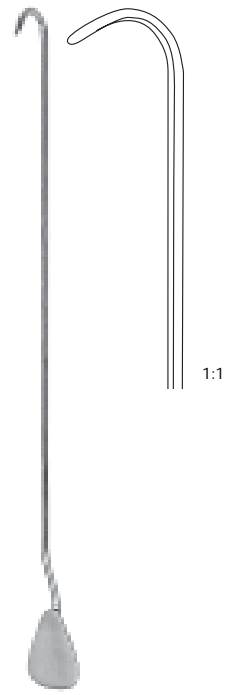

**Lockhart-Mummery**  
Fig. 4  
160-110-004



Zinn, biegsam  
tin, malleable  
ø 3.5 mm  
25.0 cm, 9 3/4"  
160-415-250

30.0 cm, 11 3/4"  
160-415-300



**Farrell (Lathbury-Uebe)**  
ø 0.9 mm  
12.0 cm, 4 3/4"  
160-420-120

ø 0.9 mm  
14.0 cm, 5 1/2"  
160-420-140

ø 1.1 mm  
16.5 cm, 6 1/2"  
160-420-165

ø 1.2 mm  
18.0 cm, 7"  
160-420-180



**Farrell**  
ø 0.9 mm  
12.0 cm, 4 3/4"  
160-426-120

ø 0.9 mm  
14.0 cm, 5 1/2"  
160-426-140

ø 1.1 mm  
16.5 cm, 6 1/2"  
160-426-165

ø 1.2 mm  
18.0 cm, 7"  
160-426-180

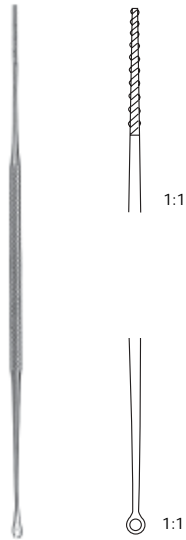

**Uckermann**  
16.0 cm, 6 1/4"  
160-254-160



**Jobson-Horne**  
18.0 cm, 7"  
160-255-180



**Fein**  
28.0 cm, 11"  
160-495-280



3.0 mm  
160-250-003



6.0 mm  
160-250-006

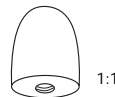

9.0 mm  
160-250-009

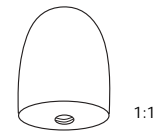

12.0 mm  
160-250-012

7

Handgriff alleine  
Handle, only  
160-250-080

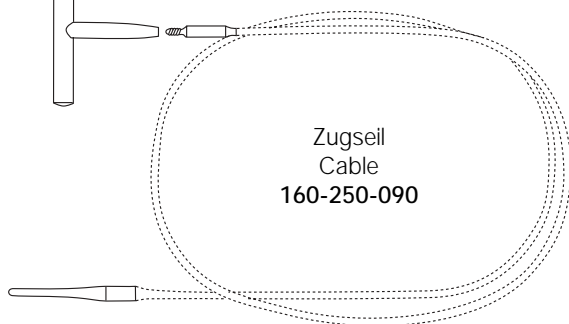

Zugseil  
Cable  
160-250-090

Metalletui  
Metal case  
135 x 100 x 25 mm  
160-250-095



**Nabatoff**  
komplett, complete  
160-250-000

Kunststoff-Sondenspitze  
probe tip, plastic  
160-250-002



Standard  
11.0 cm, 4 3/8"

ø 3.0 mm	165-020-003
ø 3.5 mm	165-020-035
ø 4.0 mm	165-020-004
ø 4.5 mm	165-020-045
ø 5.0 mm	165-020-005
ø 5.5 mm	165-020-055
ø 6.0 mm	165-020-006



Standard  
12.0 cm, 4 3/4"

ø 3.0 mm	165-022-003
ø 3.5 mm	165-022-035
ø 4.0 mm	165-022-004
ø 4.5 mm	165-022-045
ø 5.0 mm	165-022-005
ø 5.5 mm	165-022-055
ø 6.0 mm	165-022-006



Standard  
12.0 cm, 4 3/4"

ø 3.0 mm	165-024-003
ø 3.5 mm	165-024-035
ø 4.0 mm	165-024-004
ø 4.5 mm	165-024-045
ø 5.0 mm	165-024-005
ø 5.5 mm	165-024-055
ø 6.0 mm	165-024-006



Universal  
Satz zu 3 Stück  
Set of 3 pieces  
165-001-003  
  
Satz zu 4 Stück  
Set of 4 pieces  
165-001-004

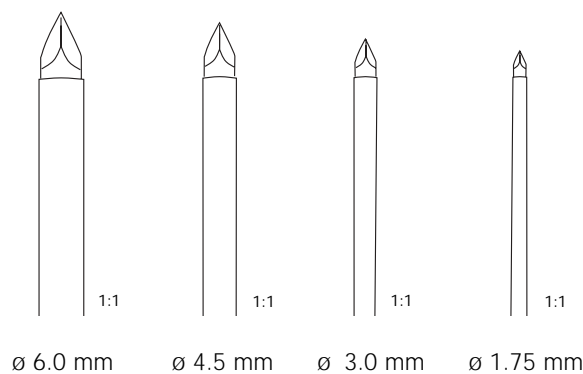

Universal  
Satz zu 3 Stück  
Set of 3 pieces  
165-002-003  
  
Satz zu 4 Stück  
Set of 4 pieces  
165-002-004



Landau  
ø 2.0 mm  
165-025-001



Landau  
ø 2.0 mm  
165-025-002



Davidson  
ø 6.0 mm  
165-035-006



Lermoyez  
ø 2.0 mm 165-035-002  
ø 2.5 mm 165-035-025  
ø 3.0 mm 165-035-003



Buelau  
24.0 cm, 9 1/2"  
ø 8.0 mm  
165-030-240



Hurwitz  
ø 7.3 mm 165-031-007  
ø 8.7 mm 165-031-009  
ø 12.0 mm 165-031-012

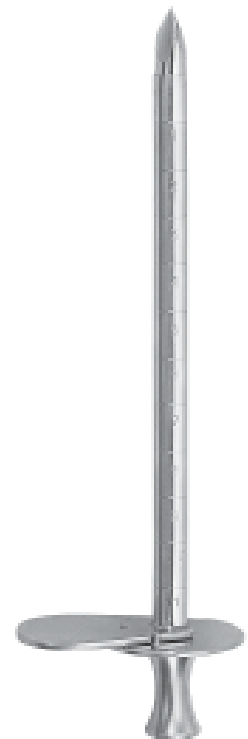

Campbell  
ø 6.0 mm  
165-033-006  
ø 8.0 mm  
165-033-008



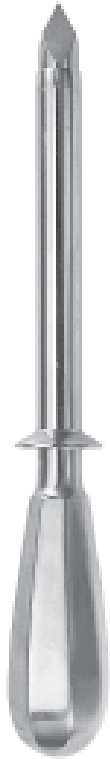

**Nelson**  
21.0 cm, 8 1/2"

ø 7.5 mm	<b>165-010-007</b>
ø 9.0 mm	<b>165-010-009</b>
ø 10.5 mm	<b>165-010-011</b>
ø 12.0 mm	<b>165-010-012</b>



**Ochsner**  
14.0 cm, 5 1/2"

ø 4.0 mm	<b>165-034-004</b>
ø 4.6 mm	<b>165-034-045</b>
ø 5.5 mm	<b>165-034-055</b>
ø 6.5 mm	<b>165-034-065</b>



**Krause**  
ø 5.5 mm  
**165-056-055**



**Coakley**  
ø 2.25 mm  
**165-058-225**



**Lichtwitz**  
ø 1.8 mm  
**165-052-018**



**Douglas**  
Trokarkanüle  
Trocar Cannula  
ø 3.0 mm  
**165-061-110**



Kieferhöhlentrocars  
Antrum Puncture Trocar  
11.0 cm, 4 1/2"  
**165-062-110**



**Pierce**  
ø 3.0 mm **165-054-003**  
ø 4.0 mm **165-054-004**  
ø 5.0 mm **165-054-005**

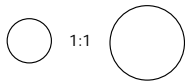

<b>Poole</b>	
22.0 cm, 8 5/8"	
∅ 6.0 mm	165-549-220
∅ 10.0 mm	165-550-220

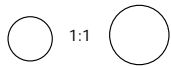

<b>Poole</b>	
22.0 cm, 8 5/8"	
∅ 6.0 mm	165-552-220
∅ 8.0 mm	165-551-220



**Coupland**  
17.0 cm, 6 3/4"  
165-558-000



**Yankauer**  
27.0 cm, 10 5/8"  
165-543-270



**DeBakey**  
27.0 cm, 10 5/8"  
165-065-270



**Andrews-Pynchon**  
24.0 cm, 9 1/2"  
165-066-000



**Anthony**  
26.0cm, 10 1/4"  
165-064-000



**Cooley**  
35.0 cm, 13 3/4"  
ø 8.0 mm  
165-552-350



**Cooley**  
30.0 cm, 11 3/4"  
ø 7.0 mm  
165-552-300



**Cooley**  
31.0 cm, 11 3/4"  
ø 10.0 mm  
165-552-310

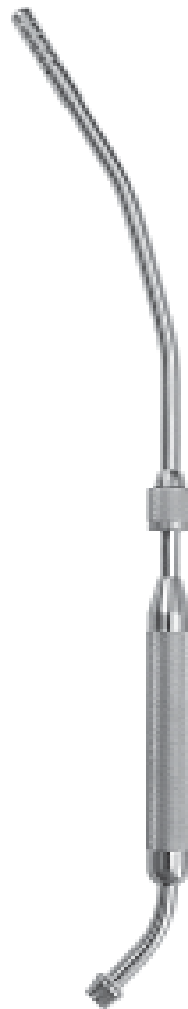

**Cooley**  
33.0 cm, 13"  
ø 8.0 mm  
165-552-330



Olive allein  
Olive only  
165-543-000



- $\varnothing$  1.5 mm  
165-560-001
- $\varnothing$  2.5 mm  
165-560-002
- $\varnothing$  3.5 mm  
165-560-003

**Byrd**  
20.0 cm, 8"



**Cogswell**  
23.0 cm, 9"  
 $\varnothing$  2.0 mm  
165-562-230



**Hepp/Scheidel**  
22.5 cm, 8 3/4"  
165-546-225



**Adson**  
21.0 cm, 8 1/4"  
 $\varnothing$  4 mm  
165-521-004



**Magill**  
17.5cm, 6 5/8"

$\varnothing$ 1.0 mm	410-404-010
$\varnothing$ 2.0 mm	410-404-020
$\varnothing$ 3.0 mm	410-404-030
$\varnothing$ 4.0 mm	410-404-040



$\varnothing$ mm	Charr./ Fr.	19.0 cm, 7 1/2"
2.0	6.0	165-523-006
2.5	8.0	165-523-008
3.0	10.0	165-523-010
4.0	12.0	165-523-012



**Fergusson**  
18.0cm, 7"



**Poppen**  
13.0 cm, 5"

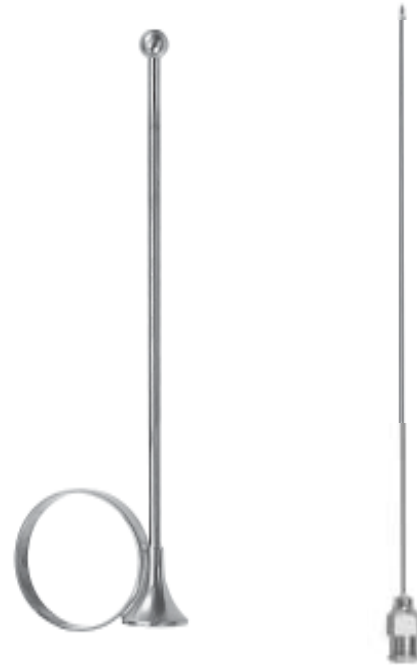

**Luer-Lock**

**Injektionskanülen, Hypodermic Needles**

Fig. 1	ø 0,90 x 38 mm, 20 G x 1 1/2"	<b>165-690-001</b>
Fig. 2	ø 0,80 x 32 mm, 21 G x 1 1/4"	<b>165-690-002</b>
Fig. 12	ø 0,70 x 32 mm, 22 G x 1 1/4"	<b>165-690-012</b>
Fig. 14	ø 0,65 x 28 mm, 23 G x 1 1/8"	<b>165-690-014</b>
Fig. 16	ø 0,60 x 25 mm, 22 G x 1"	<b>165-690-016</b>
Fig. 18	ø 0,50 x 23 mm, 25 G x 7/8"	<b>165-690-018</b>
Fig. 20	ø 0,45 x 20 mm, 26 G x 3/4"	<b>165-690-020</b>

**Iowa**  
165-695-000

**Nadel, needle 1.0 x 185 mm**  
165-695-001

Spezialbesteck für die Transvaginale Injektion bei Paracervical- und Pudendusnästhesie inklusive Führungshülse und Nadel

Special Set for transvaginal injection for paracervical anaesthesia as well as anaesthesia of the pudendus incl. guide sheath and needle

Nach Applikation der Führungshülse am Injektionsort wird die Kanüle (mit aufgesetzter Spritze) durch den Trichter bzw. durch die Hülse hindurchgeführt und ins Gewebe eingestochen. Verletzungen der Vagina werden hierbei vermieden, da die Einstichtiefe nur ca 10 mm erreicht.

After introducing the guide sheath at the spot to be injected, the needle (mounted on the syringe) is then passed through the guide sheath and the tissue is injected. Injuries of the vagina are thus avoided, because the depth of puncture is limited to approximately 10 mm.

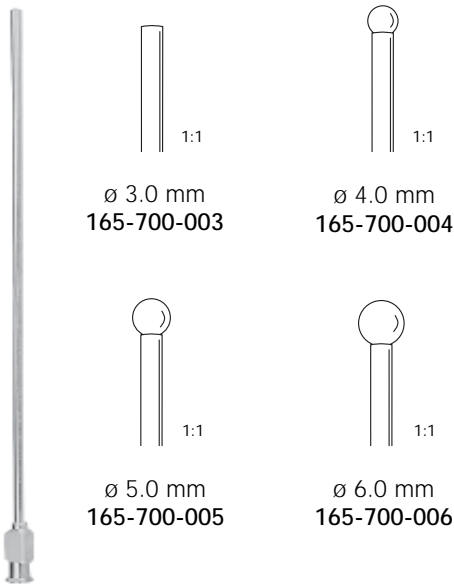

ø 3.0 mm  
165-700-003

ø 4.0 mm  
165-700-004

ø 5.0 mm  
165-700-005

ø 6.0 mm  
165-700-006

**Schmid**  
15.0 cm, 6"  
Gefäßspülkanülen, biegsam  
Vessel irrigating cannulas,  
malleable

Kanülen zum Einbinden in die Vene  
Cannulas, venous  
ø 1.20 x 80 mm, 18 G x 3 1/8"  
**165-705-120**  
ø 1.50 x 80 mm, 17 G x 3 1/8"  
**165-705-150**

**Mock**  
Gefäßspülkanüle  
Vessel irrigating cannula  
6.0 cm, 2 3/8"  
**165-710-060**



**Veress Nadel**  
**Veress Needle**  
ø 2.00 x 100 mm, 14 G x 4"  
**300-195-100**  
ø 2.00 x 120 mm, 14 G x 4 3/4"  
**165-195-120**



**Seldinger-Stille**  
**Arteriographiekanülen**  
**Arteriography needles**  
ø 1.60 x 70 mm, 16 G x 2 3/4"  
**165-716-160**  
ø 2.00 x 70 mm, 14 G x 2 3/4"  
**165-716-205**



**Klima-Rossegger**  
**Kanüle zur Sternal-Punktion**  
**Sternum puncture needle**  
ø 1.60 x 40 mm, 16 G x 1 5/8"  
**165-049-037**

Kanülen zur Lumbalpunktion  
Lumbar puncture needles



**Bier**



**Quinke**



**Tuhoj**

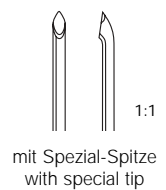

ø 3.00 x 90 mm, 11 G x 3 1/2"	<b>165-049-092</b>
ø 2.80 x 90 mm, 12 G x 3 1/2"	<b>165-049-093</b>
ø 2.40 x 90 mm, 13 G x 3 1/2"	<b>165-049-094</b>
ø 2.10 x 90 mm, 14 G x 3 1/2"	<b>165-049-095</b>
ø 1.80 x 90 mm, 15 G x 3 1/2"	<b>165-049-096</b>
ø 1.60 x 90 mm, 16 G x 3 1/2"	<b>165-049-097</b>

ø 1.20 x 76 mm, 18 G x 3"	<b>165-049-076</b>
ø 1.20 x 89 mm, 18 G x 3 1/2"	<b>165-049-077</b>
ø 1.00 x 76 mm, 19 G x 3"	<b>165-049-078</b>
ø 1.00 x 89 mm, 19 G x 3 1/2"	<b>165-049-079</b>
ø 0.70 x 76 mm, 22 G x 3"	<b>165-049-080</b>
ø 0.70 x 50 mm, 22 G x 2"	<b>165-049-081</b>
ø 0.70 x 89 mm, 22 G x 3 1/2"	<b>165-049-082</b>

ø 1.20 x 76 mm, 18 G x 3"	<b>165-047-120</b>
ø 1.40 x 76 mm, 17 G x 3"	<b>165-047-140</b>
ø 1.60 x 76 mm, 16 G x 3"	<b>165-047-160</b>



**Menghini**

Kanülen für die Leberblindpunktion  
 einschließlich Stopsonde  
 Liver blind puncture needles with  
 stopping probe

∅ 1.00 x 35 mm, 19 G x 1 3/8"	<b>165-050-001</b>
∅ 1.00 x 70 mm, 19 G x 2 3/4"	<b>165-050-002</b>
∅ 1.20 x 70 mm, 18 G x 2 3/4"	<b>165-050-003</b>
∅ 1.20 x 100 mm, 18 G x 4"	<b>165-050-004</b>
∅ 1.40 x 70 mm, 17 G x 2 3/4"	<b>165-050-005</b>
∅ 1.40 x 100 mm, 17 G x 4"	<b>165-050-006</b>
∅ 1.60 x 70 mm, 16 G x 2 3/4"	<b>165-050-007</b>
∅ 1.80 x 100 mm, 15 G x 4"	<b>165-050-008</b>



**Menghini**

Kanülen zur gezielten Leberpunktion  
 Needles for controlled liver puncture

∅ 1.40 x 168 mm, 17 G x 3"	<b>165-055-140</b>
∅ 1.80 x 168 mm, 15 G x 6 3/4"	<b>165-055-180</b>



Trocar zum Einführen der  
 Leberpunktionkanülen  
 Trocar for introduction of liver puncture  
 needles

∅ 1.40 x 168 mm, 17 G x 3"	<b>165-056-140</b>
∅ 1.80 x 168 mm, 15 G x 6 3/4"	<b>165-056-180</b>



Zwischenstück  
 LLA weibl.-RC männl.  
 Adapter LLA female -  
 RC male  
**300-011-504**



Zwischenstück  
 LA männl.  
 Adapter LA male  
**300-011-505**



Schlauch-Olive  
 LLA männl.  
 Hose end with LLA male  
 ∅ 6 mm  
**300-011-506**  
 ∅ 8 mm  
**300-011-508**



Schlauch-Olive  
 LLA weibl.  
 Hose end with LLA  
 female  
**300-011-509**



Schlauch-Olive  
 RC weibl.-RC männl.  
 Hose end RC female -  
 RC male  
**300-011-510**



Durchflußhahn  
 LLA weibl.-LLA männl.  
 One-way stopcock  
 LLA female-LLA male  
**300-011-511**



Durchflußhahn  
 LLA weibl.  
 One way stopcock  
 LLA female  
**300-011-512**



Dreiweghahn  
 1 LLA männl.-2 LLA weibl.  
 Three-way stopcock  
 1 LLA male-2 LLA female  
**300-011-513**



Dreiweghahn  
 3 LLA weiblich  
 Three-way stopcock  
 3 LLA female  
**300-011-514**



RZ-Spritzen werden den Forderungen der ärztlichen Praxis in Einfachheit und Zuverlässigkeit im Gebrauch in jeder Weise gerecht.

Vorzüge:

- Kolben und Glaszylinder der RZ-Spritzen sind untereinander beliebig austauschbar; Ersatzteile können in stets passender Ausführung nachgeliefert werden.
- Der Zylinder ist glasklar und zeigt, ebenso wie der Kolben aus nichtrostendem Stahl, selbst nach langem Gebrauch keine Zeichen der Abnutzung.
- Keine Bruchgefahr, wenn die RZ-Spritze zum Sterilisieren nicht auseinander genommen wird.
- Eine neuartige Kolbenbremse in der Sechskantkappe erübrigt den Kolbenring. Der Kolben ist glatt und gewährleistet daher eine erhöhte Dichtigkeit.

RZ Syringes fulfill the demands of medical practice in simplicity and reliability in every way.

Features:

- Plunger and glass cylinder of the RZ Syringes can be interchanged as desired. Replacement parts can be supplied subsequently to fit.
- The cylinder is transparent and even after long use shows no signs of wear, as does the stainless steel plunger.
- There is no danger of breakage if the RZ Syringe is not taken to pieces for sterilising.
- A new type of plunger brake in the hexagonal cap allows a piston ring to be dispensed with. The plunger is smooth and so ensures enhanced tightness.



	Luer	Zylinder, barrels
1 ml	165-850-010	165-851-010
2 ml	165-850-020	165-851-020
5 ml	165-850-050	165-851-050
10 ml	165-850-100	165-851-100
20 ml	165-850-200	165-851-200
50 ml	165-850-500	165-851-500



	Luer Lock	Zylinder, barrels
1 ml	165-800-010	165-801-010
2 ml	165-800-020	165-801-020
5 ml	165-800-050	165-801-050
10 ml	165-800-100	165-801-100
20 ml	165-800-200	165-801-200
50 ml	165-800-500	165-801-500



	Luer Lock	Zylinder, barrels
2 ml	165-855-020	165-856-020
5 ml	165-855-050	165-856-050
10 ml	165-855-100	165-856-100



	Insulin Luer	Zylinder, barrels
1 ml	165-859-010	165-860-010
2 ml	165-859-020	165-860-020





Tuberkulin Luer-Lock Zylinder, barrels		
1 ml	165-857-010	165-858-010



Janet Zylinder, barrels		
50 ml	165-860-050	165-861-050
100 ml	165-860-100	165-861-100
150 ml	165-860-150	165-861-150
200 ml	165-860-200	165-861-200



Luer Lock Druckspritze für Arteriographie und Angiographie Pressure syringe for arteriography and angiography Zylinder, barrels		
10 ml	165-865-010	165-866-010
20 ml	165-865-020	165-866-020
30 ml	165-865-030	165-866-030
50 ml	165-865-050	165-866-050



Toomey	
50 ml	253-450-050

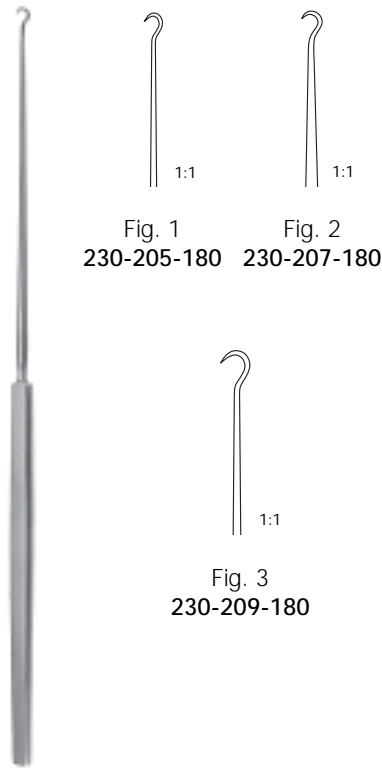

**Gillies**  
 18.0 cm, 7"

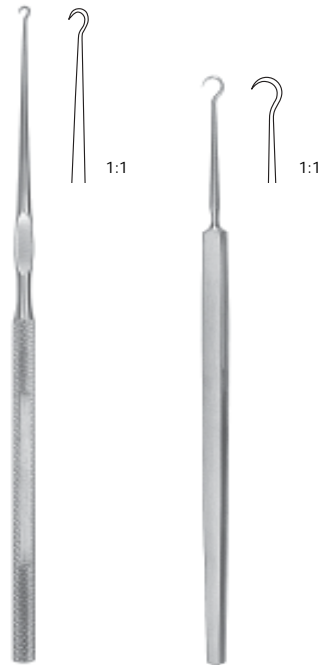

**Kilner**  
 15.0 cm, 6"  
 230-203-150

**Frazier**  
 13.0 cm, 5"  
 170-013-130

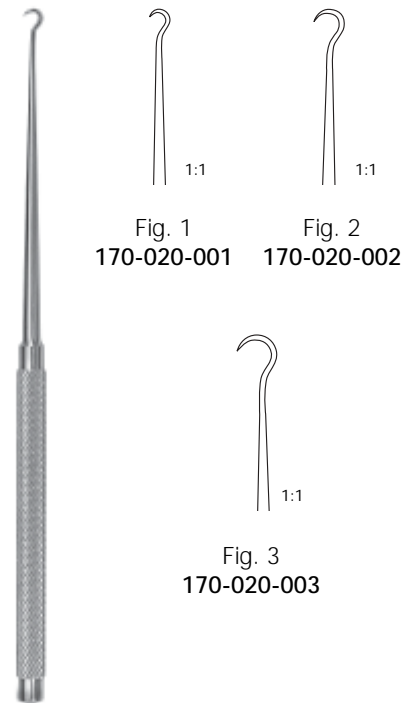

**Kleinert-Kutz**  
 16.0 cm, 6 1/4"

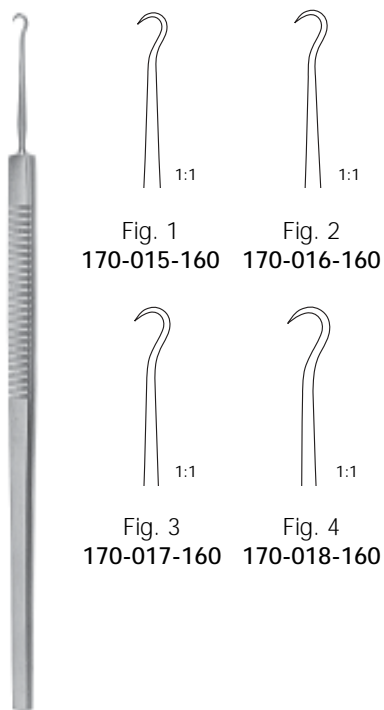

**O'Connor**  
 16.0 cm, 6 1/4"  
 170-040-160



**O'Connor**  
 16.0 cm, 6 1/4"  
 170-040-160

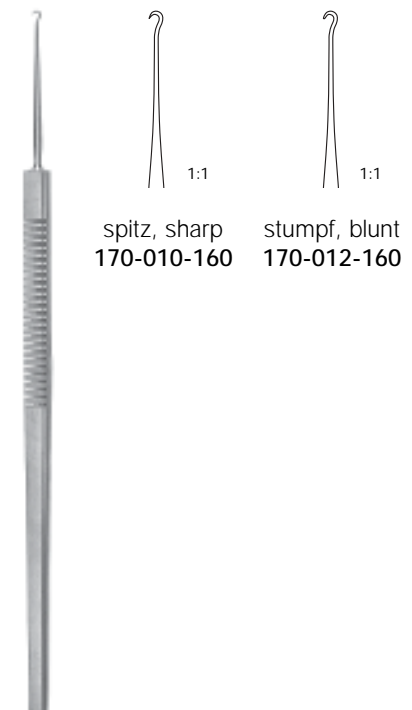

**Graefe**  
 16.0 cm, 6 1/4"



flexibel, flexible  
 16.0 cm, 6 1/4"

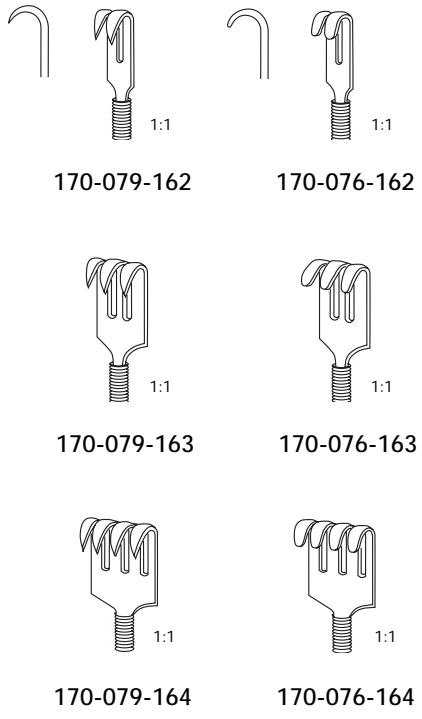

**Joseph**  
 16.0 cm, 6 1/4"  
 170-014-001

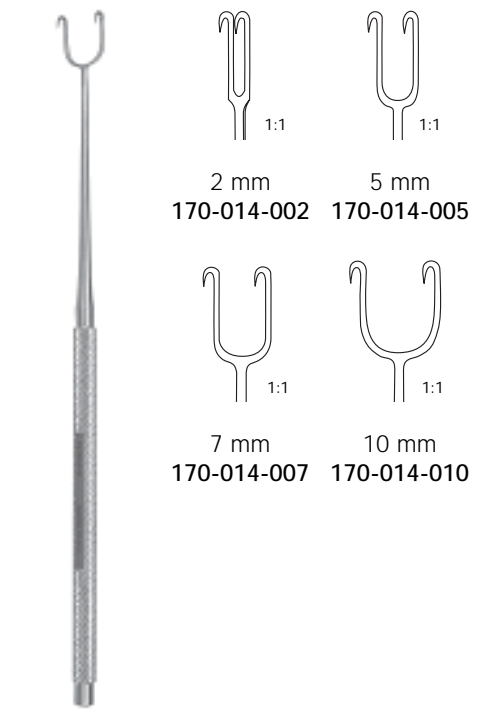

**Joseph**  
 16.0 cm, 6 1/4"



**Guthrie**  
 16.0 cm, 6 1/4"

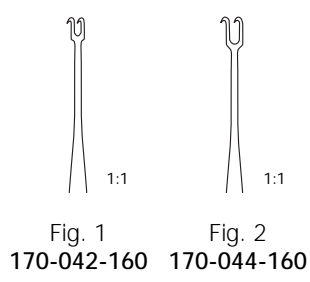

**Knapp**  
 13.0 cm, 5"

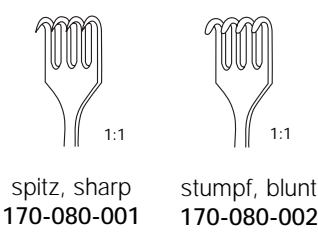

**Langenbeck-Green**  
 16.0 cm, 6 1/4"

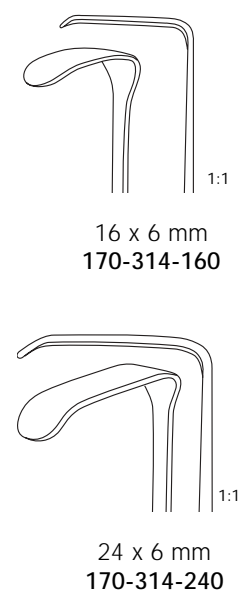

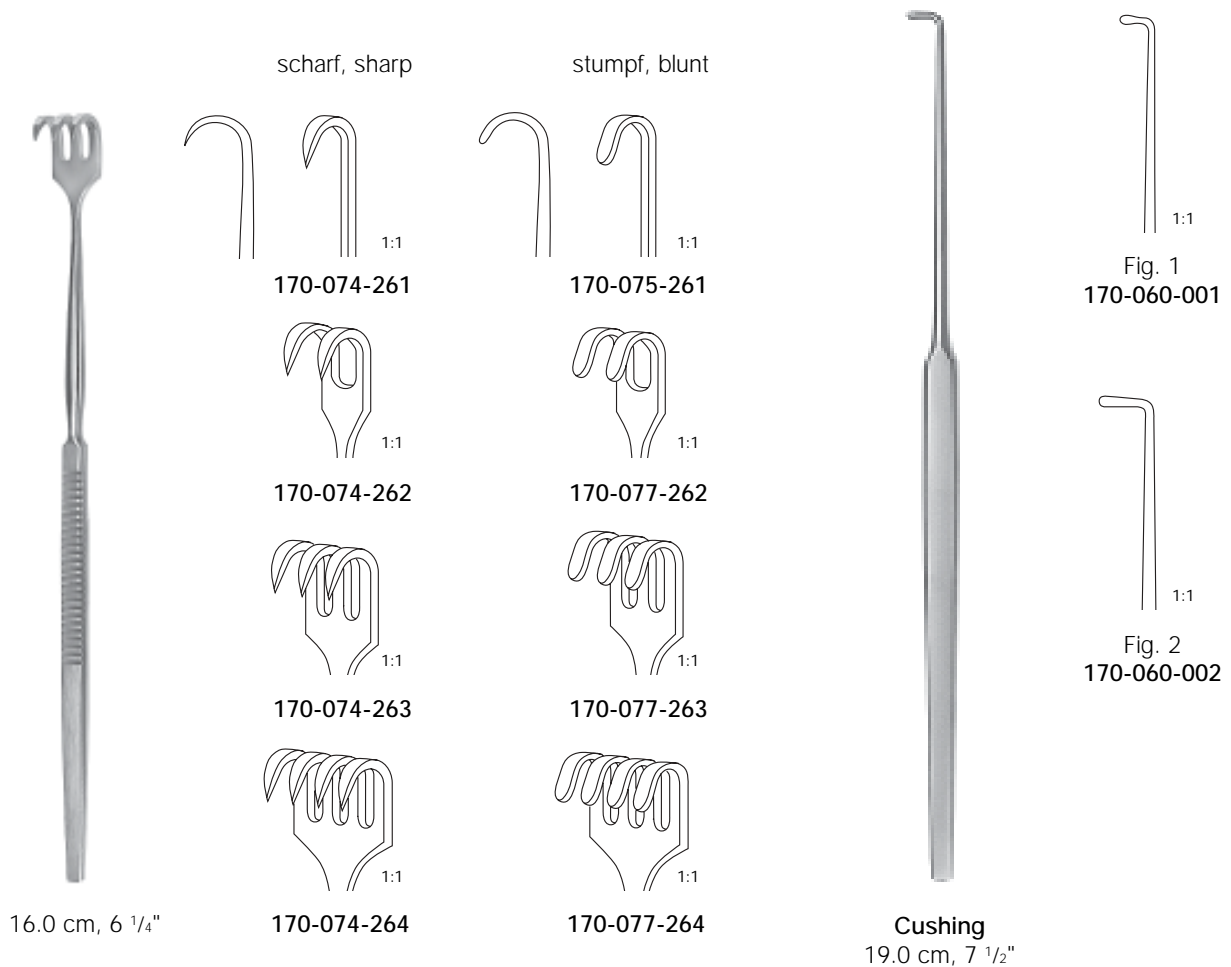
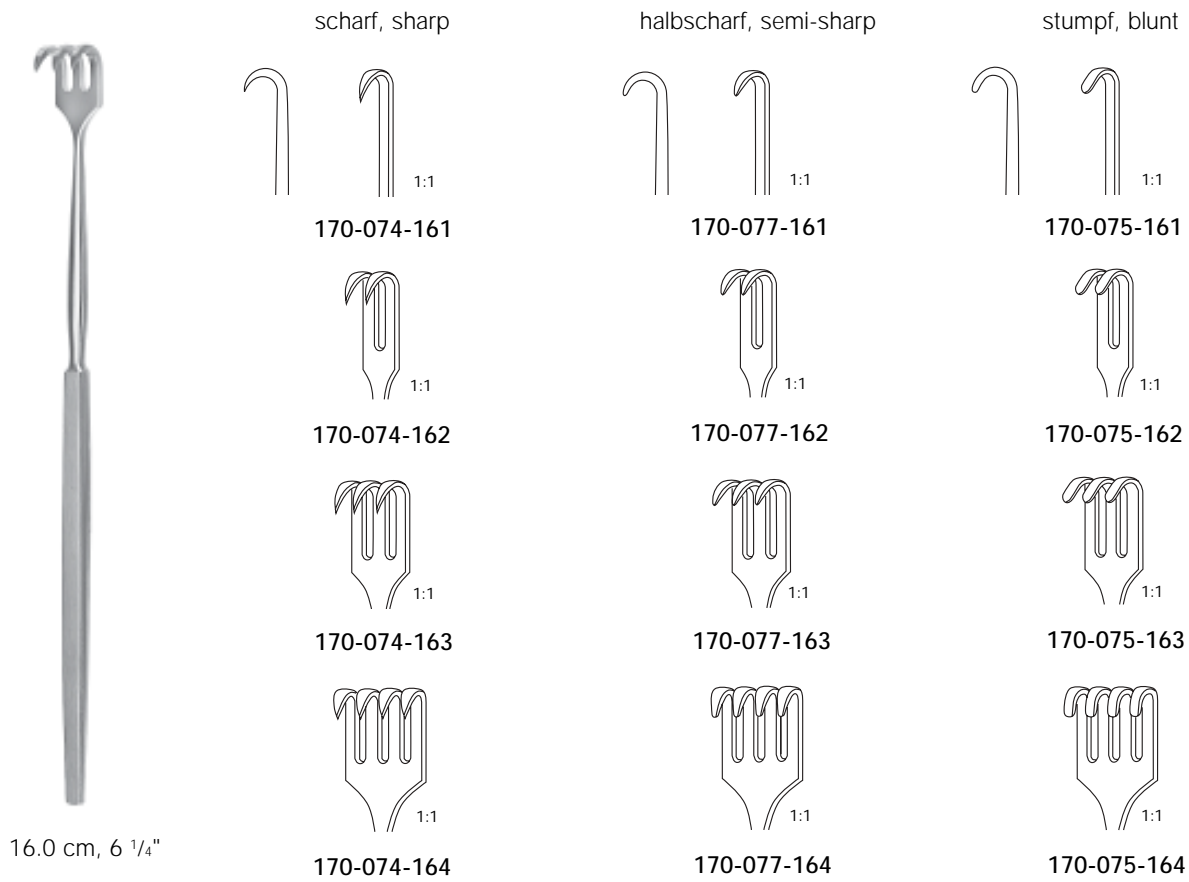

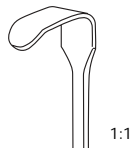

18 x 7 mm  
170-079-181

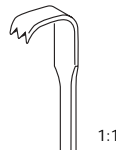

7 x 4 mm  
170-079-183

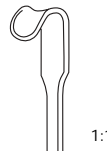

7 x 4 mm  
170-079-185

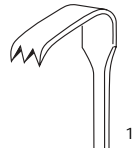

16 x 5 mm  
170-079-182

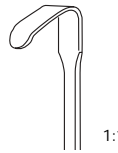

10 x 3 mm  
170-079-184

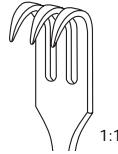

4 x 10 mm  
170-079-186

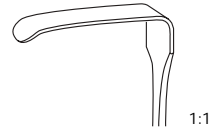

10 x 6 mm  
170-209-150

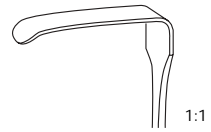

20 x 6 mm  
170-208-150

Meyerding  
18.0 cm, 7"

Senn-Green  
15.0 cm, 6"

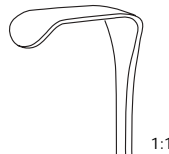

10 x 6 mm  
170-130-160

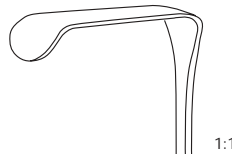

17 x 5 mm  
170-131-160

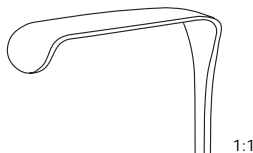

20 x 6 mm  
170-132-160

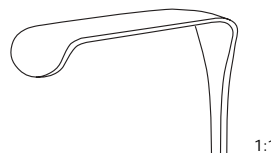

22 x 8 mm  
170-133-160

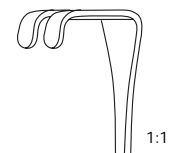

14 x 8 mm  
170-134-160

Mini-Langenbeck  
16.0 cm, 6 1/4"

16.0 cm, 6 1/4"

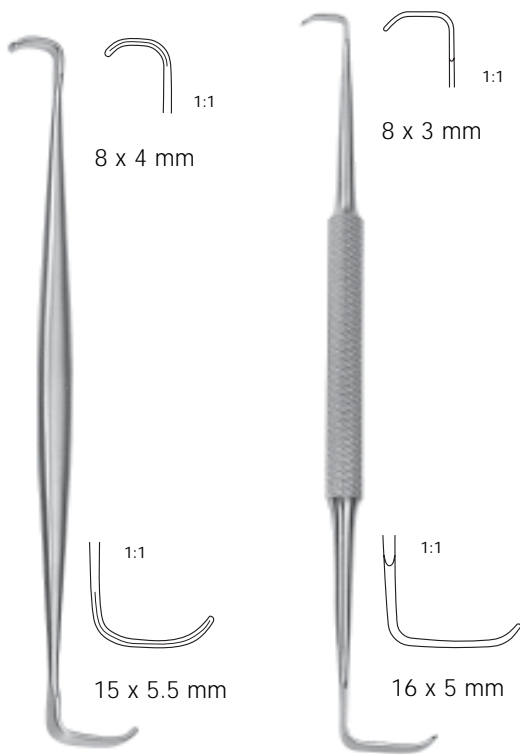

**Ragnell-Davis**  
14.0 cm, 5 1/2"  
170-207-140

**Ragnell**  
15.0 cm, 6"  
170-206-150



**Senn-Miller**  
16.0 cm, 6 1/4"

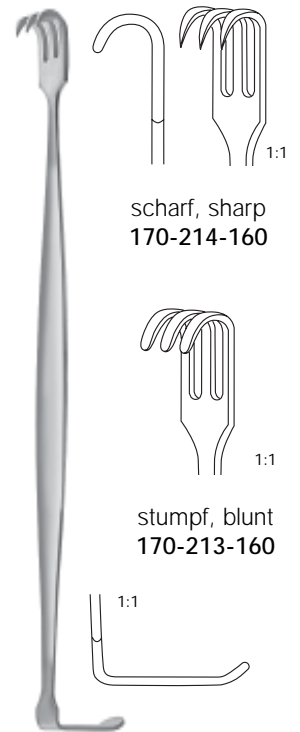

**Baby-Senn-Miller**  
15.0 cm, 6"

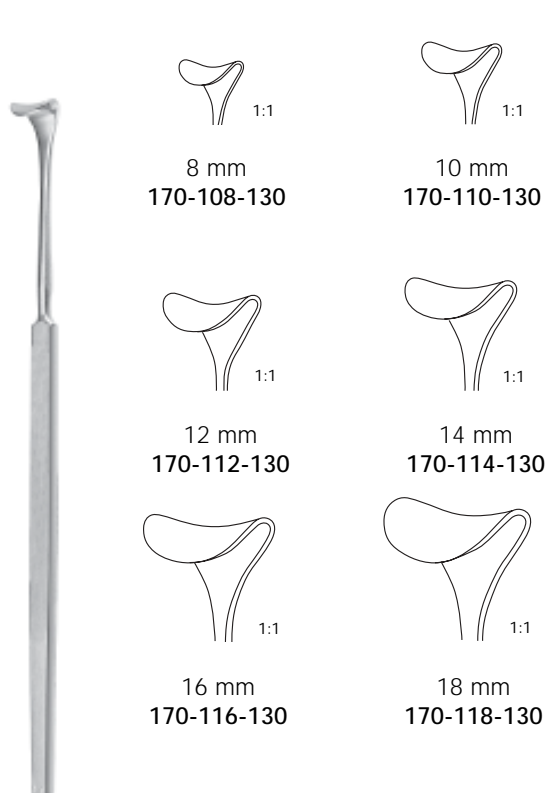

**Desmarres**  
13.0 cm, 5"

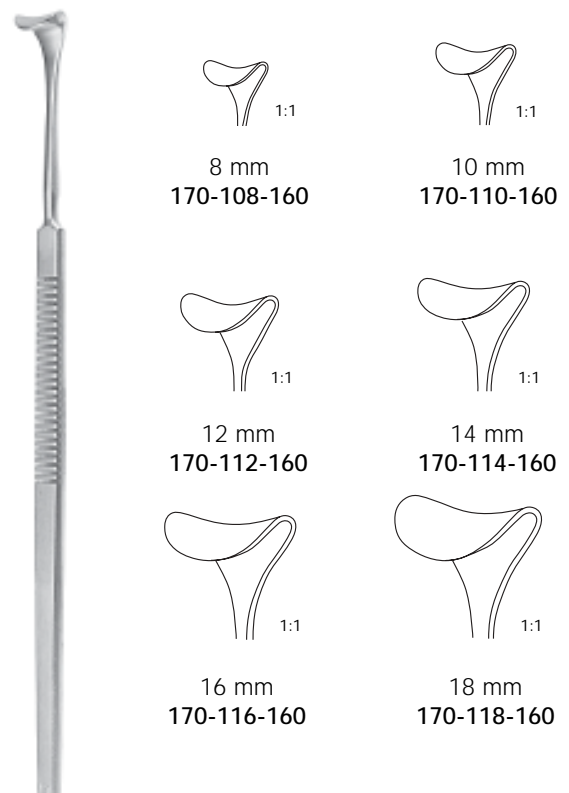

**Desmarres**  
16.0 cm, 6 1/4"

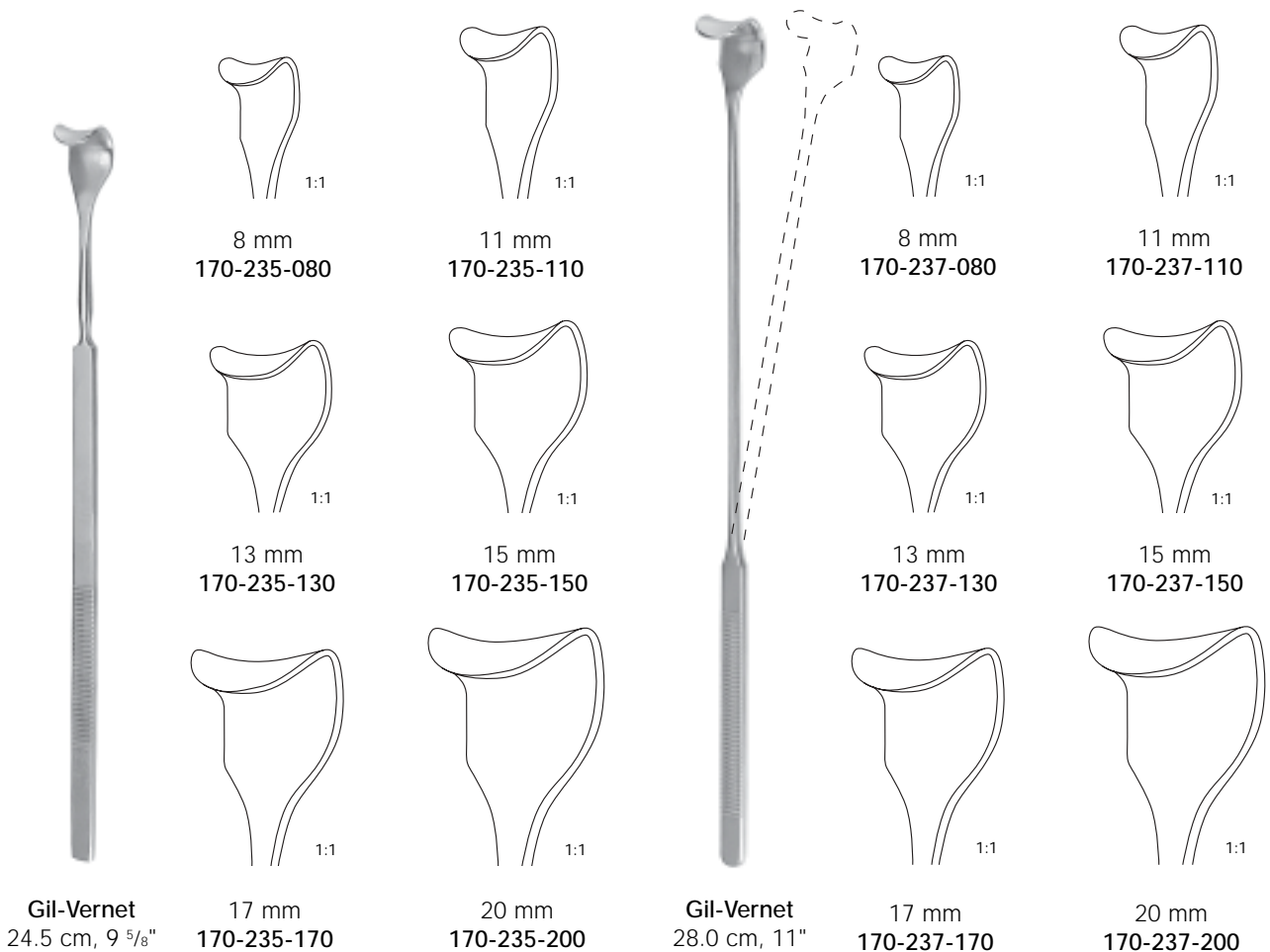
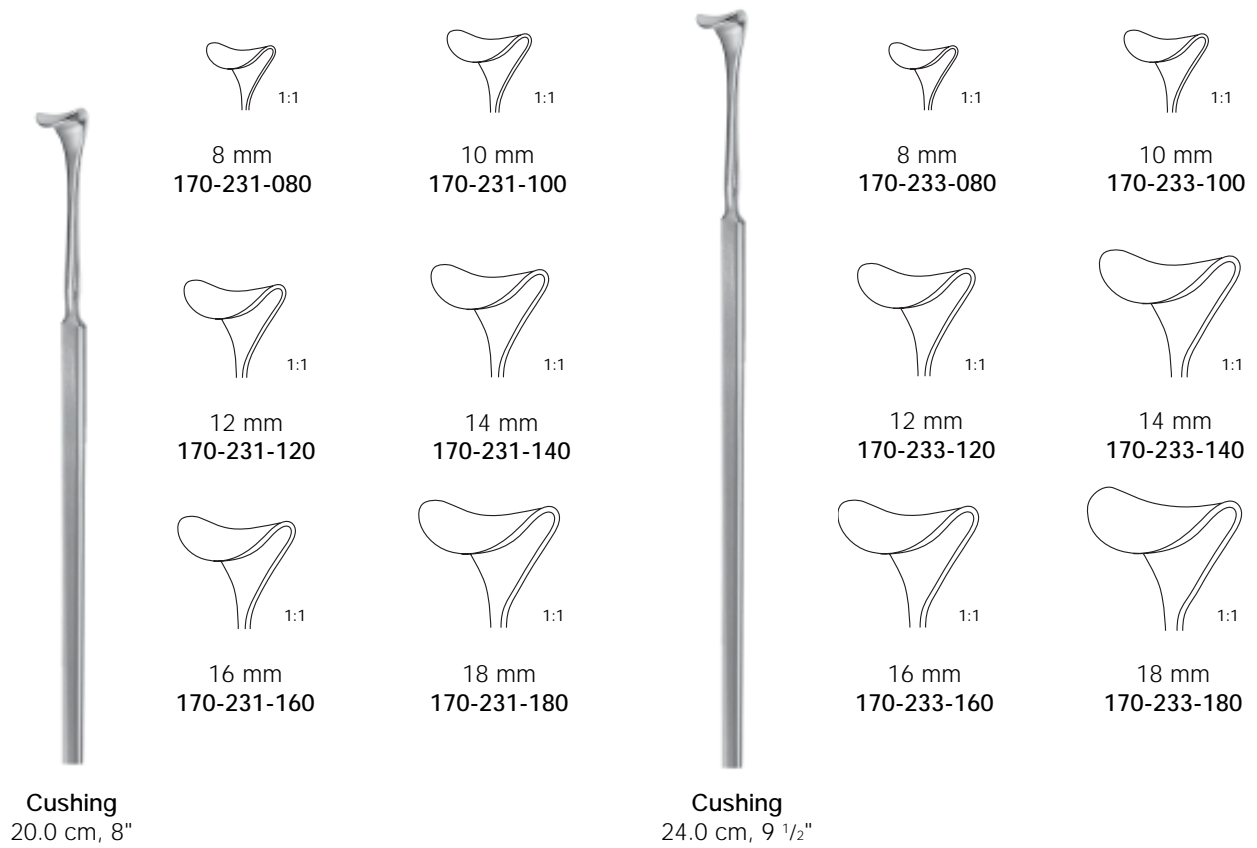



**Volkmann**  
21.5 cm, 8 1/2"

scharf, sharp

9 x 8 mm	9 x 13 mm	9 x 19 mm	9 x 29 mm	9 x 40 mm
170-220-215	170-222-215	170-224-215	170-226-215	170-228-215

halbscharf, semi-sharp

9 x 8 mm	9 x 13 mm	9 x 19 mm	9 x 29 mm	9 x 40 mm
170-231-215	170-233-215	170-235-215	170-237-215	170-239-215

stumpf, blunt

9 x 8 mm	9 x 13 mm	9 x 19 mm	9 x 29 mm	9 x 40 mm
170-221-215	170-223-215	170-225-215	170-227-215	170-229-215

**Kocher**  
22.0 cm, 8 5/8"

scharf, sharp

9 x 8 mm	15 x 15 mm	15 x 20 mm	15 x 30 mm	15 x 40 mm
170-310-221	170-310-222	170-310-223	170-310-224	170-310-226

halbscharf, semi-sharp

9 x 8 mm	15 x 15 mm	15 x 20 mm	15 x 30 mm	15 x 40 mm
170-312-221	170-312-222	170-312-223	170-312-224	170-312-226

stumpf, blunt

9 x 8 mm	15 x 15 mm	15 x 20 mm	15 x 30 mm	15 x 40 mm
170-311-221	170-311-222	170-311-223	170-311-224	170-311-226





**Koerte**  
8 Zähne, 8 prongs  
24.0 cm, 9 1/2"

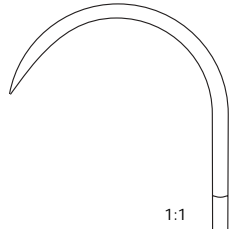

26 x 40 mm  
scharf, sharp  
170-218-008

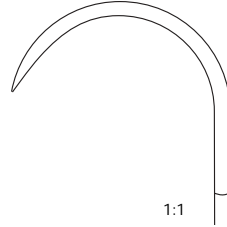

26 x 40 mm  
stumpf, blunt  
170-219-008



**Israel**  
25.0 cm, 9 3/4"

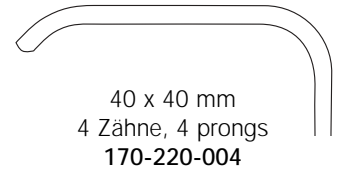

40 x 40 mm  
4 Zähne, 4 prongs  
170-220-004

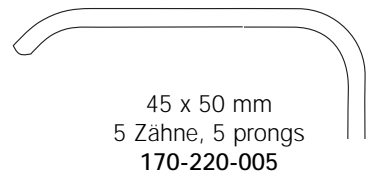

45 x 50 mm  
5 Zähne, 5 prongs  
170-220-005

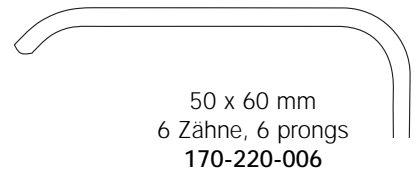

50 x 60 mm  
6 Zähne, 6 prongs  
170-220-006

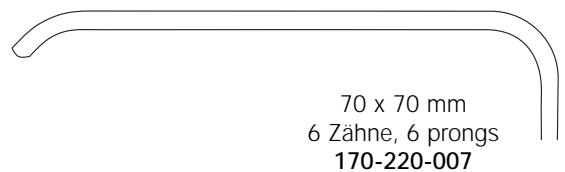

70 x 70 mm  
6 Zähne, 6 prongs  
170-220-007



Langenbeck  
21.0 cm, 8 1/4"

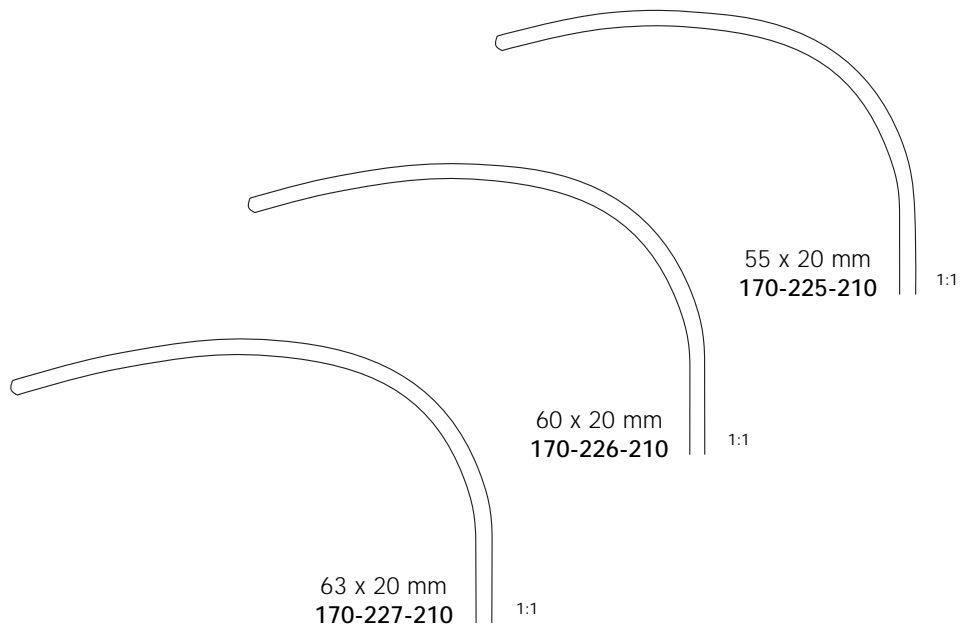

Langenbeck  
22.0 cm, 8 5/8"  
170-222-...

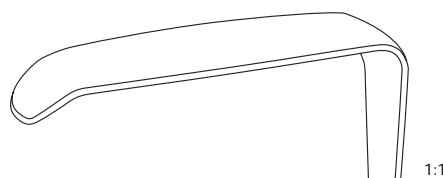
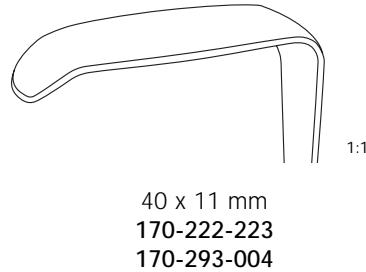
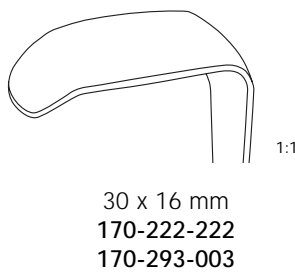
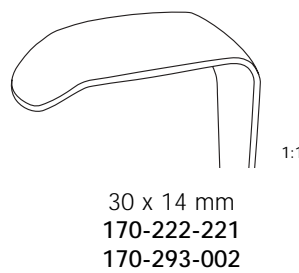
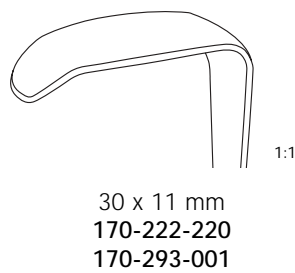

Langenbeck  
22.0 cm, 8 5/8"  
170-293-...



Kocher-Langenbeck  
21.5 cm, 8 1/2"

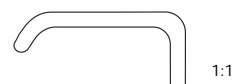

22 x 6 mm  
170-317-022

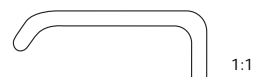

25 x 8 mm  
170-317-025

25 x 6 mm  
170-317-026

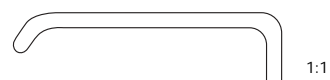

35 x 8 mm  
170-317-035

35 x 11 mm  
170-317-036

35 x 15 mm  
170-317-037

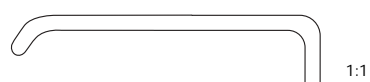

40 x 11 mm  
170-317-040



55 x 11 mm  
170-317-055

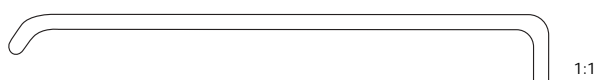

70 x 15 mm  
170-317-070

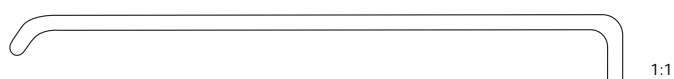

80 x 12 mm  
170-317-080

80 x 15 mm  
170-317-081



**Kocher**  
23.0 cm, 9"



40 x 18 mm  
170-315-018



60 x 20 mm  
170-315-020

60 x 25 mm  
170-315-025

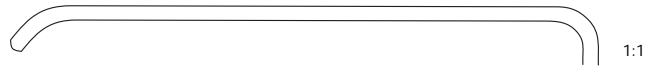

75 x 30 mm  
170-315-030

75 x 40 mm  
170-315-040



**Sauerbruch**  
22.5 cm, 8 3/4"

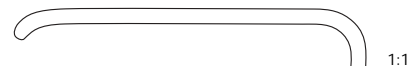

44 x 16 mm  
170-561-001

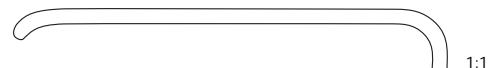

55 x 22 mm  
170-561-002

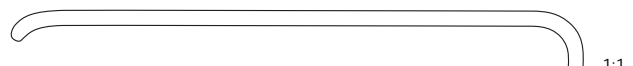

72 x 19 mm  
170-561-003



Brunner

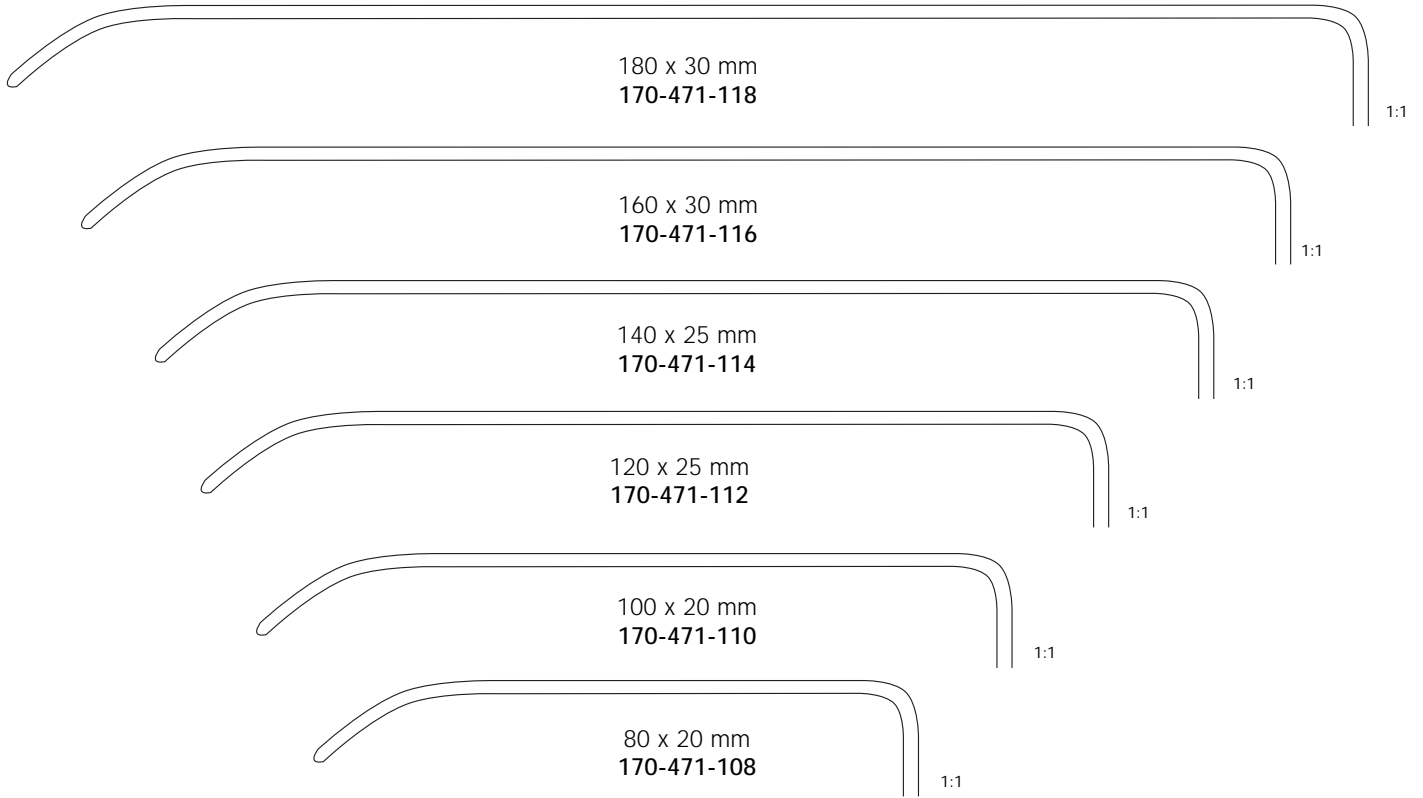

Brunner  
21.0 cm, 8 1/4"



Lahey  
19.0 cm, 7 1/2"  
170-312-190



Little  
20.0 cm, 8"  
170-313-200



Middeldorpf  
170-363-...

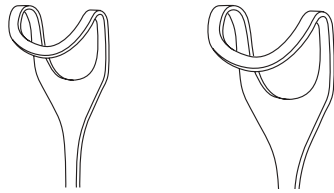

21.5 mm, 8 1/2"  
14 x 17 mm  
170-363-001  
170-325-001

22.0 mm, 8 5/8"  
20 x 22 mm  
170-363-002  
170-325-002

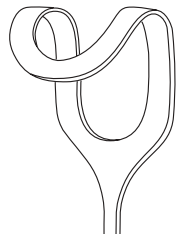

23.5 mm, 9 1/4"  
26 x 30 mm  
170-363-003  
170-325-003



Middeldorpf  
170-325-...

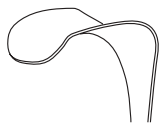

28 x 20 mm  
170-383-001

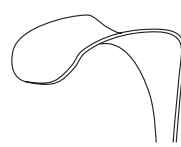

36 x 28 mm  
170-383-002

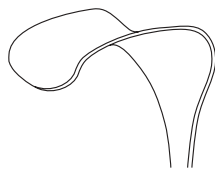

44 x 38 mm  
170-383-003

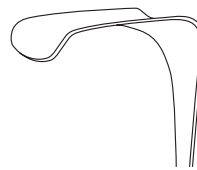

52 x 22 mm  
170-383-004

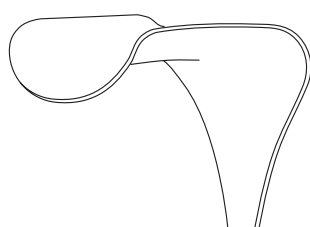

65 x 50 mm  
170-383-005

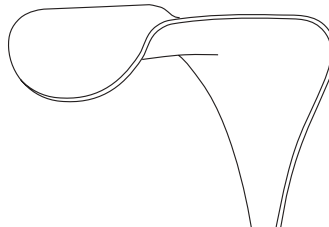

70 x 65 mm  
170-383-006



Richardson (Kelly)  
24.0 cm, 9 1/2"

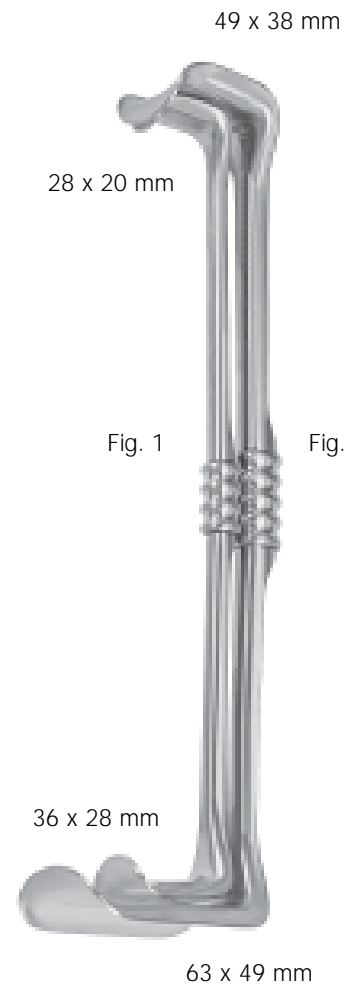

Fig. 1

Fig. 2

Richardson-  
Eastman  
Fig. 1+2  
170-381-000

Fig. 1  
26.0 cm, 10 1/4"  
170-381-001

Fig. 2  
28.0 cm, 11"  
170-381-002



**Doyen-Stiller**  
22.0 cm, 8 5/8"

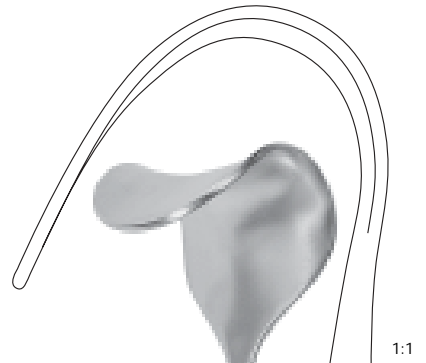
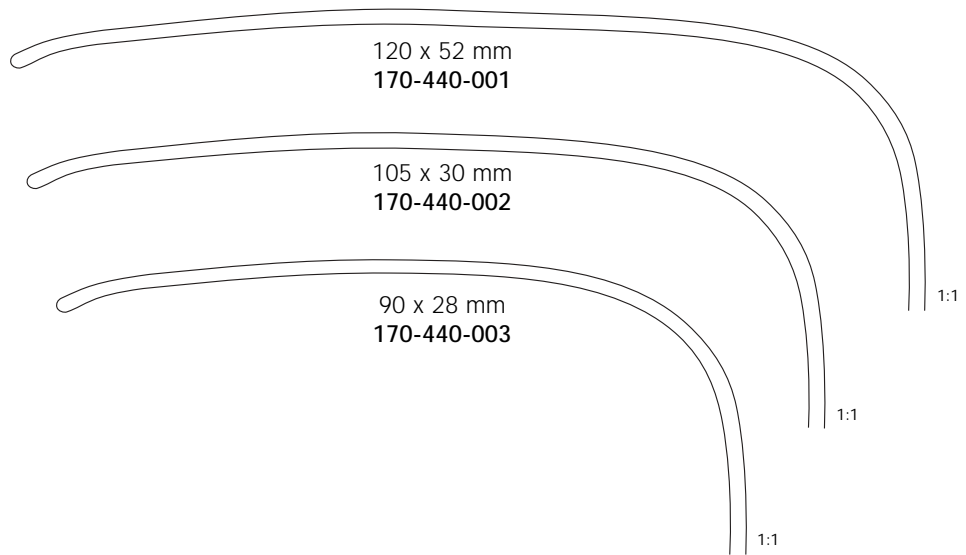

**Fritsch**  
24.0 cm, 9 1/2"

45 x 40 mm	170-447-040
45 x 50 mm	170-447-050
45 x 60 mm	170-447-060
55 x 75 mm	170-447-075
65 x 85 mm	170-447-085

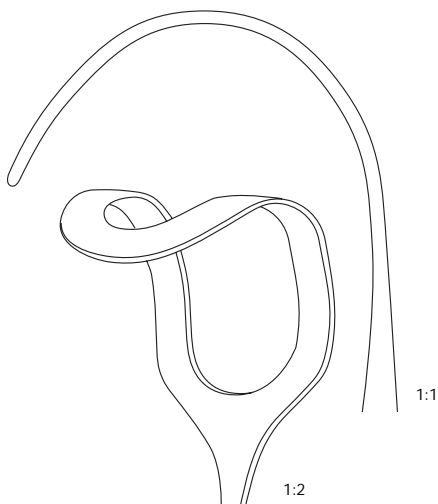

40 x 45 mm  
170-443-001

45 x 50 mm  
170-443-002

55 x 70 mm  
170-443-003



**Middeldorpf**  
25.5 cm, 10"



50 x 85 mm

**Doyen**  
25.0 cm, 10"  
170-461-250



115 x 22 mm  
170-457-001

115 x 27 mm  
170-457-002

1:1

**Simon**  
28.0 cm, 11"

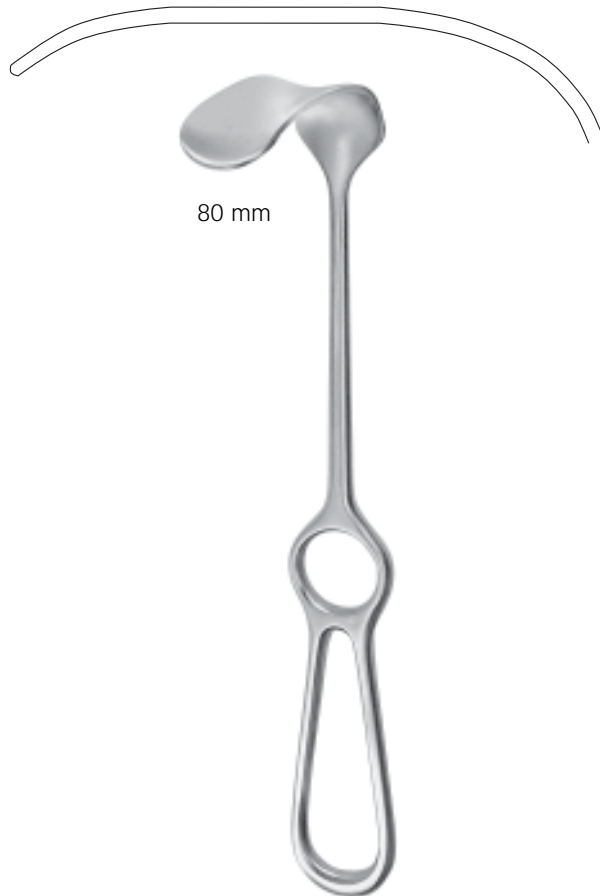

80 mm

1:1

**Kocher**

70 x 25 mm	22.0 cm, 9"	170-449-225
80 x 42 mm	25.0 cm, 10"	170-451-002
80 x 50 mm	25.0 cm, 10"	170-451-003
80 x 60 mm	25.0 cm, 10"	170-451-004





**Mikulicz**  
26.0 cm, 10 1/4"  
170-607-260

**Mikulicz**  
26.0 cm, 10 1/4"  
85 x 35 mm **170-489-001**  
120 x 50 mm **170-489-002**  
155 x 50 mm **170-489-003**

**Kelly**  
27.0 cm, 10 1/2"  
160 x 38 mm **170-531-260**  
160 x 57 mm **170-530-260**  
190 x 38 mm **170-533-260**  
190 x 57 mm **170-532-260**



**Morris**  
24.5 cm, 9 5/8"  
70 x 38 mm  
170-465-380  
70 x 50 mm  
170-465-510

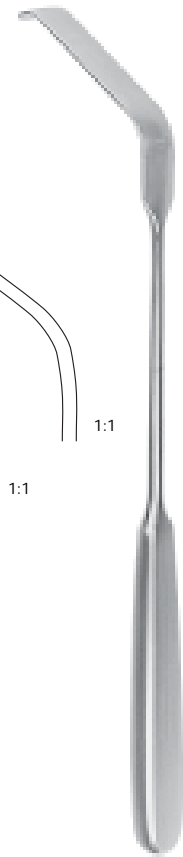
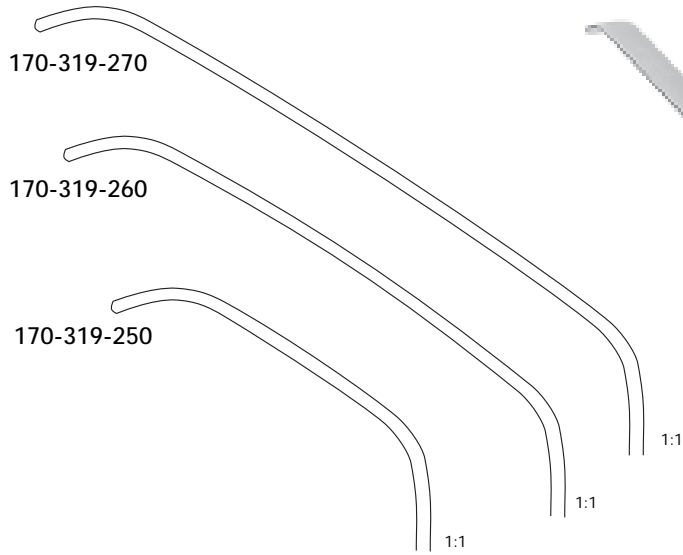

Zenker		
25.0 cm, 9 3/4"	35 x 8 mm	170-319-250
26.0 cm, 10 1/4"	60 x 12 mm	170-319-260
27.5 cm, 10 3/4"	75 x 12 mm	170-319-270



**Meyerding**  
22.5 cm, 8 3/4"

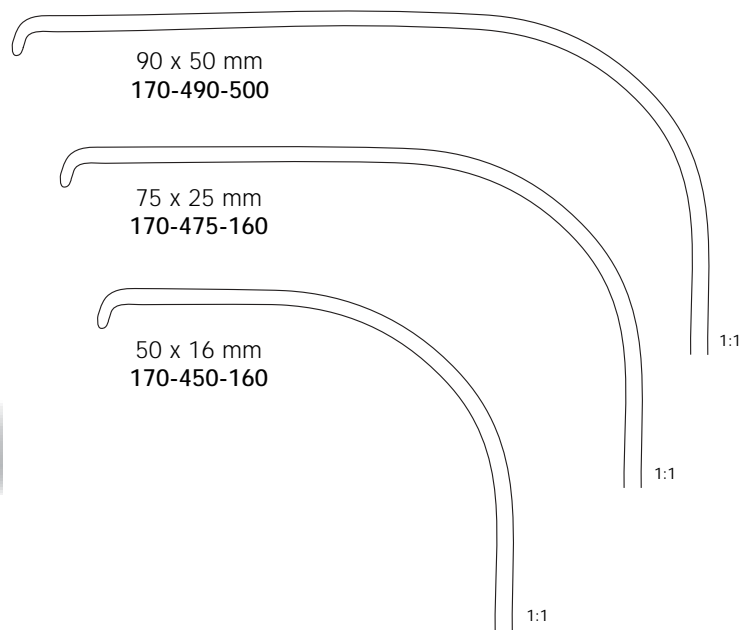

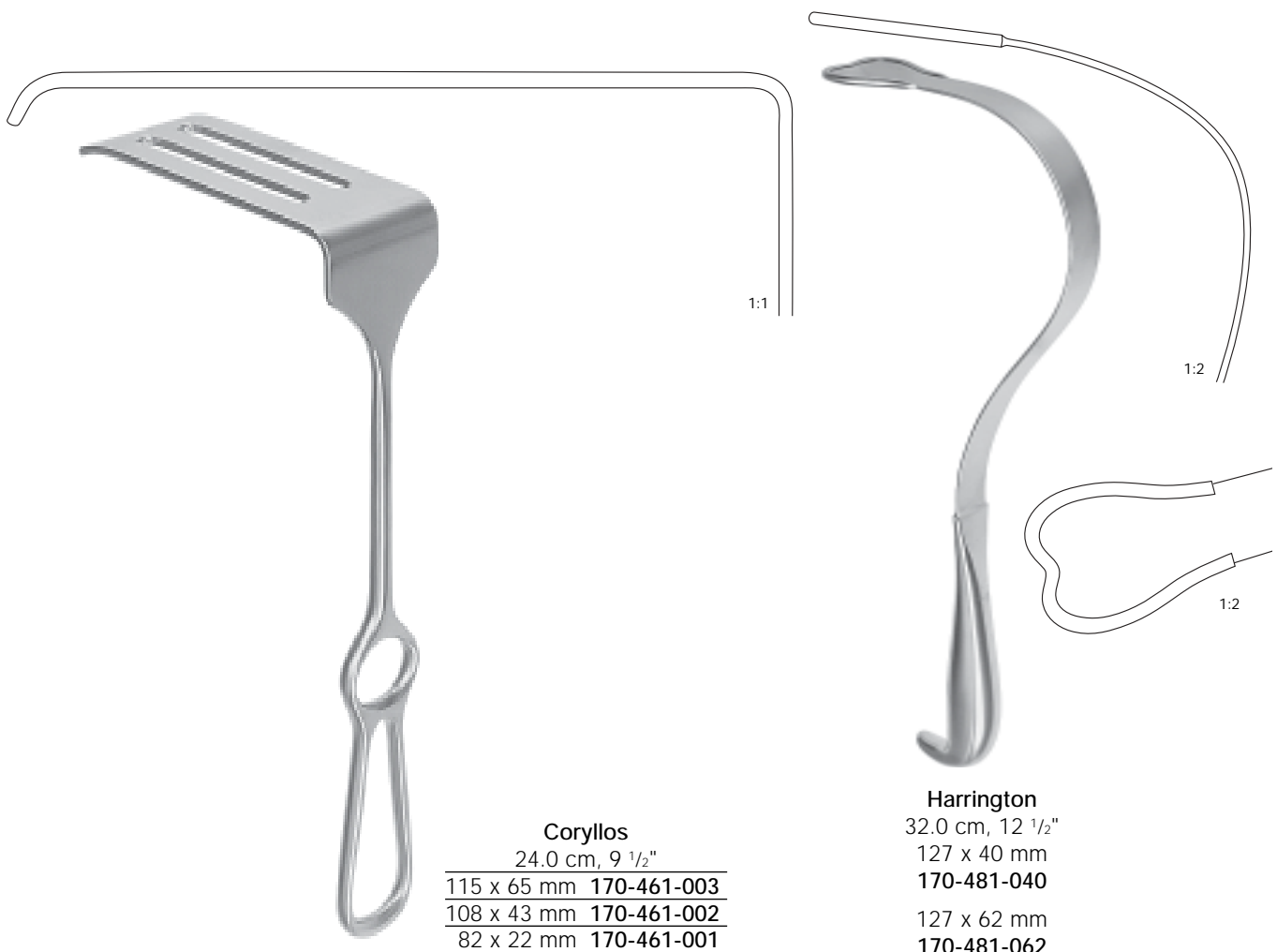
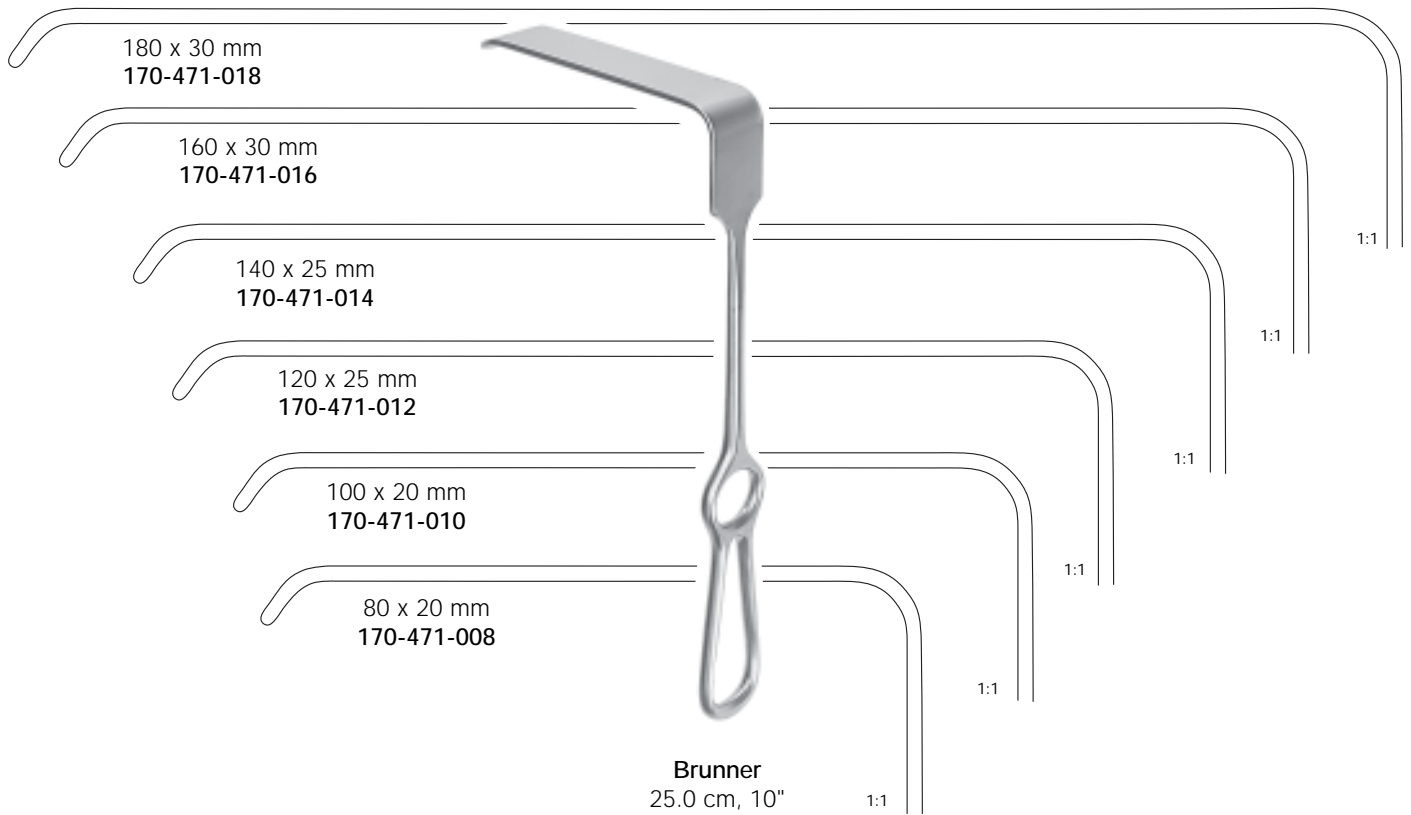



**Deaver Grip**  
30.0 cm, 12"  
170-483-...



**Deaver**  
18.0 cm, 7"  
170-591-180



**Deaver**  
21.5 cm, 8 1/2"  
170-591-215



**Deaver**  
23.0 cm, 9"  
170-591-230



**Deaver**  
30.0 cm, 12 3/4"  
170-591-300  
170-483-025



**Deaver**  
33.0 cm, 13"  
170-591-330



**Deaver**  
36.0 cm, 14 1/8"  
170-591-360



**Deaver**  
30.0 cm, 11 3/4"  
170-593-300  
170-483-038



**Deaver**  
30.0 cm, 11 3/4"  
170-595-300  
170-483-050



**Deaver**  
30.0 cm, 11 3/4"  
170-597-300  
170-483-075



**Allison**  
30.0 cm, 11 3/4"  
40 mm Breite/width  
**290-505-300**  
32.0 cm, 11 3/4"  
54 mm Breite/width  
**290-505-320**



**Davidson**  
16.0 cm, 6 1/4"  
75 x 50 mm  
**170-463-001**  
75 x 90 mm  
**170-463-002**



St. Marks

mit Lippe  
with lip

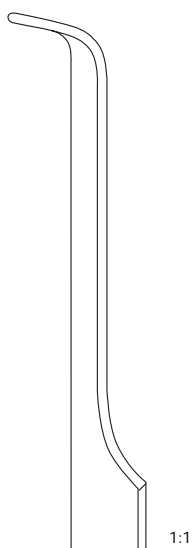

29.0 cm, 11 1/2"  
130 x 60 mm  
**170-493-001**

33.0 cm, 13"  
180 x 60 mm  
**170-493-002**

ohne Lippe  
without lip

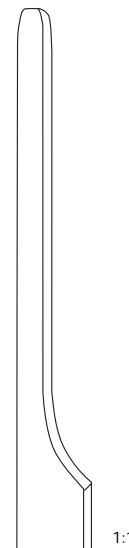

29.0 cm, 11 1/2"  
130 x 60 mm  
**170-493-004**

33.0 cm, 13"  
180 x 60 mm  
**170-493-003**



Fig. 1 24 x 20 mm  
Fig. 2 29 x 26 mm  
Fig. 3 33 x 29 mm  
Fig. 4 29 x 24 mm

Fig. 1 30 x 28 mm  
Fig. 2 36 x 36 mm  
Fig. 3 38 x 43 mm  
Fig. 4 45 x 28 mm

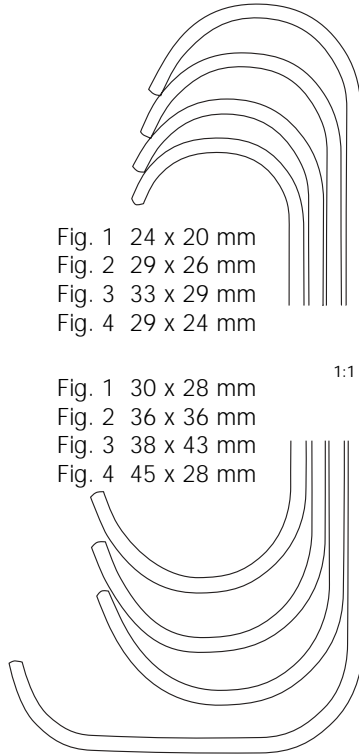

1:1



12.0 cm, 4 3/4"  
Fig. 1 30 x 10 mm  
Fig. 2 26 x 10 mm  
15.0 cm, 5 3/4"  
Fig. 1 23 x 16 mm  
Fig. 2 27 x 16 mm

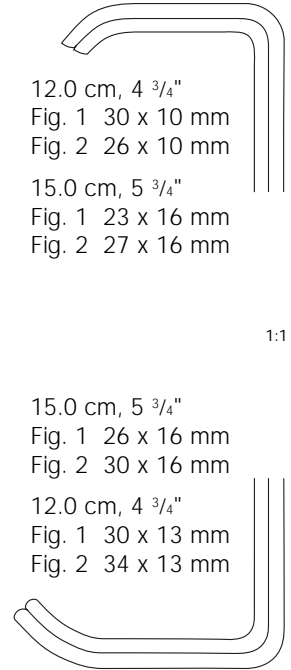

1:1

15.0 cm, 5 3/4"  
Fig. 1 26 x 16 mm  
Fig. 2 30 x 16 mm  
12.0 cm, 4 3/4"  
Fig. 1 30 x 13 mm  
Fig. 2 34 x 13 mm

**Roux**

Satz, Set: Fig. 1-3	170-655-000
Fig. 1 14.0 cm, 5 1/2"	170-655-140
Fig. 2 15.0 cm, 6"	170-655-150
Fig. 3 17.0 cm, 6 3/4"	170-655-170
Fig. 4 18.0 cm, 7"	170-655-180

**Farabeuf**

Satz, Set	
12.0 cm, 4 3/4"	170-663-120
15.0 cm, 6"	170-665-150



1:1

1:1

**Mini-Roux**  
14.0 cm, 5 1/2"  
170-667-006



1:1

1:1

**Baby-Roux**  
13.0 cm, 5"  
170-669-130

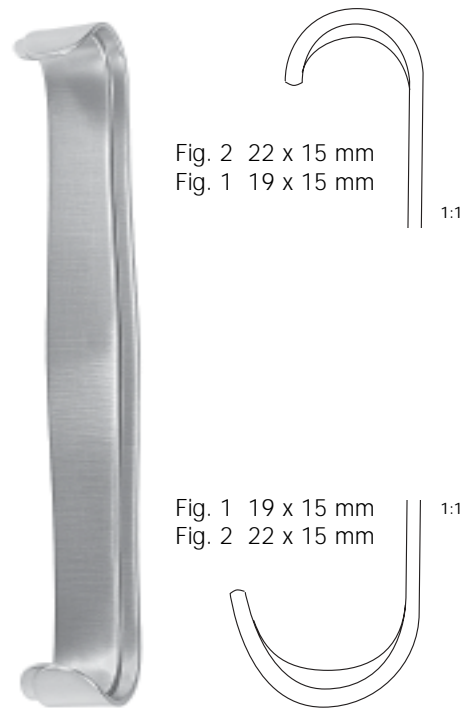

1:1

1:1

**Parker**  
Satz, Set  
13.5 cm, 5 3/8"  
170-673-001

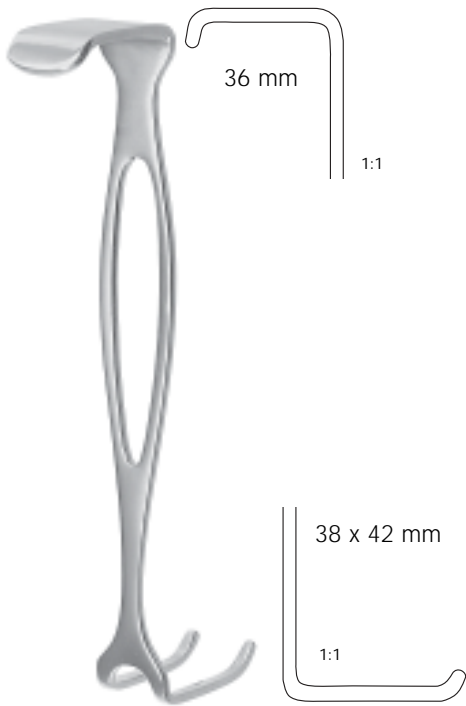

**Czerny**  
17.5 cm, 7"  
170-653-000



**Canny Ryal**  
19.0 cm, 7 1/2"  
16 mm  
170-654-016  
20 mm  
170-654-020  
20.0 cm, 8"  
25 mm  
170-654-025

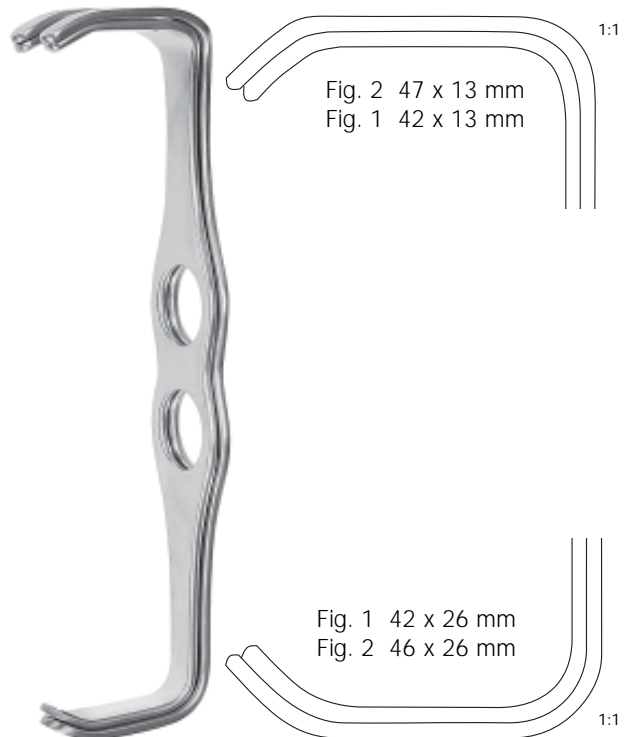

**Mathieu**  
Satz, Set  
20.0 cm, 8"  
170-683-000

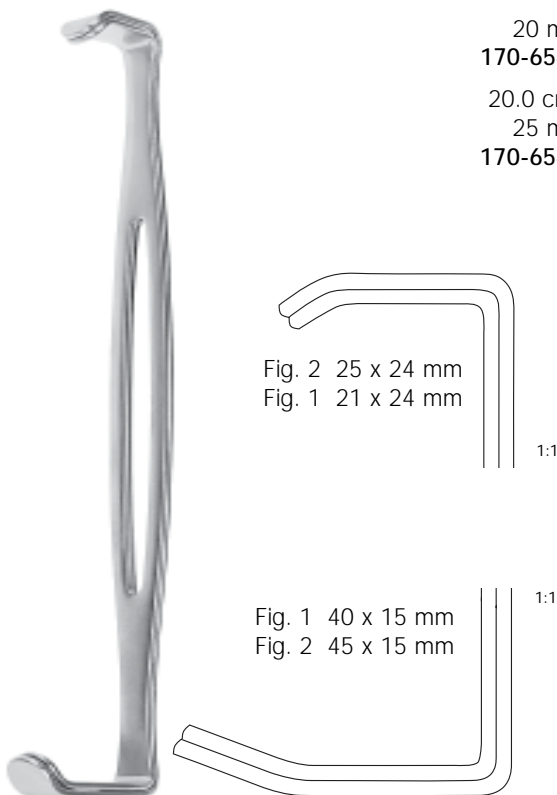

**Parker-Langenbeck**  
US-Modell, US-pattern  
Satz, Set  
21.0 cm, 8 1/4"  
170-687-210

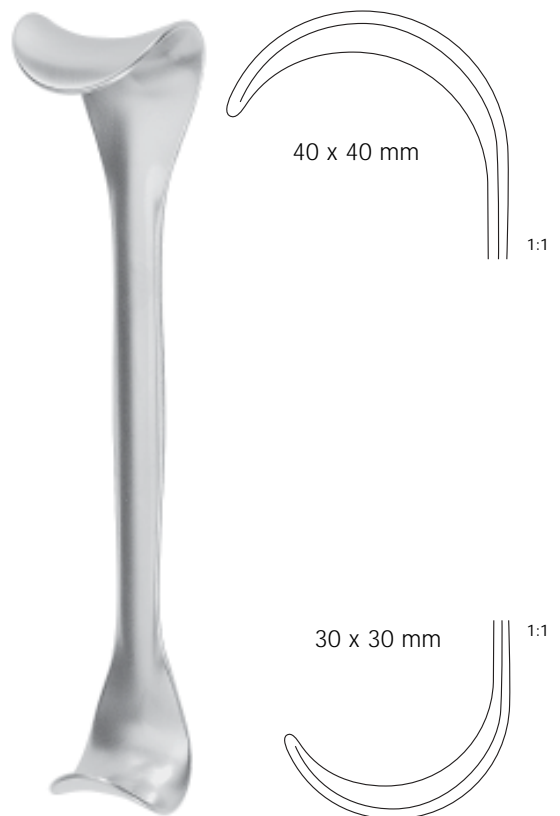

**Goelet**  
19.0 cm, 7 1/2"  
170-695-000

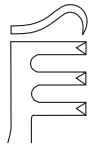

1:1

scharf, sharp  
170-700-050

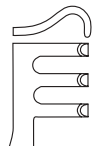

1:1

stumpf, blunt  
170-701-050



**Finsen**

3 x 3 Zähne, teeth  
5.0 cm, 2"



**Jansen**

3 x 3 Zähne, teeth  
10.0 cm, 4"

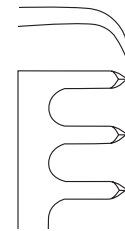

1:1

scharf, sharp  
170-720-100

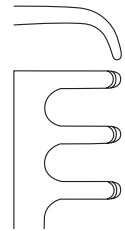

1:1

stumpf, blunt  
170-723-100



**Alm**

4 x 4 Zähne  
4 x 4 teeth

7.0 cm, 2 3/4"

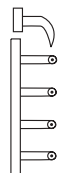

1:1

scharf  
sharp

170-714-070

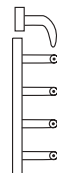

1:1

halbscharf  
semisharp

170-716-070

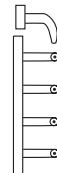

1:1

stumpf  
blunt

170-715-070

10.0 cm, 4"

170-714-100

170-716-100

170-715-100



1:1

**Allport**

4 x 4 Zähne, teeth  
9.5 cm, 3 3/4"

170-719-095





**Scalp-Contour**  
3 x 4 Zähne, teeth  
14.0 cm, 5 1/2"  
scharf, sharp  
170-725-140  
stumpf, blunt  
170-727-140



**Adson-Baby**  
3 x 4 Zähne, teeth  
16.0 cm, 6 1/4"  
scharf, sharp  
170-728-160  
stumpf, blunt  
170-729-160



Adson	Zähne teeth	scharf sharp	stumpf blunt
26.5 cm, 10 1/2"	3 x 4	170-730-265	170-731-265
27.0 cm, 10 5/8"	5 x 6	170-732-265	170-733-265



**Anderson-Adson**  
4 x 4 Zähne, teeth  
20.0 cm, 8"  
scharf, sharp  
170-732-200  
stumpf, blunt  
170-733-200

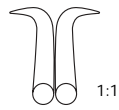

**Mollison**  
4 x 4 Zähne, teeth  
15.5 cm, 6"  
scharf, sharp  
170-754-155

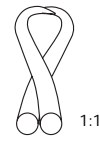

3 x 4 Zähne, teeth

Wullstein	scharf sharp	stumpf blunt
10.5 cm, 4 1/8"	170-742-105	170-743-105
13.0 cm, 5"	170-742-130	170-743-130
15.0 cm, 6"	170-742-150	170-743-150
18.0 cm, 7"	170-742-180	170-743-180



**Schuhknecht**  
3 x 4 Zähne, teeth  
12.5 cm, 5"  
scharf, sharp  
170-758-125  
stumpf, blunt  
170-759-125

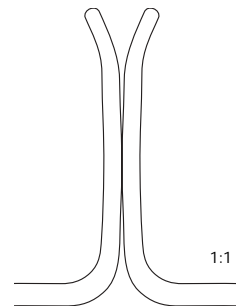

**Mayo-Adams**  
16.5 cm, 6 1/2"  
170-812-165



scharf, sharp  
170-748-105  
stumpf, blunt  
170-749-105

**Weitlaner-Loktite**  
2 x 3 Zähne, teeth  
10.5 cm, 4 1/8"

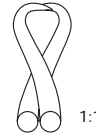

13.0 cm, 5"  
scharf, sharp  
170-750-130  
stumpf, blunt  
170-751-130

**Weitlaner**  
3 x 4 Zähne, teeth

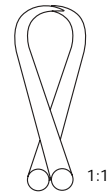

16.5 cm, 6 1/2"  
scharf, sharp  
170-750-165  
stumpf, blunt  
170-751-165

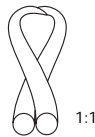

scharf, sharp  
170-752-130  
stumpf, blunt  
170-753-130

**Weitlaner-Wullstein**  
3 x 3 Zähne, teeth  
13.0 cm, 5"

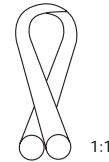

20.0 cm, 8"  
scharf, sharp  
170-734-200  
stumpf, blunt  
170-735-200

**Weitlaner**  
3 x 4 Zähne, teeth

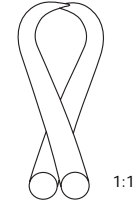

24.0 cm, 9 1/2"  
scharf, sharp  
170-734-240  
stumpf, blunt  
170-735-240



**Plester**  
2 x 2 Zähne, teeth  
13.0 cm, 5"



1:1

scharf, sharp  
170-763-130  
stumpf, blunt  
170-762-130



**Plester**  
2 Zähne, teeth  
stumpf, blunt  
11.0 cm, 4 3/8"  
170-761-110

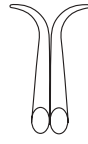

1:1



**Plester**  
2 Zähne, teeth  
stumpf, blunt  
11.0 cm, 4 3/8"  
170-760-110

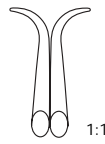

1:1



**Milligan**  
3 x 3 Zähne, teeth  
13.0 cm, 5"  
170-768-130

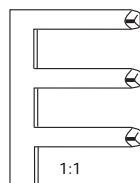

1:1

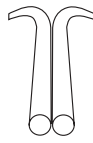

**Weitlaner-Baby**  
13.0 cm, 5"  
170-767-130

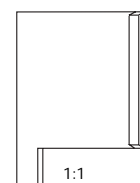

1:1

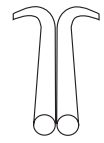



scharf, sharp  
20.0 cm, 8"  
170-795-200

26.0 cm, 10 1/4"  
170-795-260

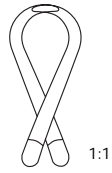

stumpf, blunt  
20.0 cm, 8"  
170-794-200

26.0 cm, 10 1/4"  
170-794-260

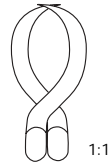

scharf, sharp  
170-786-001

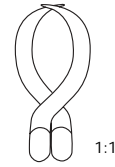

stumpf, blunt  
170-786-000



**Adson**  
3 x 4 Zähne, teeth



**Beckmann-Adson**  
4 x 4 Zähne, teeth  
31.0 cm, 12 1/4"

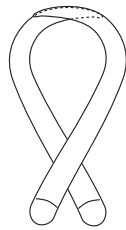

1:1

**Beckmann**  
4 x 4 Zähne, teeth  
scharf, sharp  
31.0 cm, 12 1/4"  
170-786-310

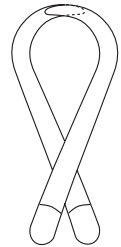

1:1

**Adson**  
4 x 5 Zähne, teeth  
stumpf, blunt  
32.0 cm, 12 1/2"  
170-784-320

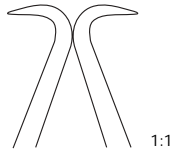

**Gelpi**  
13.5 cm, 5 3/8"  
170-802-135

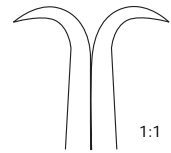

**Gelpi**  
18.0 cm, 7"  
170-802-180

Femur Wundsperrer  
Femur retractor

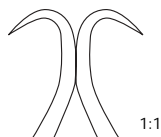

**De Bakey**  
10.0 cm, 4"  
170-745-100  
17.0 cm, 6 3/4"  
170-745-170

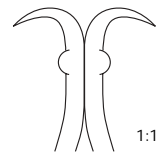

**Gelpi-Loktite**  
18.0 cm, 7"  
170-803-180



**Norfolk and Norwich**  
4 x 5 Zähne, teeth  
stumpf, blunt  
22.0 cm, 8 5/8"  
170-776-220

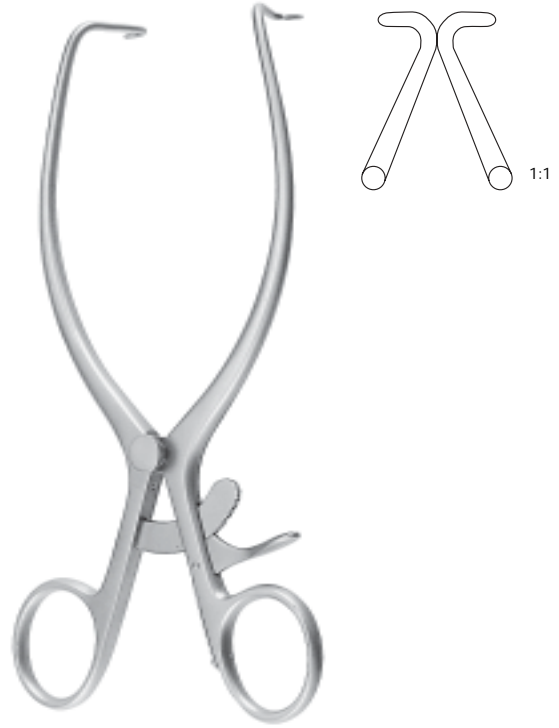

**Jackson Burrows**  
stumpf, blunt  
17.5 cm, 7"  
170-776-175



**Richter**  
17.0 cm, 6 3/4"  
170-778-170



**Joll (Friedman)**  
15.5 cm, 6"  
440-500-000





**Henley**  
16.0 cm, 6 1/4"  
scharf, sharp  
170-769-160  
stumpf, blunt  
170-770-160

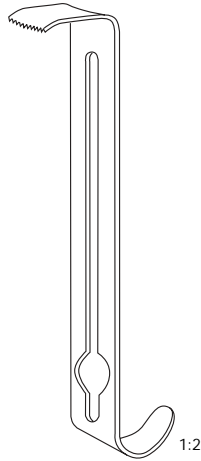

19 x 16 mm  
170-771-001

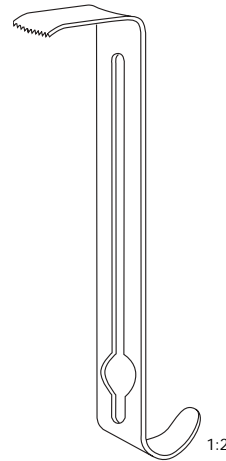

25 x 16 mm  
170-771-002

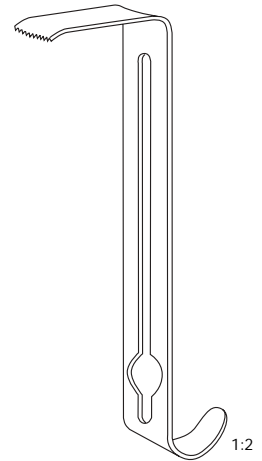

32 x 16 mm  
170-771-003



**Mayo-Adams**  
17.0 cm, 6 3/4"  
170-815-170

30 x 44 mm



**Collin-Baby**  
18.0 cm, 7"  
170-819-000

23 x 44 mm

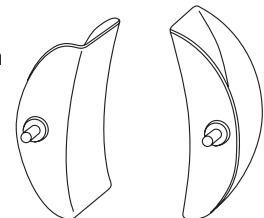

Kugelschnellverschluß  
Ball Snap Closure

mit 2 Paar Valven  
with 2 pairs of blades



Kugelschnellverschluß  
Ball Snap Closure

Seitenvalven  
Lateral blades

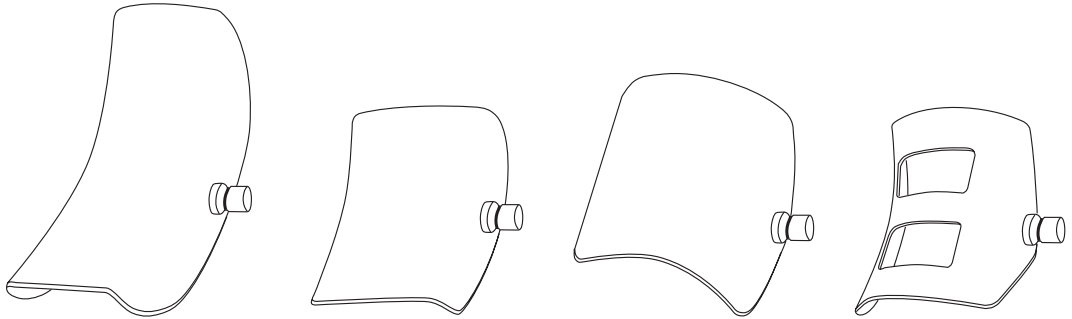

38 x 62 mm	170-839-038			
40 x 80 mm	170-839-040			
50 x 58 mm			170-829-050	
60 x 80 mm	170-839-060	170-832-060	170-829-060	170-834-060
72 x 85 mm			170-829-070	

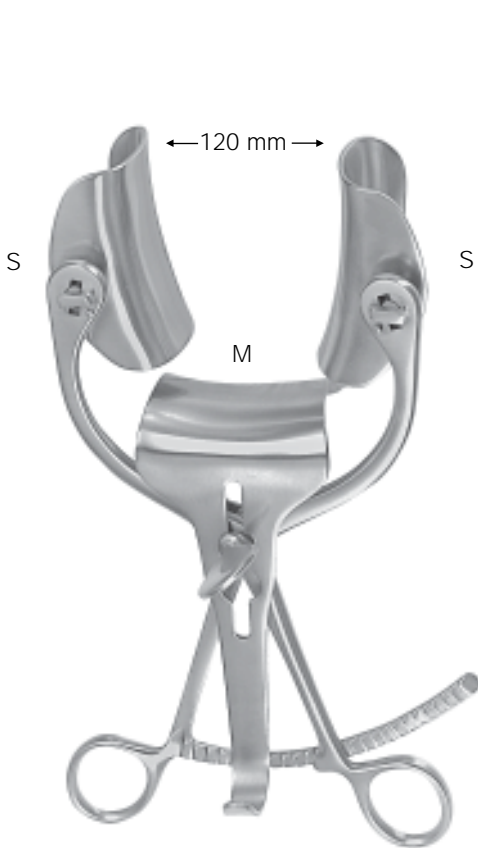

**Collin**  
komplett, complete

S	M	
38 x 62 mm	55 x 55 mm	170-823-000
40 x 80 mm	55 x 65 mm	170-824-000
60 x 80 mm	60 x 75 mm	170-825-000



**Ricard**  
komplett, complete

S	M	C	
72 x 85 mm	80 x 90 mm	28.0 cm	170-827-000
60 x 80 mm	55 x 70 mm	30.0 cm	170-829-000



**Robin-Masse**  
komplett, complete  
170-835-000



**Gosset**  
170-818-100

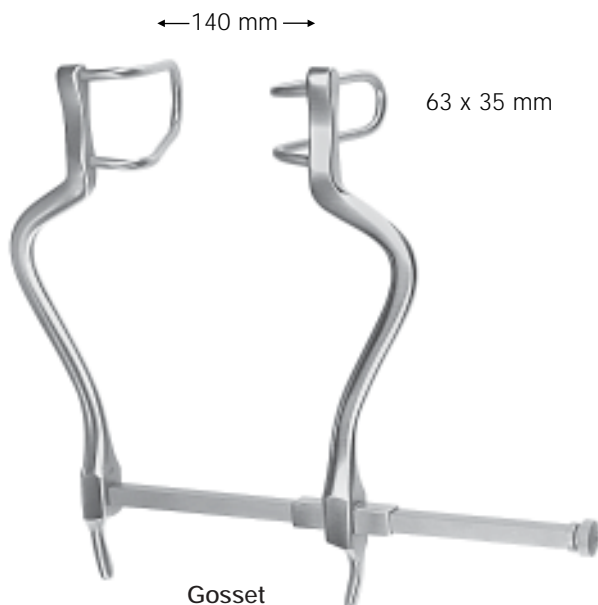

**Gosset**  
170-818-140

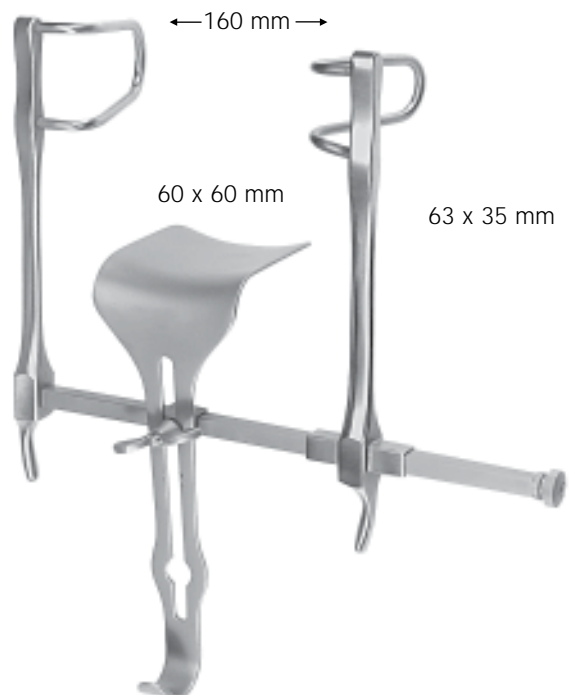

**Gosset**  
170-818-160

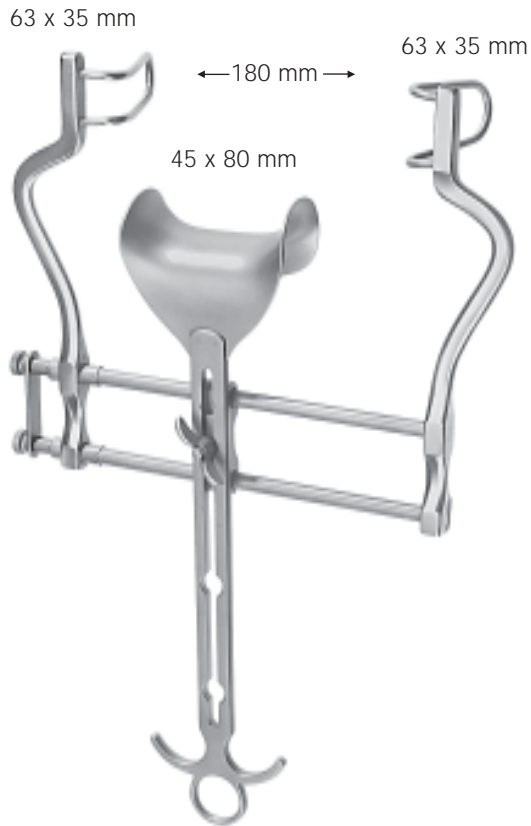

**Balfour**  
170-852-000



**Balfour**  
C  
20.0 cm, 8" 170-856-000  
25.0 cm, 9 3/4" 170-840-000

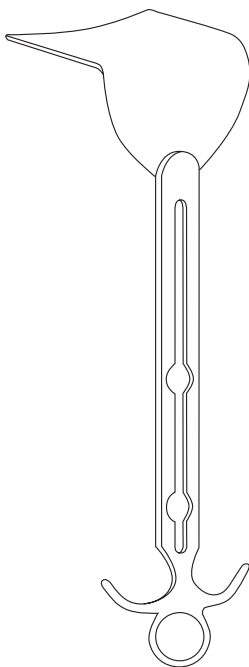

100 x 70 mm  
170-841-010

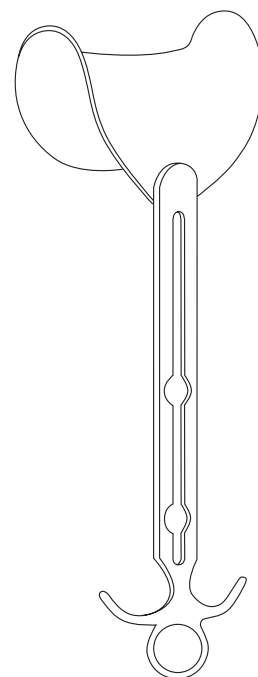

**Balfour**  
45 x 80 mm 170-841-001  
70 x 85 mm 170-841-002  
80 x 90 mm 170-841-003

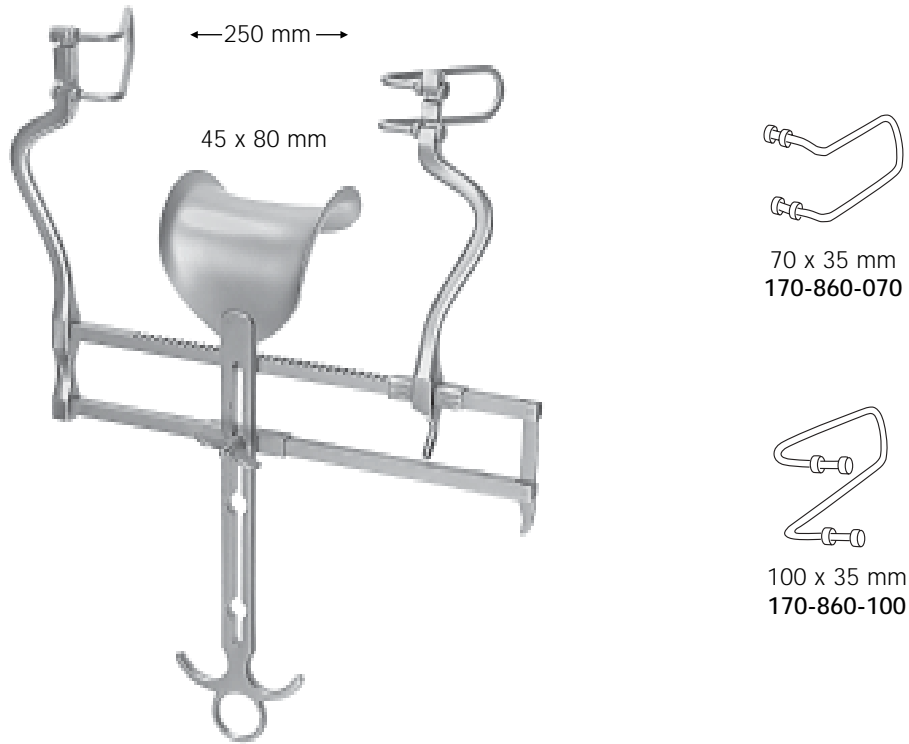

**Balfour US-Type**  
komplett mit 2 Paar Valven  
Complete with 2 pairs of blades  
170-860-000

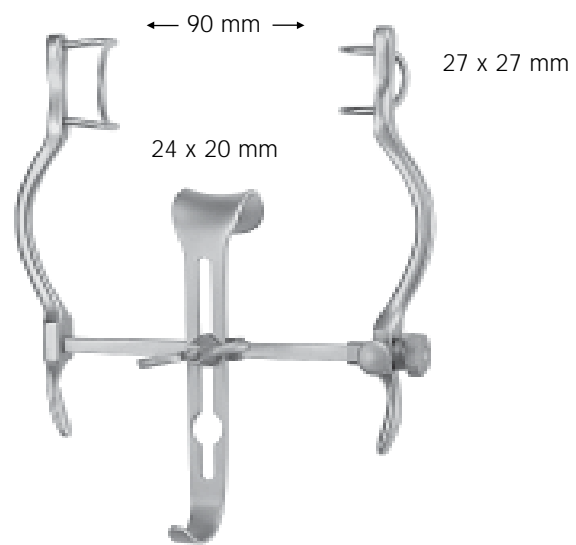

**Balfour-Baby**  
170-766-090



**Abadie**  
3 x 4 Zähne, teeth  
Spreizweite, opening 11.5 cm, 4 1/2"  
170-862-000

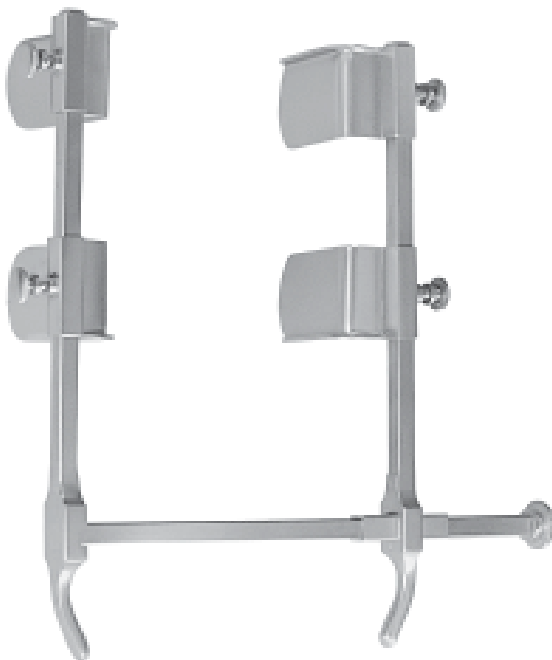

**Berkeley**  
Seitliche Valven 35 x 60mm  
Lateral blades 35 x 60mm  
170-864-000

Mittelvalven  
Central blades

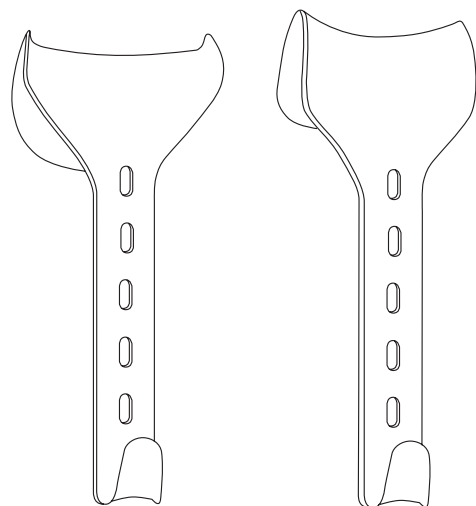

60 x 38 mm  
170-864-038

64 x 51 mm  
170-864-051



Turner Warwick Bauchdeckenhalter  
Turner Warwick Abdominal Retractor Set

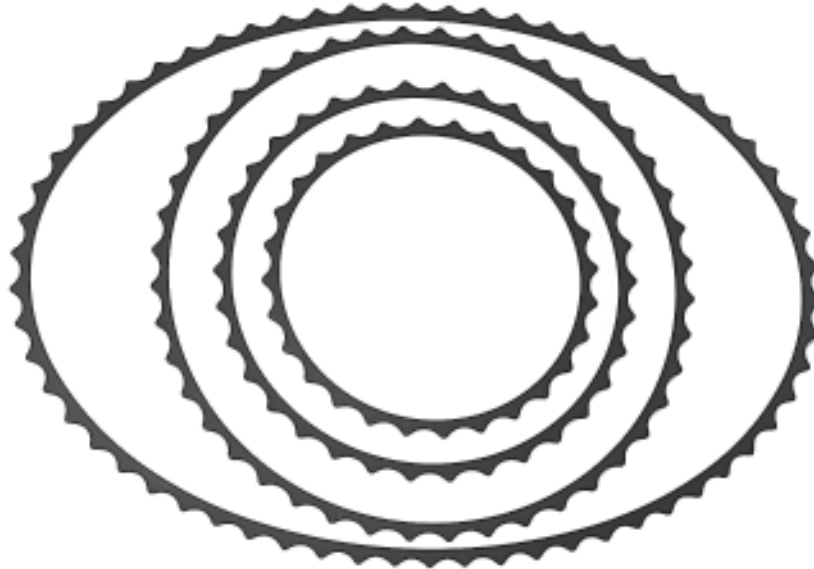

Rahmen, geschwärzt  
frames, black finish

ø 18.0 cm, 7"	170-900-001
ø 23.0 cm, 9"	170-900-002
ø 30.5 cm, 12"	170-900-003
oval 45.5 x 33.0 cm, 17 3/4" x 13"	170-900-004

Valven  
Blades



Valve gebogen, geschwärzt  
blade curved, black finish

1 Zahn, 13 mm tief  
single hook, 13 mm deep  
**170-900-009**

51 x 38 mm  
**170-900-010**

76 x 60 mm  
**170-900-011**



Valve gebogen, geschwärzt  
blade curved, black finish

114 x 60 mm  
**170-900-015**

89 x 60 mm  
**170-900-016**



Valve aus Kupfer, geschwärzter Schaft  
copper on black

19 x 76 mm  
**170-900-020**

38 x 102 mm  
**170-900-021**

57 x 89 mm  
**170-900-022**

57 x 114 mm  
**170-900-023**

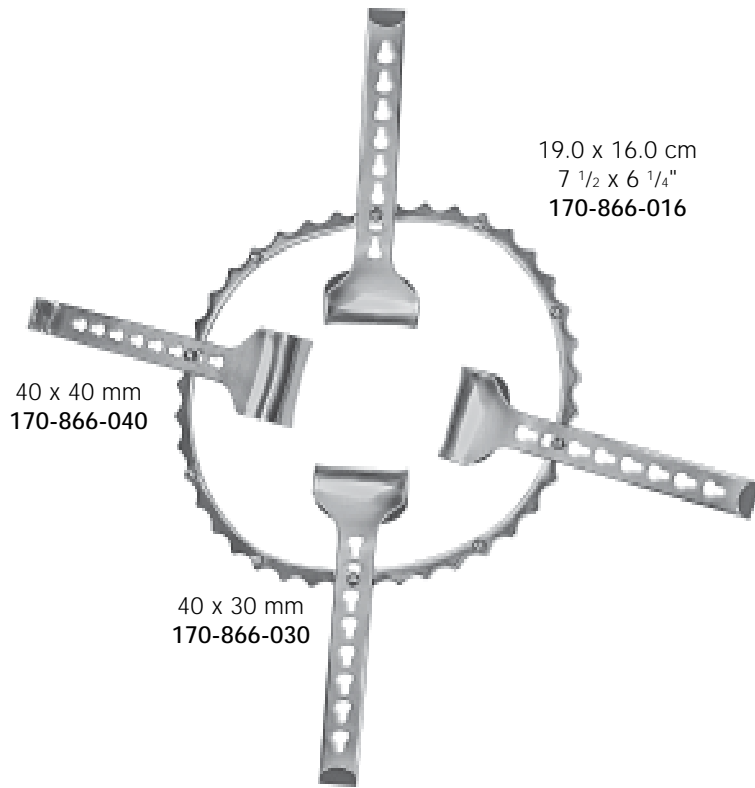

19.0 x 16.0 cm  
7 1/2 x 6 1/4"  
170-866-016

40 x 40 mm  
170-866-040

40 x 30 mm  
170-866-030

**Denis-Browne**  
komplett, incl. 4 Valven  
complete, incl. 4 blades  
170-866-000



80 x 45 mm

110 x 70 mm

**O-Sullivan-O'Connor**  
komplett, complete  
170-868-000



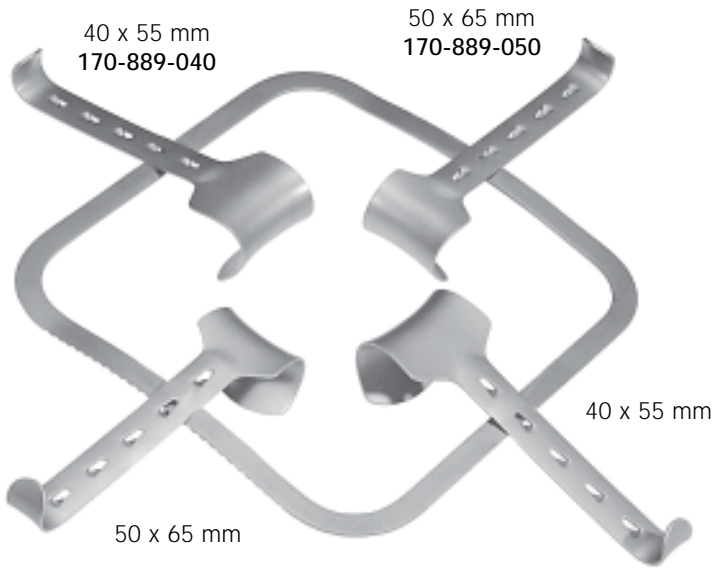

**Kirschner**  
komplettes Set, complete set  
170-884-000

Rahmen allein, frame only  
24.0 x 24.0 cm, 9 1/2" x 9 1/2"  
170-884-024

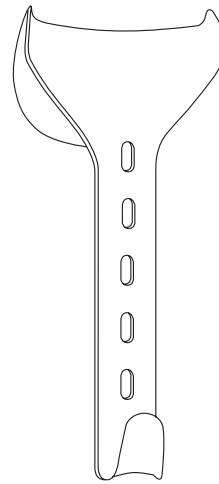

78 x 65 mm  
170-889-075

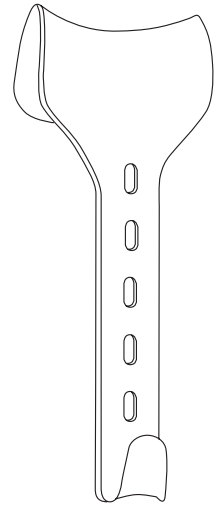

80 x 90 mm  
170-889-086

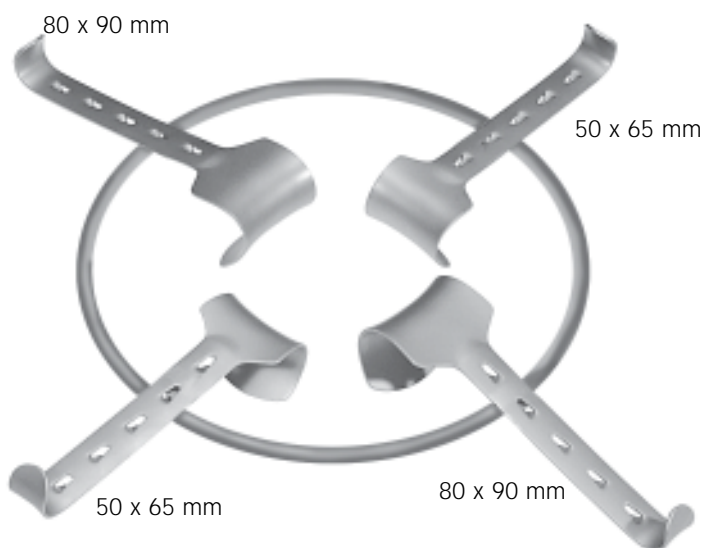

**Semm**  
komplettes Set, complete Set  
170-882-000

Rahmen allein, frame only  
27.5 x 25.0 cm, 10 3/4" x 9 3/4"  
170-882-030

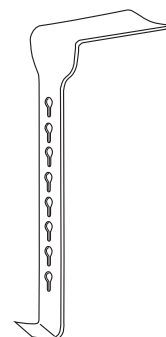

98 x 52 mm  
170-889-098

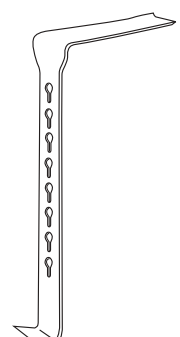

105 x 35 mm  
170-889-099



Kugelschnellverschluß  
Ball Snap Closure

38 x 60 mm  
170-894-004

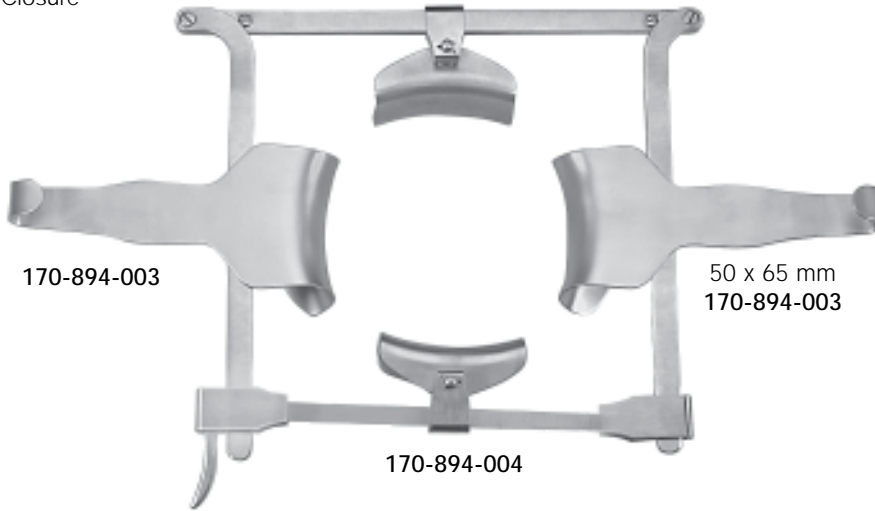

170-894-003

50 x 65 mm  
170-894-003

170-894-004

**Franz**  
komplettes Set, complete set  
170-894-000

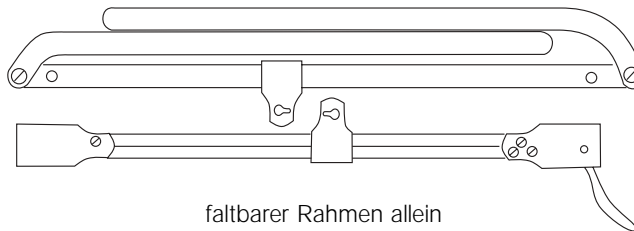

faltbarer Rahmen allein  
foldable frame only  
30.0 x 30.0 cm, 11 3/4" x 11 3/4"  
170-894-300

Valven  
Blades

45 x 80 mm  
170-894-002

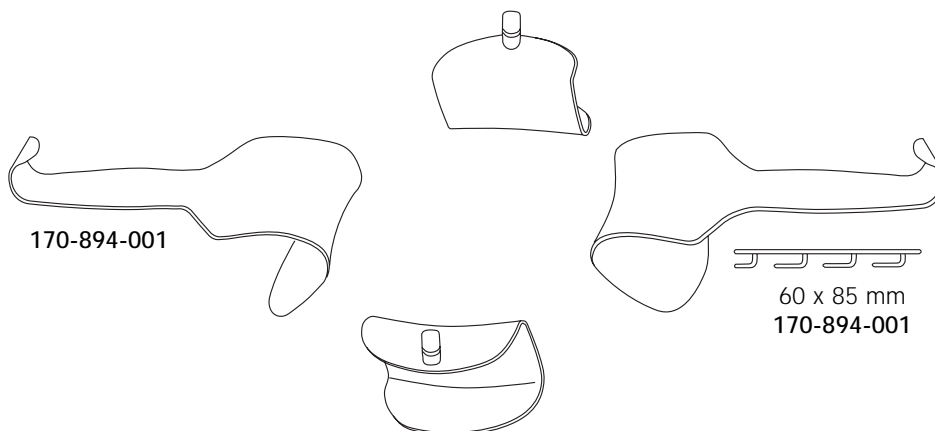

170-894-001

60 x 85 mm  
170-894-001

170-894-002



**Doyen**  
28.0 cm, 11"

95 x 60 mm	<b>170-879-001</b>
105 x 65 mm	<b>170-879-002</b>
115 x 65 mm	<b>170-879-003</b>
125 x 65 mm	<b>170-879-004</b>



Kette mit Gewicht  
chain with weight  
78.5cm, 31"  
645 g  
**170-880-100**



**Rochard**  
28.0 cm, 11"

95 x 48 mm	<b>170-950-090</b>
105 x 48 mm	<b>170-950-105</b>
115 x 48 mm	<b>170-950-115</b>
125 x 48 mm	<b>170-950-125</b>
155 x 48 mm	<b>170-950-155</b>



**Rochard**  
Haltevorrichtung,  
fixation device  
19.0 cm, 7 1/2"  
**170-950-050**



**Rochard**  
Montagerahmen für eine Seite  
mounting frame for one side  
**170-950-000**



**Rochard**  
Montagerahmen für zwei Seiten  
mounting frame for two sides  
**170-950-100**

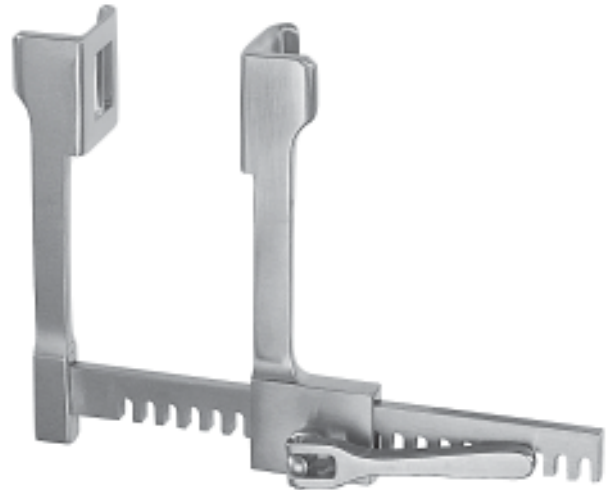
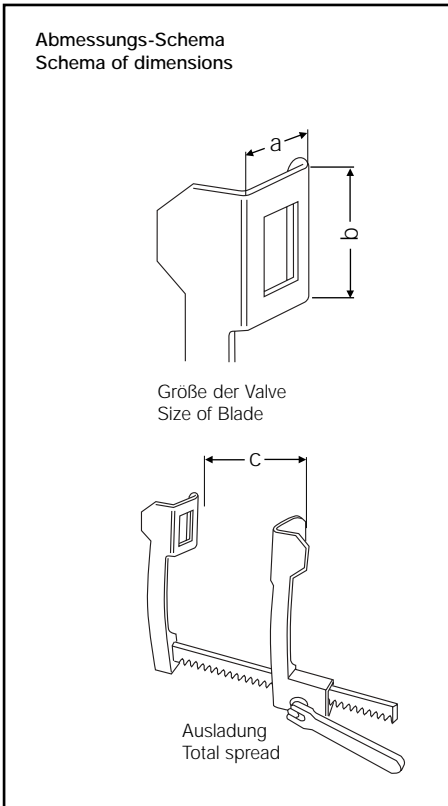

**Finocchetto-Baby**

a	b	c	
18 mm	20 mm	75 mm	290-177-075

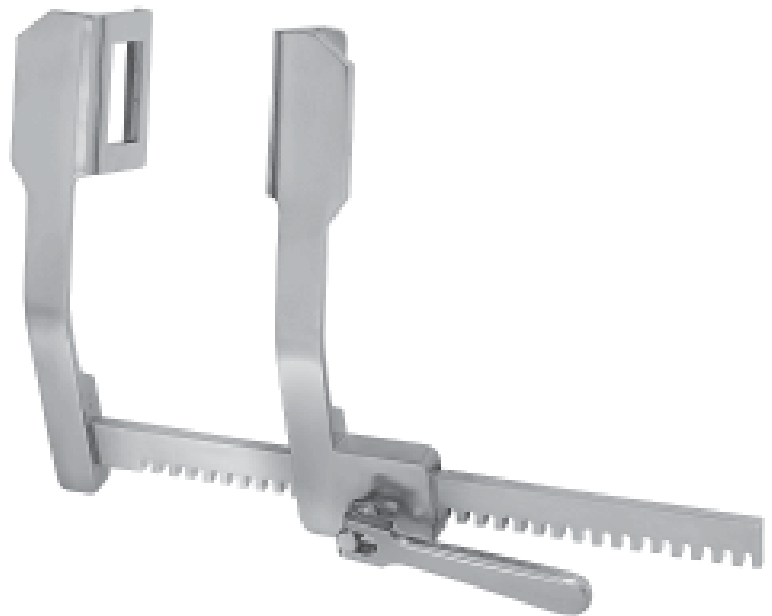

**Finocchetto**

a	b	c	
40 mm	40 mm	165 mm	290-178-165
45 mm	65 mm	200 mm	290-178-200
70 mm	65 mm	250 mm	290-178-250



**Tuffier**

a	b	c	
50 mm	45 mm	165 mm	290-174-000



**Ribbon**

biegsam, malleable

200 x 6 mm 170-973-006

200 x 12 mm 170-973-012

200 x 17 mm 170-973-017

200 x 20 mm 170-973-020

250 x 25 mm 170-973-025



**Ribbon**

biegsam, malleable

330 x 13 mm 170-963-013

330 x 25 mm 170-963-025

330 x 32 mm 170-963-032

330 x 40 mm 170-963-040

330 x 50 mm 170-963-050



**Tuffier**

biegsam, malleable

200 x 25/17 mm

170-975-250



**Haberer**

biegsam, malleable

280 x 25/30 mm 170-971-250

300 x 37/45 mm 170-971-300

300 x 40/50 mm 170-971-370

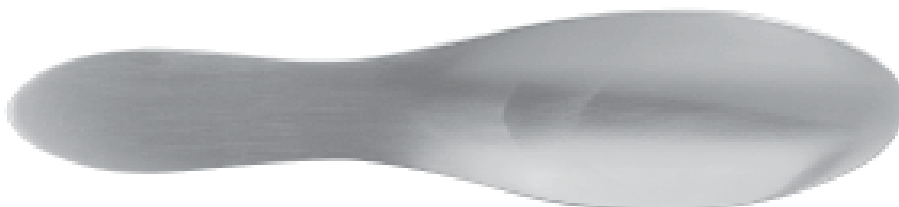

**Reverdin**

280 x 45/60 mm

170-953-280



Vorteile der RZ-Medizintechnik Nadel:

- Für die Herstellung von RZ Nadeln werden nur hochwertige Materialien verwendet.
- Eine hochglanzpolierte Fläche verleiht der Nadel eine bessere Gleitfähigkeit und verringert dadurch die Traumatisierung.
- Der Durchmesser der Nadel ist so ausgelegt, daß nur eine minimale Perforation des Gewebes stattfindet. Hierdurch wird eine bessere Heilung erfolgen.

Advantages of RZ-Medizintechnik needles:

- For the production of RZ needles only high quality materials will be used.
- A mirror finish surface gives the needle a better slide and reduces any trauma.
- The diameter of the needle is kept to a minimum, allowing a minimum of perforation. Thus assisting the healing process.

in Packungen zu 12 Nadeln  
in packages of 12 needles



Federrohr  
spring eye

- 1: 180-010-001
- 2: 180-010-002
- 3: 180-010-003
- 4: 180-010-004
- 5: 180-010-005
- 6: 180-010-006
- 7: 180-010-007
- 8: 180-010-008
- 9: 180-010-009
- 10: 180-010-010
- 11: 180-010-011
- 12: 180-010-012
- 13: 180-010-013
- 14: 180-010-014
- 15: 180-010-015
- 16: 180-010-016

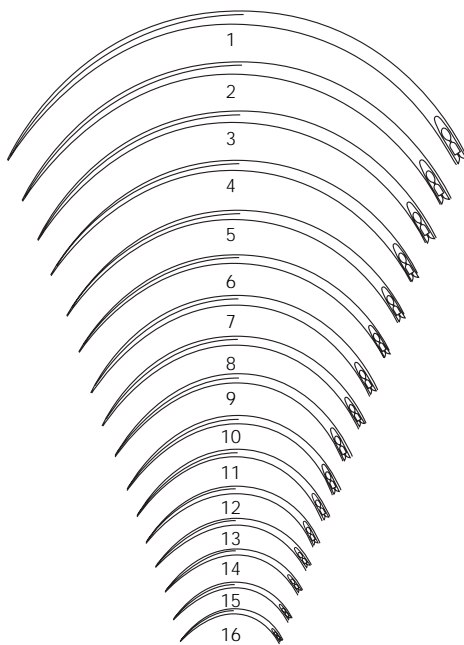

Federrohr  
spring eye

- 1: 180-012-001
- 2: 180-012-002
- 3: 180-012-003
- 4: 180-012-004
- 5: 180-012-005
- 6: 180-012-006
- 7: 180-012-007
- 8: 180-012-008
- 9: 180-012-009
- 10: 180-012-010
- 11: 180-012-011
- 12: 180-012-012
- 13: 180-012-013
- 14: 180-012-014
- 15: 180-012-015
- 16: 180-012-016

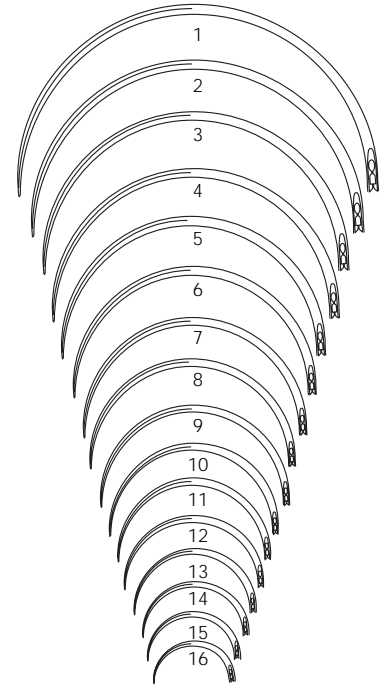

Die folgenden Nadeln sind alle für die Haut- und Muskelnaht bestimmt.  
Es handelt sich um schneidende oder Rundkörpernadeln.

The following suture needles are basically used for muscular and skin suture. They are either cutting or roundbody needles.



Federrohr  
spring eye

- 000: 180-018-030
- 00: 180-018-020
- 0: 180-018-010
- 1: 180-018-001
- 2: 180-018-002
- 3: 180-018-003
- 4: 180-018-004
- 5: 180-018-005
- 6: 180-018-006

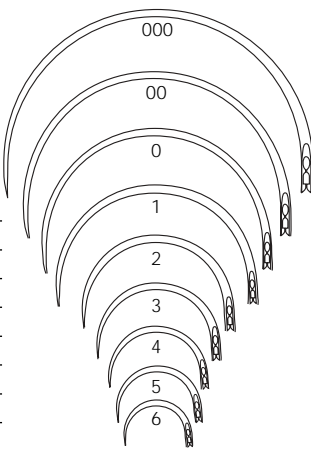

Federrohr  
spring eye

- 1: 180-020-001
- 2: 180-020-002
- 3: 180-020-003
- 4: 180-020-004
- 5: 180-020-005
- 6: 180-020-006

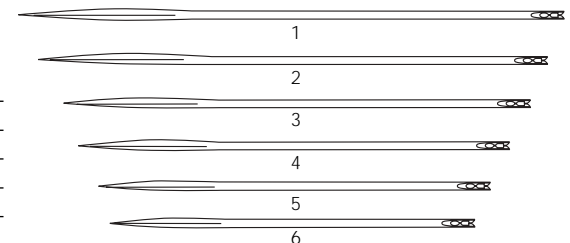



Die folgenden Nadeln sind für die Gefäß- und Augennaht bestimmt. Es handelt sich um Rundkörperringeln oder Rundkörperringeln mit Trokarspitze.

The following suture needles are basically used for vein and eye suture. They are either roundbody or roundbody needles with trocar tip.

 Δ Ob

Federöhr  
spring eye

- 0: 180-030-010
- 1: 180-030-001
- 2: 180-030-002
- 3: 180-030-003
- 4: 180-030-004
- 5: 180-030-005

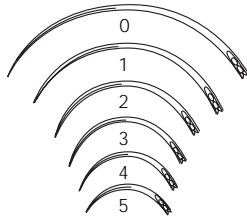

 Δ Og

Federöhr  
spring eye

- 0: 180-032-010
- 1: 180-032-001
- 2: 180-032-002
- 3: 180-032-003
- 4: 180-032-004
- 5: 180-032-005

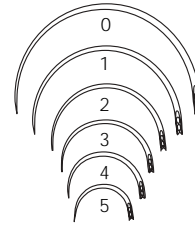

 ○ Kalt

geschlossenes Öhr  
plain eye

- 00: 180-036-020
- 0: 180-036-010
- 1: 180-036-001
- 2: 180-036-002
- 3: 180-036-003

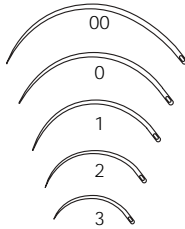

 ○ Payr

geschlossenes Öhr  
plain eye

- 00: 180-040-020
- 0: 180-040-010
- 1: 180-040-001
- 2: 180-040-002
- 3: 180-040-003

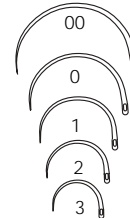

Die Nadeln Fig. Pb, Pc sind speziell für die Darmnaht bestimmt. Es handelt sich hierbei um Rundkörperringeln.

The needles Fig. Pb, Pc are specially designed for intestinal suture. They are always roundbody needles.

 ○ Pb

Federöhr  
spring eye

- 00: 180-024-020
- 0: 180-024-010
- 1: 180-024-001
- 2: 180-024-002
- 3: 180-024-003
- 4: 180-024-004
- 5: 180-024-005

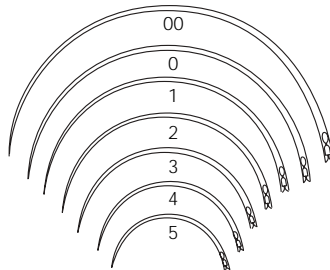

 ○ Pc

Federöhr  
spring eye

- 00: 180-022-020
- 0: 180-022-010
- 1: 180-022-001
- 2: 180-022-002
- 3: 180-022-003
- 4: 180-022-004
- 5: 180-022-005
- 6: 180-022-006
- 7: 180-022-007
- 8: 180-022-008

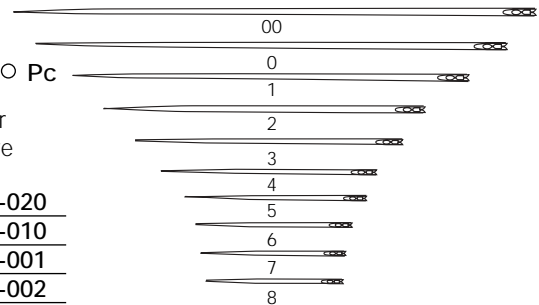

Weitere Nadelmodelle, sowie Mikro Nahtmaterial sind auf Anfrage erhältlich. Alle Nadeln können auch steril geliefert werden.

Further needle patterns and mikro suture material are available on request. All suture needles can be delivered also steril.



10

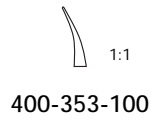
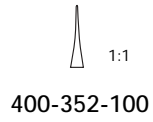

**Barraquer-Troutman**  
10.0 cm, 4"

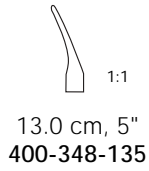

**Barraquer**



**Barraquer**  
13.5 cm, 5 <sup>3</sup>/<sub>8</sub>"  
400-350-135

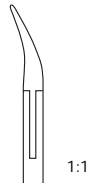
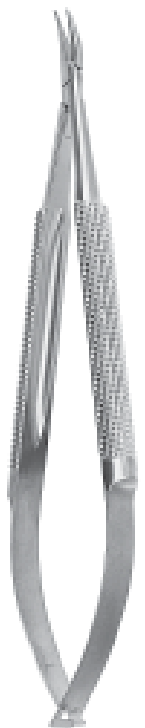

**Gomel**  
14.0cm, 5 1/2"  
250-064-140

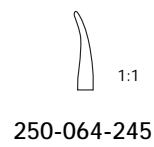
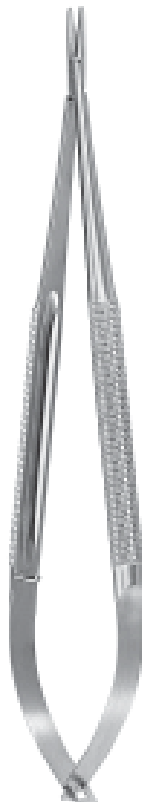

ohne Sperre, without catch  
18.5 cm, 7 1/4"

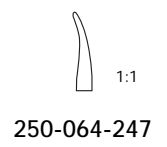

mit Sperre, with catch  
18.5 cm, 7 1/4"





**Castroviejo**  
mit Sperre, with catch  
14.5 cm, 5 3/4"

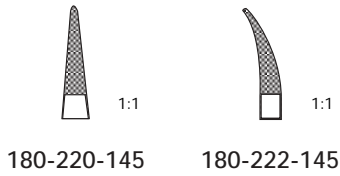
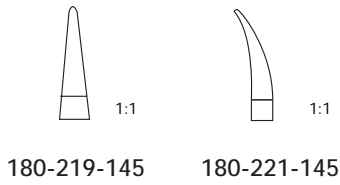

**Castroviejo**  
mit Sperre, with catch  
18.0 cm, 7"

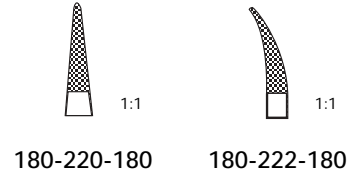
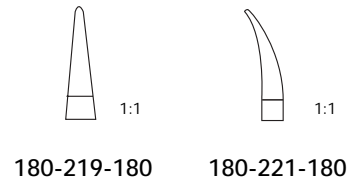

Spezielle Nadelhalter für Mikro- und Gefäßchirurgie  
Special needle holders for micro- and vessel surgery



Flachgriff, flat handle 8 mm  
14.0 cm, 5 1/2"  
Spitze, tip 0.4 mm



Rundgriff, round handle 10 mm  
13.0 cm, 5"  
Spitze, tip 0.5 mm



Rundgriff, round handle 8 mm  
13.0 cm, 5"  
Spitze, tip 0.4 mm

gerade, ohne Sperre straight, without catch	<b>250-064-149</b>		
gebogen, ohne Sperre curved, without catch	<b>250-064-150</b>	<b>250-064-146</b>	<b>250-064-148</b>
gebogen, mit Sperre curved, with catch	<b>250-064-151</b>	<b>250-064-145</b>	<b>250-064-147</b>

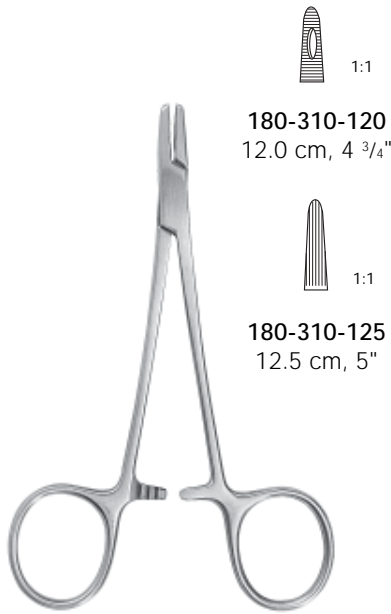

Derf



Collier  
12.5 cm, 5"  
180-314-125



Webster  
13.0 cm, 5"  
180-318-130

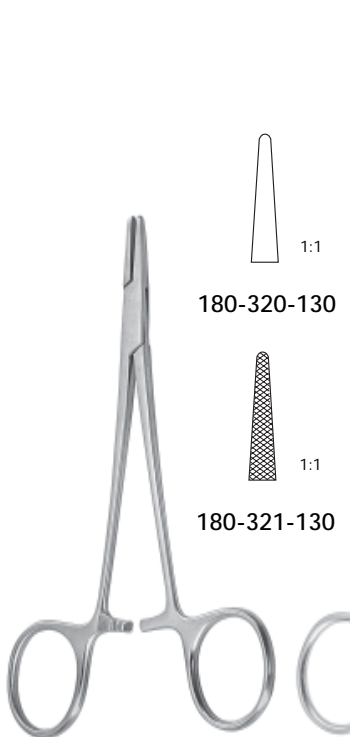

Halsey  
13.0 cm, 5"

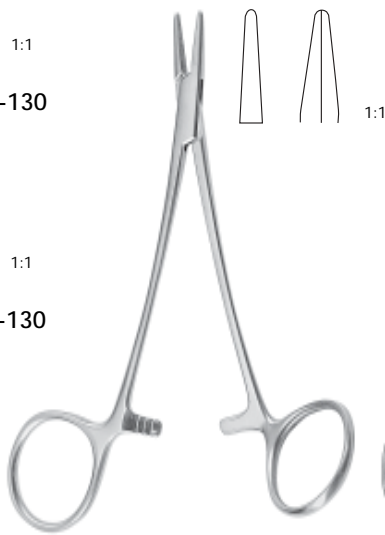

Neivert  
13.0 cm, 5"  
180-322-130



Hegar-Baumgartner  
14.0 cm, 5 1/2"  
180-324-140

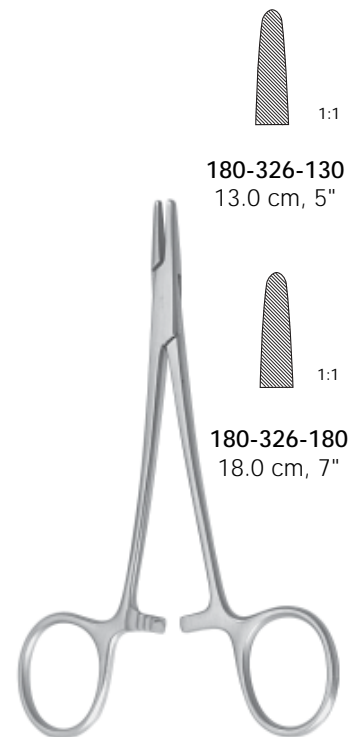

Brown



**Crile-Murray**  
15.0 cm, 6"  
180-330-150

**Crile-Wood**  
15.0 cm, 6"  
180-332-150  
18.0 cm, 7"  
180-332-180

**Adson**  
18.0 cm, 7"  
180-334-180

**Metzenbaum**  
18.0 cm, 7"  
180-336-180

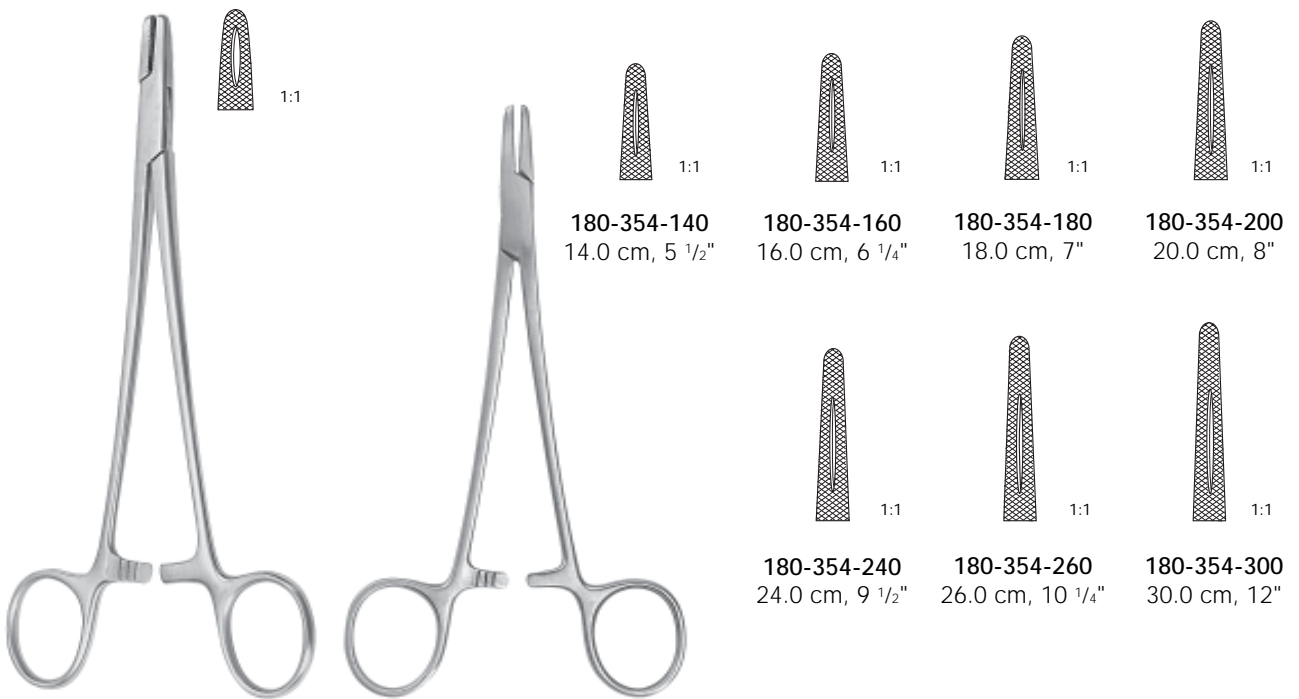

**M.G.H.  
Mass.-General-Hospital**  
17.0 cm, 6 3/4"  
180-330-170

**Mayo-Hegar**

**180-354-140**  
14.0 cm, 5 1/2"

**180-354-160**  
16.0 cm, 6 1/4"

**180-354-180**  
18.0 cm, 7"

**180-354-200**  
20.0 cm, 8"

**180-354-240**  
24.0 cm, 9 1/2"

**180-354-260**  
26.0 cm, 10 1/4"

**180-354-300**  
30.0 cm, 12"



10



180-356-160  
16.0 cm, 6 1/4"

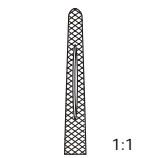
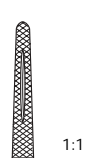

180-356-180  
18.0 cm, 7"

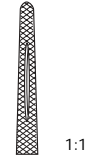

180-356-200  
20.0 cm, 8"

**Mayo-Hegar**  
Schlankes Modell  
delicate pattern



**Lawrence**  
15.0 cm, 6"  
180-381-150



**Heaney**  
21.0 cm, 8 1/4"  
180-361-210

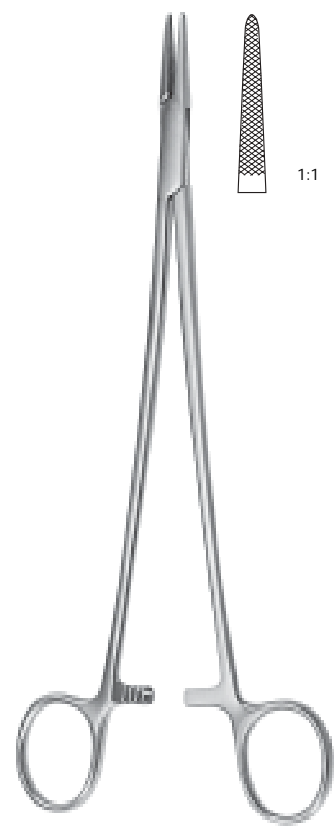
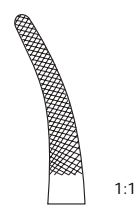

**Jamison**  
23.5 cm, 9 1/4"  
180-362-235

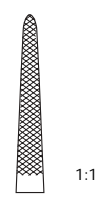

**Masson**  
27.0 cm, 10 1/2"  
180-364-270

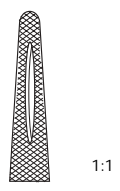



**Finocchietto**  
27.0 cm, 10 5/8"  
180-367-270



**Wangensteen**  
27.0 cm, 10 5/8"  
180-370-270

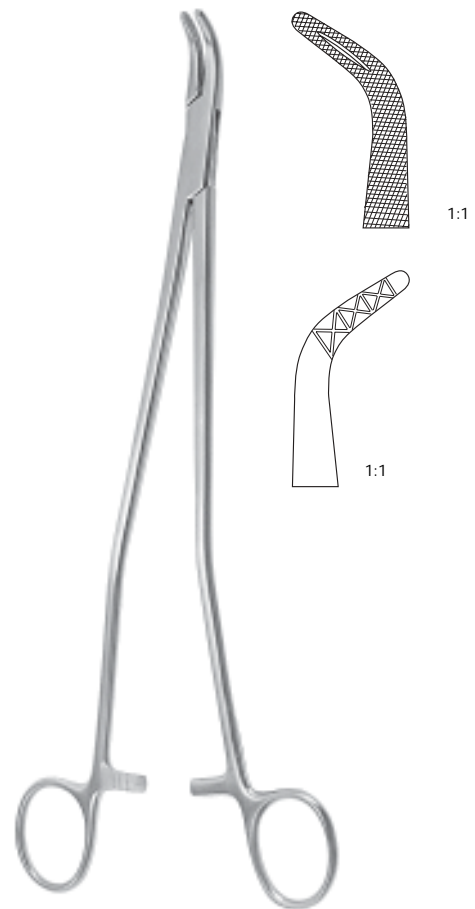

**Johnson**  
27.0 cm, 10 5/8"  
180-374-270



10

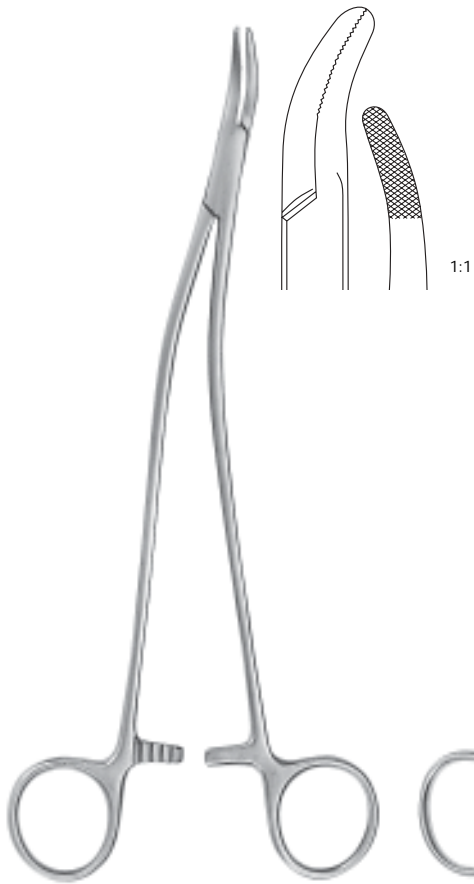

**Stratte**  
23.0 cm, 9"  
180-377-230

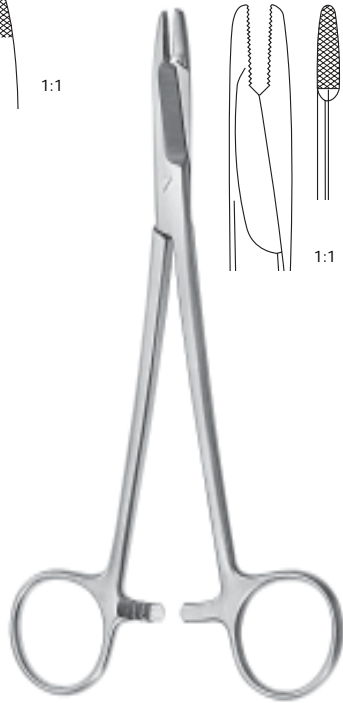

**Olsen-Hegar**  
17.0 cm, 6 3/4"  
180-382-170

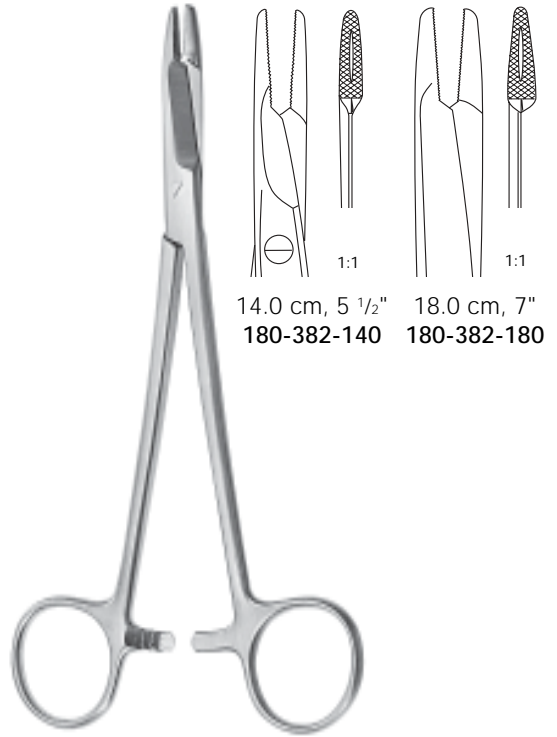

14.0 cm, 5 1/2"  
180-382-140    18.0 cm, 7"  
180-382-180

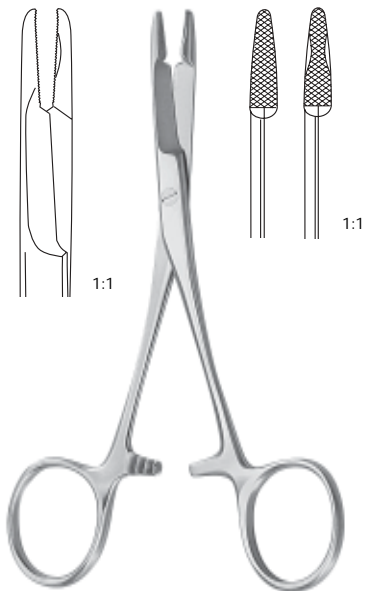

**Olsen-Hegar**  
14.0 cm, 5 1/2"  
180-384-140

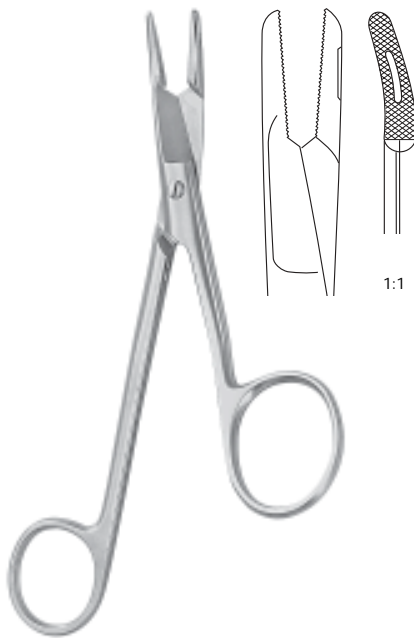



**Gillies**  
16.0 cm, 6 1/4"  
180-389-160



**Toennis**  
18.0 cm, 7"  
180-440-180





Mathieu

-   
 1:1  
 14.0 cm, 5 1/2"  
 180-420-140
-   
 1:1  
 17.0 cm, 6 3/4"  
 180-420-170
-   
 1:1  
 20.0 cm, 8"  
 180-420-200





Mathieu  
schlanke Maul  
delicate jaw

-   
 1:1  
 14.0 cm, 5 1/2"  
 180-422-140
-   
 1:1  
 17.0 cm, 6 3/4"  
 180-422-170





Mathieu

-   
 1:1  
 17.0 cm, 6 3/4"  
 180-430-170
-   
 1:1  
 20.0 cm, 8"  
 180-430-200



Mathieu-Kocher

-   
 1:1  
 14.0 cm, 6 1/4"  
 180-425-140
-   
 1:1  
 17.0 cm, 6 3/4"  
 180-425-170
-   
 1:1  
 20.0 cm, 8"  
 180-425-200



Lichtenberg  
20.0 cm, 8"  
180-450-200



**Naht**  
Nadelhalter mit Hartmetalleinlagen

**Suture**  
Needle Holder  
with Tungsten Carbide Inserts

10

Je nach Anwendungsgebiet werden unsere TC-Nadelhalter mit den jeweils passenden TC-Einsätzen versehen.

Depending on their usage, our TC-needle holders are equipped with the most suitable TC-inserts.

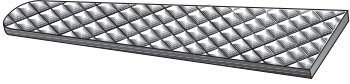

**Normal** 0.5 mm  
für Nadeln und Nahtmaterial bis Stärke 4-0

**Regular** 0.5 mm  
for use with sutures up to size 4-0

**R**

massive Hartmetalleinlagen aus diamantharter Chrom-Wolfram-Legierung garantieren langwährenden sicheren Halt der Nadel.

micro-bonded inserts of solid Tungsten Carbide for longlasting secure hold of suture needle

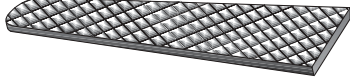

**Fein** 0.4 mm  
für feine Nadeln und Nahtmaterial Stärke 5-0 und 6-0

**Fine** 0.4 mm  
for delicate needles and sutures sizes 5-0 and 6-0

**F**

durchgehend vacuum-gehärtet für gleichbleibende Elastizität und Stabilität

vacuum-hardened throughout for consistent flexibility and alignment



**Extra-Fein** 0.3 mm  
für Mikro-Nadeln und Nahtmaterial bis Stärke 10-0

**Extra-Fine** 0.3 mm  
for use with micro-needles and sutures up to size 10-0

**EF**



**Glatt**  
für feine Nadeln und Nahtmaterial Stärke 7-0 bis 10-0

**Smooth**  
for delicate needles and suture sizes 7-0 thru 10-0

**S**

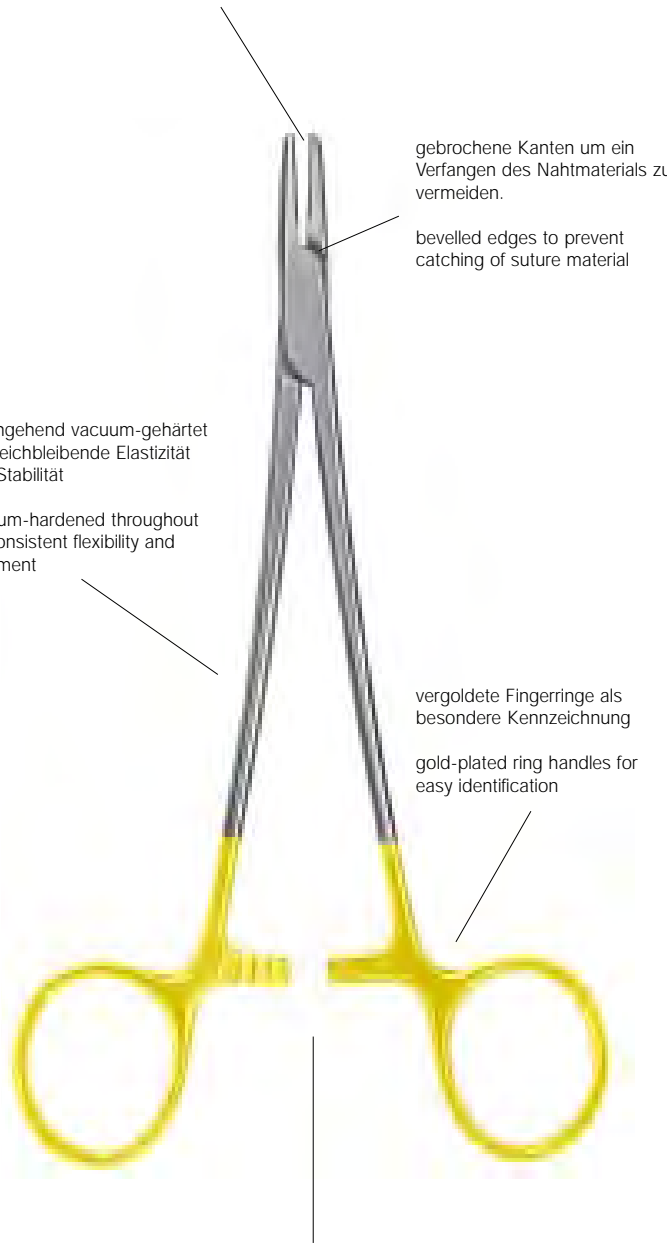

gebrochene Kanten um ein Verfangen des Nahtmaterials zu vermeiden.

bevelled edges to prevent catching of suture material

vergoldete Fingerringe als besondere Kennzeichnung

gold-plated ring handles for easy identification

Präzisionsperre für sicheres Öffnen und Schließen

precision-cut ratchet for safe opening and closing



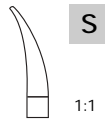
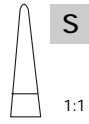

180-519-145

180-521-145

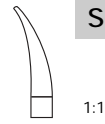
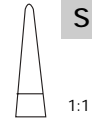

180-519-180

180-521-180

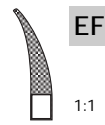
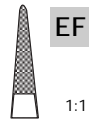

180-520-145

180-522-145



180-520-180

180-522-180

Castroviejo  
mit Sperre, with catch  
14.5 cm, 5 3/4"

Castroviejo  
mit Sperre, with catch  
18.0 cm, 7"

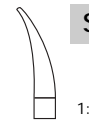
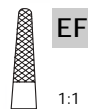
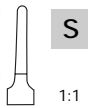
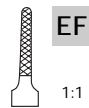

180-510-145

180-511-145

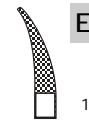
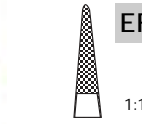

180-512-145

180-513-145

- 16.0 cm, 6 1/2" **180-530-160**
- 18.0 cm, 7" **180-530-180**
- 20.0 cm, 8" **180-530-200**
- 23.0 cm, 9" **180-530-230**
- 26.0 cm, 10 1/4" **180-530-260**

Kalt  
13.5 cm, 5 3/8"  
**180-524-135**

Hepp Scheidel  
18.0 cm, 7"  
**180-512-180**

Barraquer  
14.5 cm, 5 3/4"



10

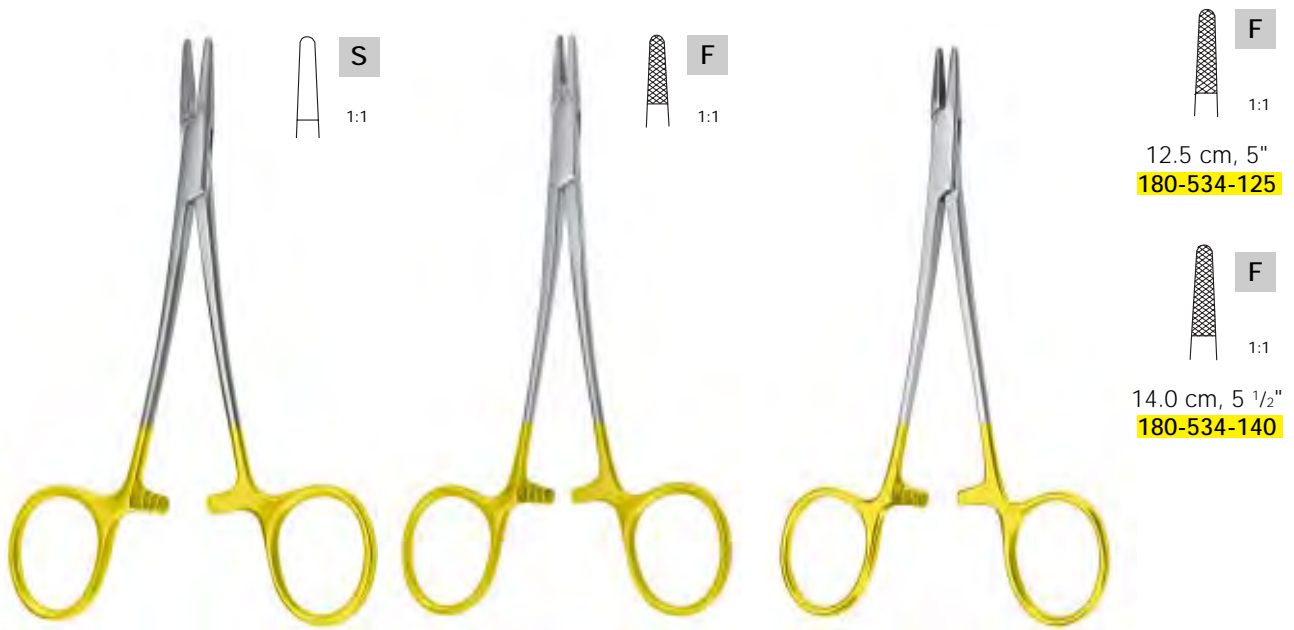

Webster  
13.0 cm, 5"  
180-570-130

Derf  
12.0 cm, 4 3/4"  
180-532-120

Hegar-Baumgartner

F  
1:1  
12.5 cm, 5"  
180-534-125

F  
1:1  
14.0 cm, 5 1/2"  
180-534-140



Halsey  
13.0 cm, 5"



Webster  
13.0 cm, 5"  
180-538-130



Crile-Wood  
15.0 cm, 6"  
180-540-150  
18.0 cm, 7"  
180-540-180



- F** 1:1  
18.0 cm, 7"  
**180-545-180**
- F** 1:1  
20.0 cm, 8"  
**180-545-200**
- F** 1:1  
26.0 cm, 10 1/4"  
**180-545-260**

Sarot



- R** 1:1  
16.0 cm, 6 1/4"  
**180-550-160**
- R** 1:1  
18.0 cm, 7"  
**180-550-180**
- R** 1:1  
20.0 cm, 8"  
**180-550-200**
- R** 1:1  
24.0 cm, 9 1/2"  
**180-550-240**
- R** 1:1  
26.0 cm, 10 1/4"  
**180-550-260**
- R** 1:1  
30.0 cm, 12"  
**180-550-300**

Mayo-Hegar

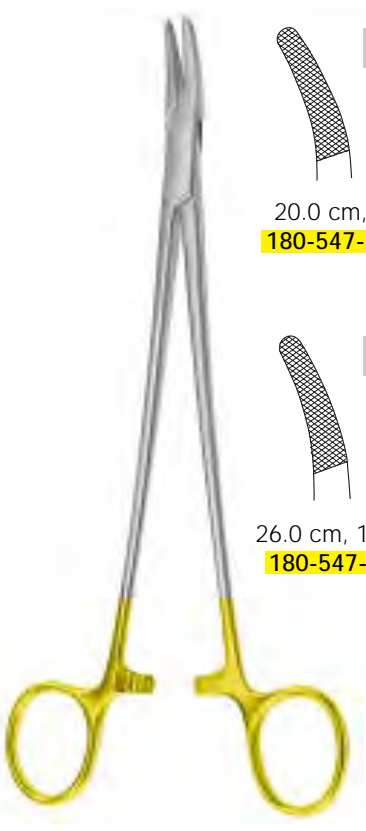

- R** 1:1  
20.0 cm, 8"  
**180-547-200**
- R** 1:1  
24.0 cm, 9 1/4"  
**180-547-240**
- R** 1:1  
26.0 cm, 10 1/4"  
**180-547-260**

Mayo-Hegar (Heaney)



- F** 1:1  
18.0 cm, 7"  
**180-548-180**
- F** 1:1  
20.0 cm, 8"  
**180-548-200**
- F** 1:1  
23.0 cm, 9"  
**180-548-230**
- F** 1:1  
26.0 cm, 10 1/4"  
**180-548-260**
- F** 1:1  
31.0 cm, 12 1/4"  
**180-548-310**
- F** 1:1  
37.0 cm, 14 1/2"  
**180-548-370**

DeBakey



10



Ryder-Vascular



13.0 cm, 5"  
180-561-130

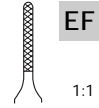

15.0 cm, 6"  
180-561-150

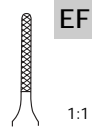

18.0 cm, 7"  
180-561-180

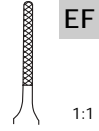

20.0 cm, 8"  
180-561-200

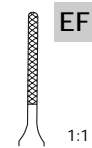

23.0 cm, 9"  
180-561-230

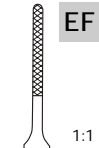

26.0 cm, 10 1/4"  
180-561-260

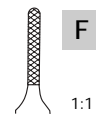

13.0 cm, 5"  
180-560-130

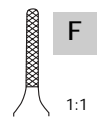

16.0 cm, 6"  
180-560-160

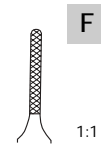

18.0 cm, 7"  
180-560-180

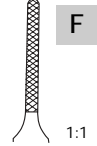

20.0 cm, 8"  
180-560-200

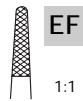

15.0 cm, 6"  
180-555-150

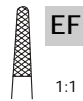

17.0 cm, 6 3/4"  
180-555-170

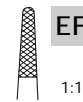

20.0 cm, 8"  
180-555-200

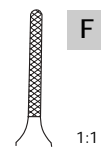

23.0 cm, 9"  
180-560-230

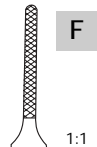

26.0 cm, 10 1/4"  
180-560-260



Ryder



Schwedisches Modell



**Finocchetto**  
27.0 cm, 10 5/8"  
**180-558-270**



**Masson**  
27.0 cm, 10 5/8"  
**180-556-270**



**Wangenstein**  
27.0 cm, 10 5/8"  
**180-562-270**



10

Diese Nadelhalter mit extra schlankem Maul sind auf die Anforderungen der Gefäßchirurgie abgestimmt.

These needle holders with extremely delicate jaws meet with the particular conditions in vascular surgery.



Hegar-Vascular

EF	EF	EF	EF
1:1	1:1	1:1	1:1
14.0 cm, 5 1/2"	18.0 cm, 7"	20.0 cm, 8"	23.0 cm, 9"
<b>180-590-140</b>	<b>180-590-180</b>	<b>180-590-200</b>	<b>180-590-230</b>

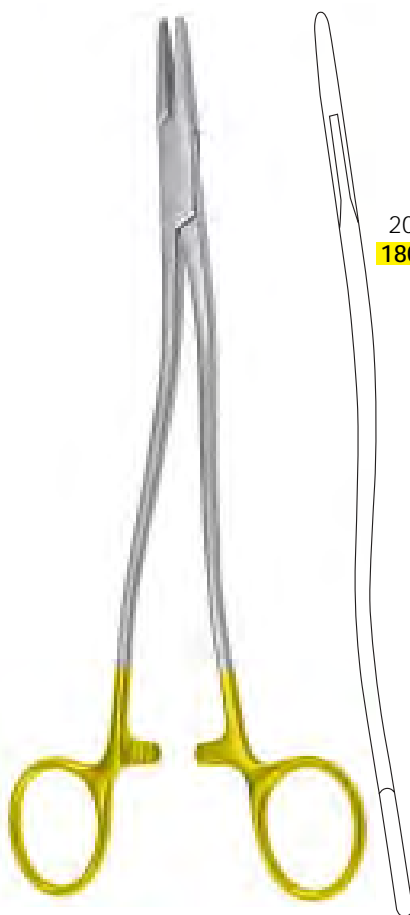

Bozemann

R	R
1:1	1:1
20.0 cm, 8"	24.0 cm, 9 5/8"
<b>180-571-200</b>	<b>180-571-240</b>

R
1:1
26.0 cm, 10 1/4"
<b>180-571-260</b>



Hegar

R	R
1:1	1:1
20.0 cm, 8"	24.0 cm, 9 1/2"
<b>180-572-200</b>	<b>180-572-240</b>



Berry Sternal

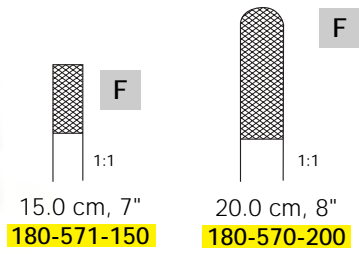

Stratte

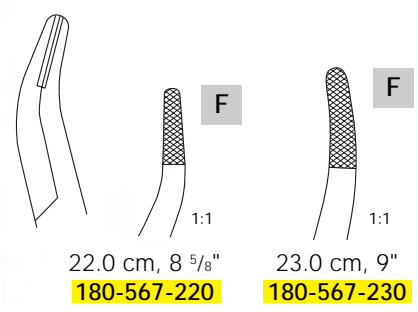

Olsen-Hegar

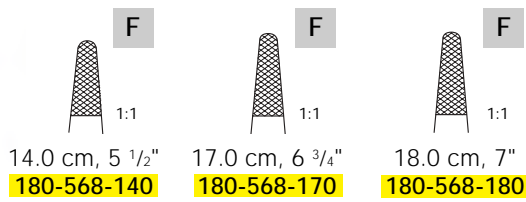

Gillies  
16.0 cm, 6 1/4"  
180-570-160

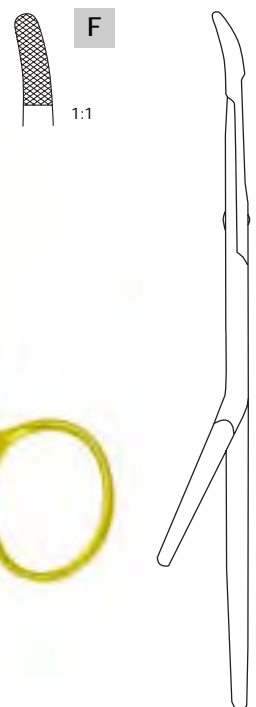



10



Mathieu-Kocher

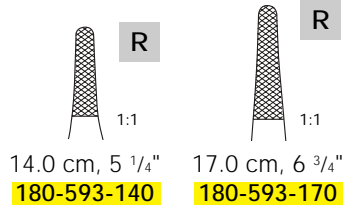

Mathieu

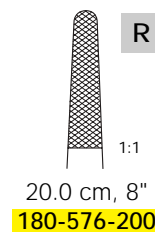
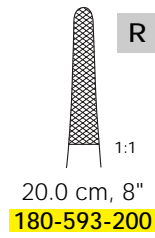
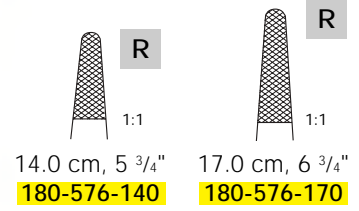

Mathieu

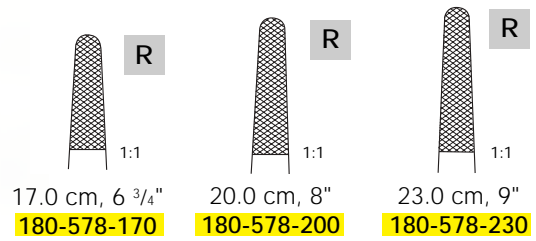



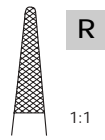

Toennis  
18.0 cm, 7"  
180-580-180

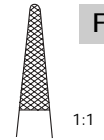

Lichtenberg  
17.0 cm, 6 3/4"  
180-582-170

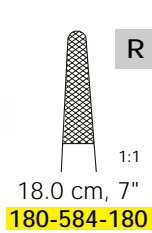

18.0 cm, 7"  
180-584-180

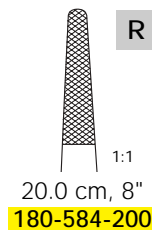

20.0 cm, 8"  
180-584-200

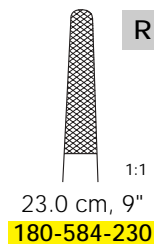

23.0 cm, 9"  
180-584-230

Langenbeck

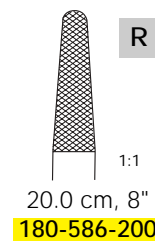

20.0 cm, 8"  
180-586-200

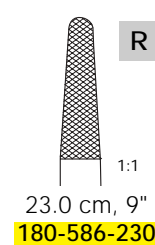

23.0 cm, 9"  
180-586-230

Zweifel



10



Reverdin  
14.0 cm, 5 1/2"

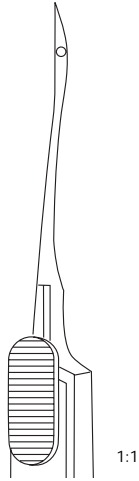

Fig. 1  
180-701-140

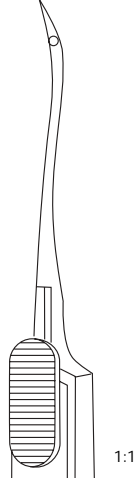

Fig. 2  
180-702-140

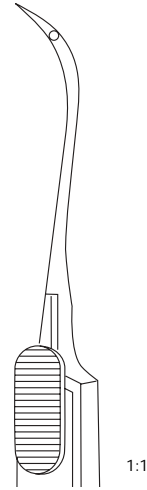

Fig. 3  
180-703-140

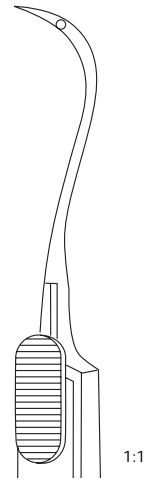

Fig. 4  
180-704-140



Reverdin

19.5 cm, 7 3/4"

22.5 cm, 8 3/4"

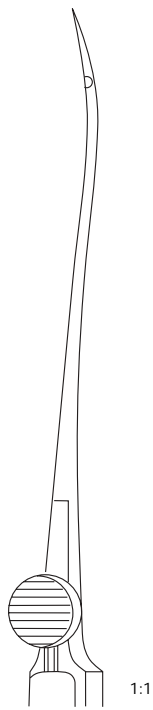

Fig. 1

180-701-195

180-701-225

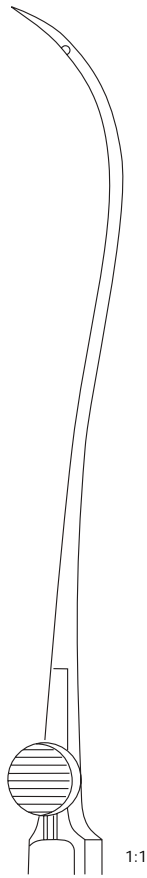

Fig. 2

180-702-195

180-702-225

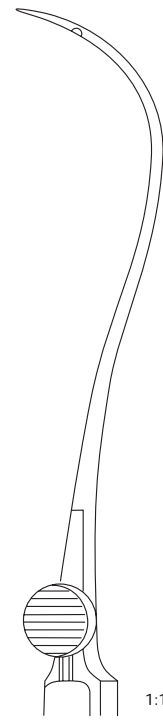

Fig. 3

180-703-195

180-703-225

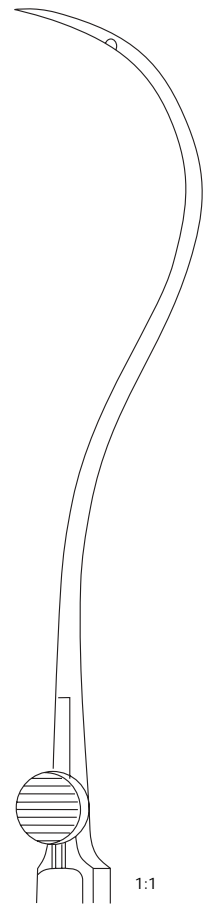
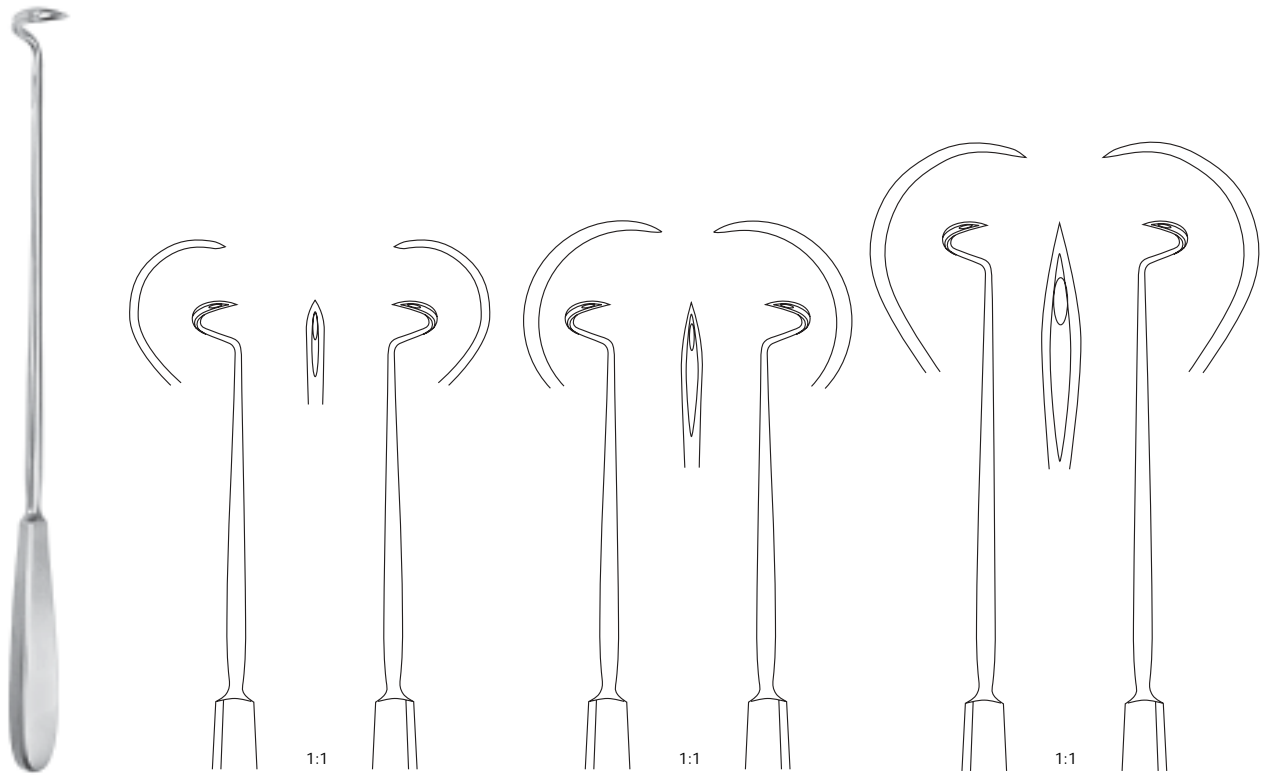

Fig. 4

180-704-195

180-704-225



Deschamps		scharf, sharp					
20.0 cm, 8"	180-736-200	180-737-200	180-724-200	180-728-200			
21.0 cm, 8 1/4"					180-728-210	180-729-210	
27.0 cm, 10 5/8"					180-732-270	180-733-270	

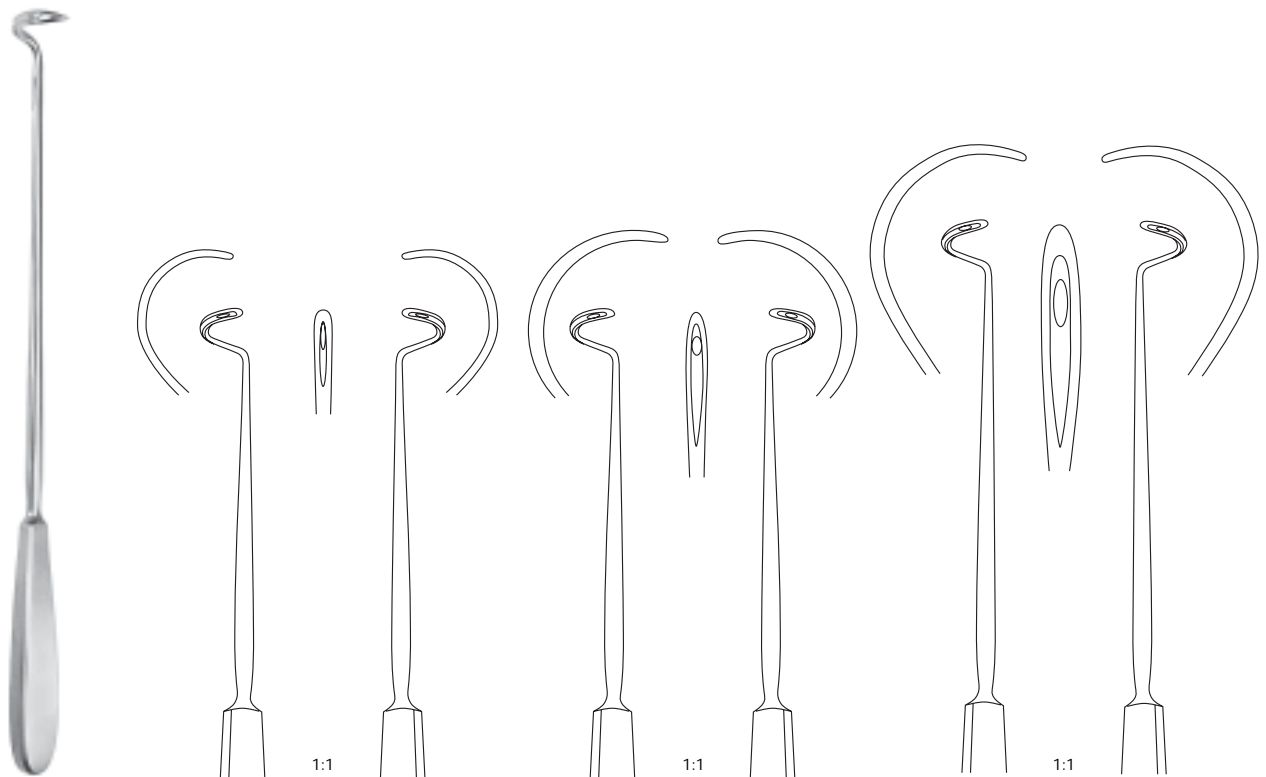

Deschamps		stumpf, blunt					
20.0 cm, 8"	180-738-200	180-739-200	180-722-200	180-723-200			
21.0 cm, 8 1/4"					180-726-210	180-727-210	
27.0 cm, 10 5/8"					180-730-270	180-731-270	



10

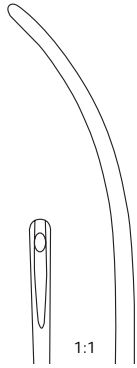
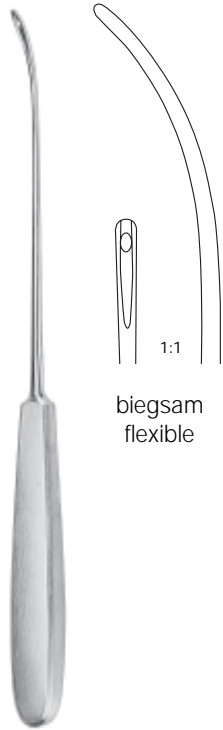

biegsam  
flexible

20.0 cm, 8"  
180-716-200

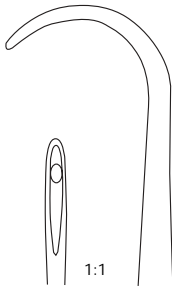
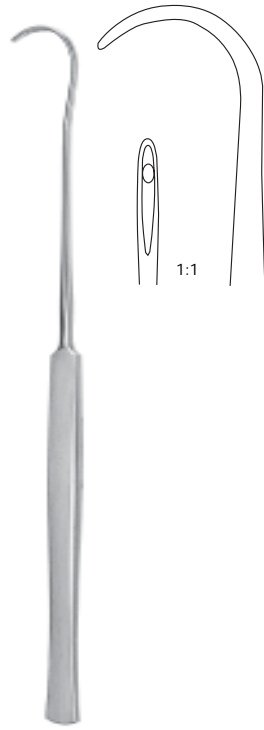

Cooper  
19.0 cm, 7 1/2"  
180-732-190

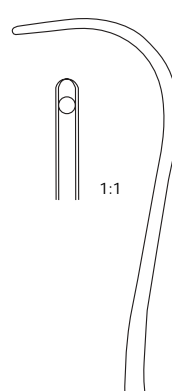

17.0cm, 6 3/4"  
180-725-170

Syme  
15.0 cm, 6"  
180-725-150

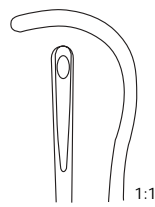

Cooper  
20.0 cm, 8"  
180-732-200

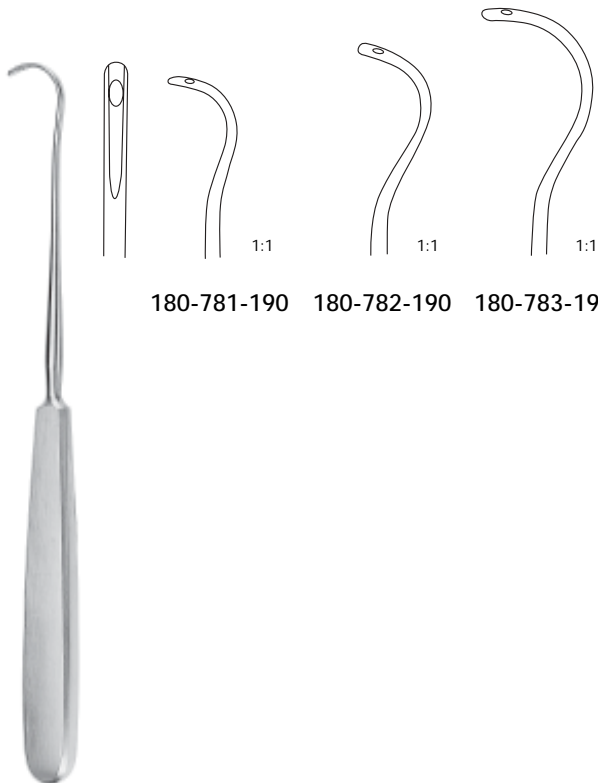

1:1



1:1



1:1

180-781-190 180-782-190 180-783-190

Kocher  
19.0 cm, 7 1/2"

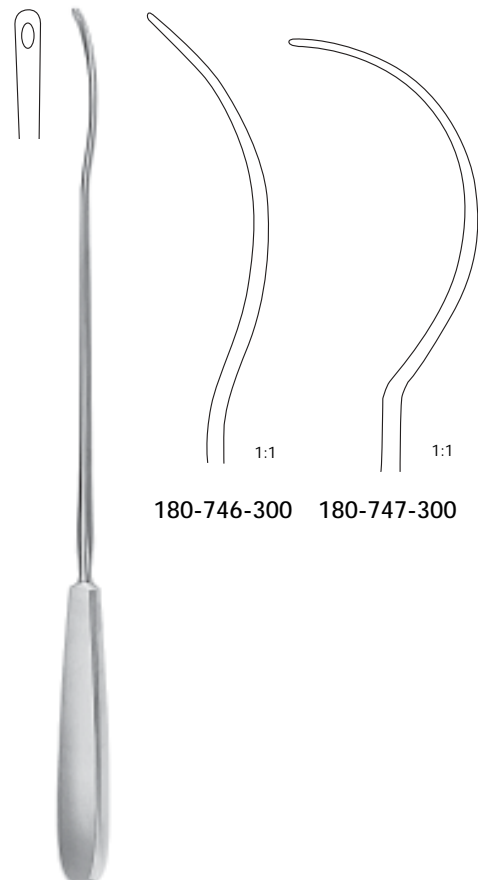

1:1

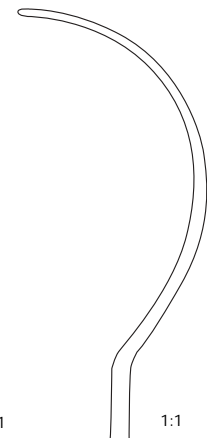

1:1

180-746-300 180-747-300

Brunner  
30.0 cm, 11 3/4"



**Young-Hryntschak**  
mit 1 Nadel 180-706-001  
with 1 needle 180-706-001  
24.0 cm, 9 1/2"  
180-706-240

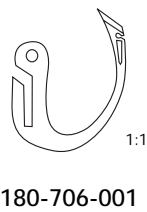

180-706-001

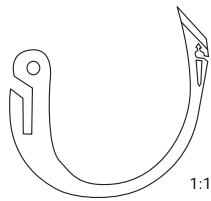

180-706-002

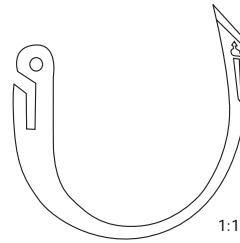

180-706-003

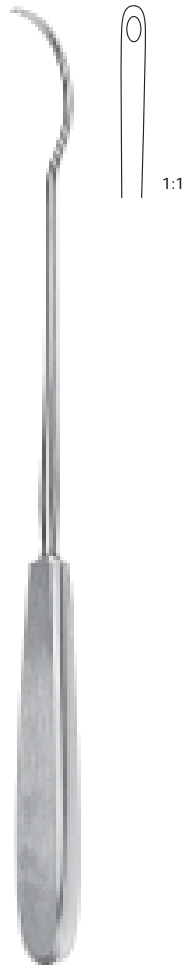

**Brunner**  
25.0 cm, 9 3/4"  
180-713-250

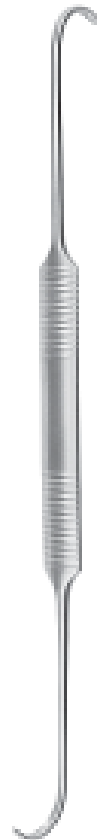

**Schmieden**  
21.0 cm, 8 1/4"  
180-712-210



**De La Roza**  
12.0 cm, 4 3/4"  
180-714-120



**De La Roza**  
12.0 cm, 4 3/4"  
180-715-120



**Jakobi**  
14.0 cm, 5 1/2"  
180-708-140

**Hesseberg**  
15.0 cm, 6"  
180-707-150

**Kronecker**  
15.0 cm, 6"  
180-752-150

**Kronecker**  
15.0 cm, 6"  
180-751-150

**Trélat**  
23.0 cm, 9"  
180-717-230

**Claus**  
23.0 cm, 9"  
180-718-230

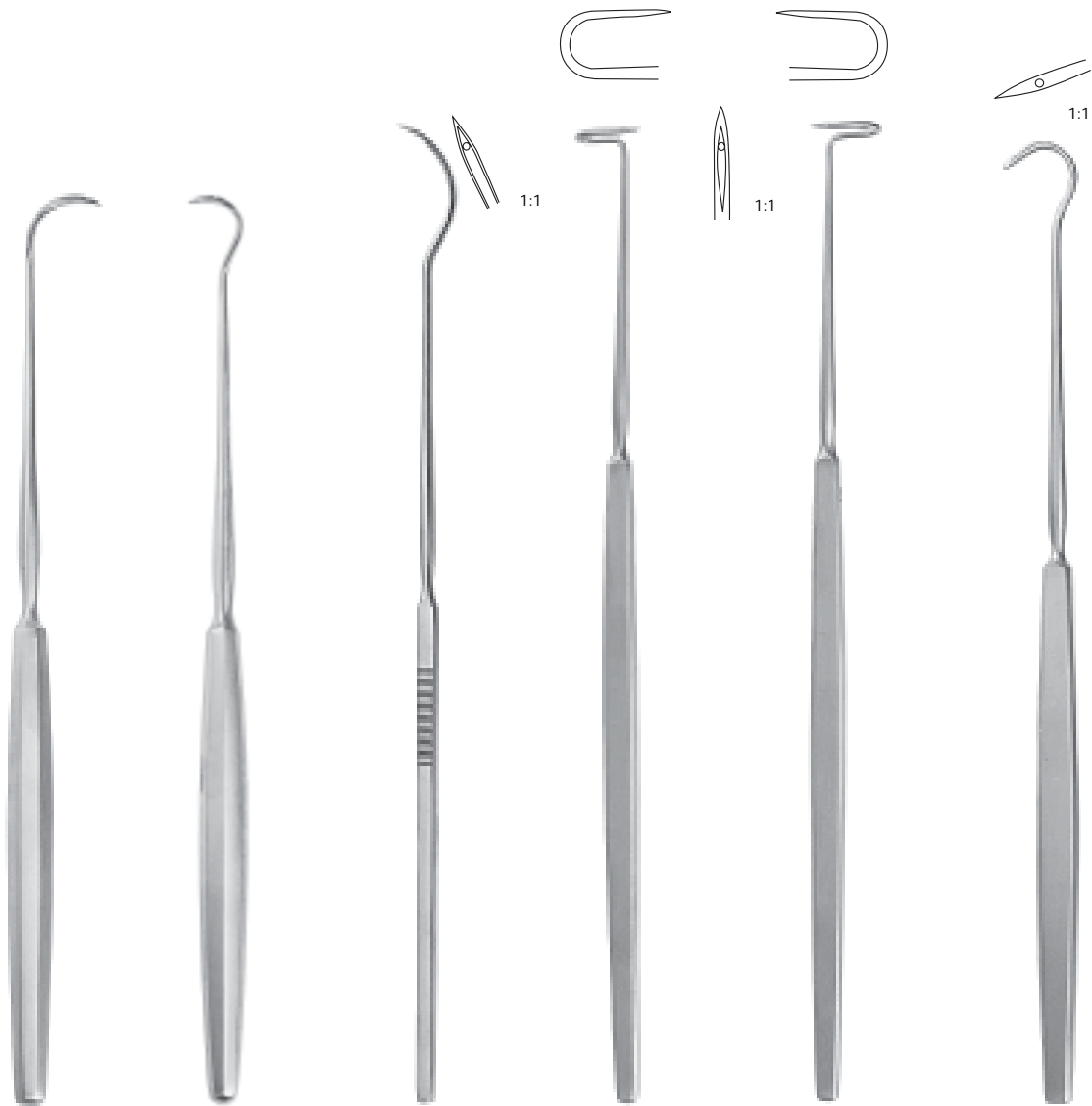

**Hurd**  
21.0 cm, 8 1/4"  
180-719-210

**Hurd**  
21.0 cm, 8 1/4"  
180-718-210

**Nager**  
24.0 cm, 9 1/2"  
180-711-240

**Falk**  
24.0 cm, 9 1/2"  
180-722-240

**Falk**  
24.0 cm, 9 1/2"  
180-723-240

**Claus-Eicken**  
23.0 cm, 9"  
180-720-230



10

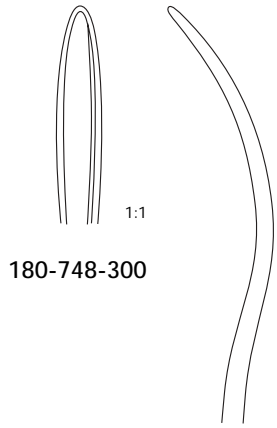
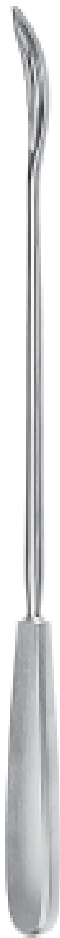

180-748-300

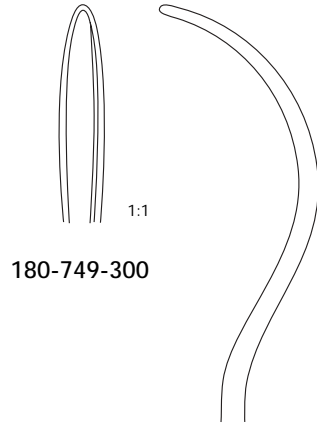

180-749-300

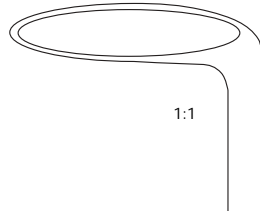

180-745-300



180-744-300

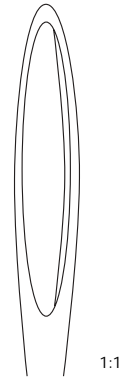

Brunner  
25.0 cm, 9 3/4"  
180-743-250





**Payr**  
22.0 cm, 8 5/8"  
180-776-220



**Payr**  
22.0 cm, 8 5/8"  
180-777-220



**Schmieden-Payr**  
19.0 cm, 7 1/2"  
180-720-190

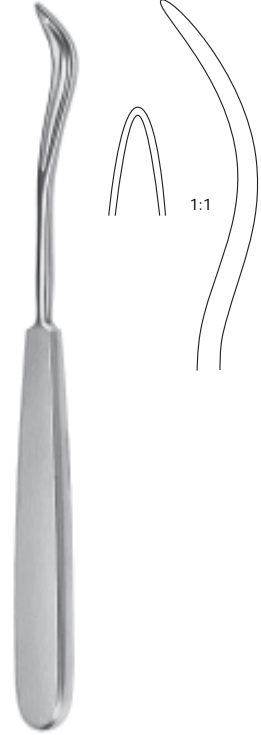

**Schmieden**  
19.0 cm, 7 1/2"  
180-770-190



**König**  
19.5 cm, 7 3/4"  
180-774-195



**König**  
19.5 cm, 7 3/4"  
180-775-195



**König**  
19.5 cm, 7 3/4"  
180-776-195



10

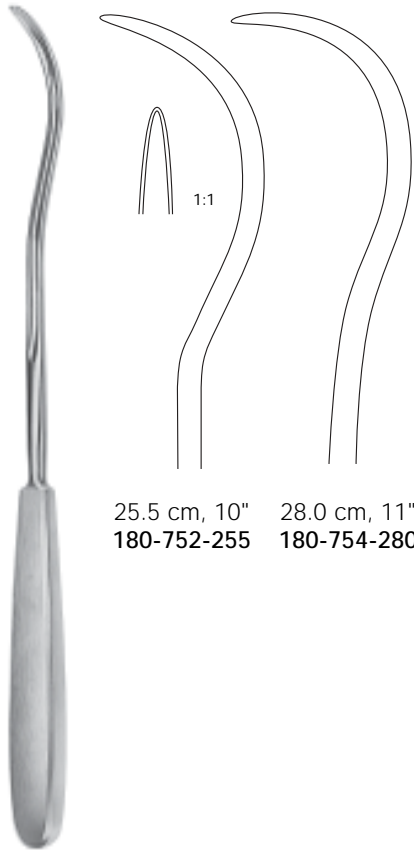

25.5 cm, 10"  
180-752-255

28.0 cm, 11"  
180-754-280

Kirschner

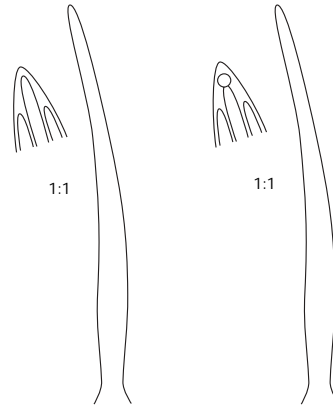

15.0 cm, 6"  
440-220-150

16.0 cm, 6 1/4"  
440-220-160

15.0 cm, 6"  
440-221-150

16.0 cm, 6 1/4"  
440-221-160

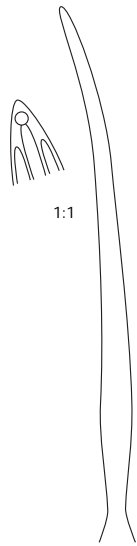

18.0 cm, 7"  
440-222-180

Kocher



**Brunner-Ferrozell**  
18.0 cm, 7"  
180-760-180

27.0 cm, 10 5/8"  
180-760-270



**Mod. Wien**  
23.5 cm, 9 1/4"  
180-778-235



**Bozemann**  
21.0 cm, 8 1/4"  
180-780-210



23.0 cm, 9"  
180-781-230



**Michel**  
Anlegen und Entfernen von  
Wundklammern  
applying and removing of clips  
12.0 cm, 4 3/4"  
180-920-120



**Collin**  
Entfernen von Wundklammern  
removing of clips  
13.0 cm, 5"  
180-934-130



**Richter-Heath**  
Entfernen von Wundklammern  
removing of clips  
14.0 cm, 5 1/2"  
180-936-140



**Wachenfeldt**  
Anlegepinzette von  
Wundklammern  
applying forceps of clips  
12.5 cm, 5"  
180-922-125



**Hegenbarth**  
Anlegepinzette von  
Wundklammern  
applying forceps of clips  
12.5 cm, 5"  
180-920-125



**Michel**  
Anlegepinzette von  
Wundklammern  
applying forceps of clips  
12.0 cm, 4 3/4"  
180-916-120



Lange  
10.0 cm, 4"  
180-906-100



Childe  
18.0 cm, 7"  
180-909-180



Childe  
18.0 cm, 7"  
180-910-180



RZ-Clip Set  
130 x 45 x 18 mm  
180-950-000

Wundnahtbesteck im Metall-Etui,  
bestehend aus:  
Wundklammerzängchen Michel zum Anlegen und Entfernen  
von Wundklammern  
Wundrand-Faßpinzette Wachenfeld mit Klammerhalter  
50 Stück Wundklammern Michel

Suture clip set in metal case,  
consisting of:  
Suture clip removing forceps Michel  
Applying forceps Wachenfeldt with clip rack  
50 pieces suture clips Michel

Verkaufseinheit: 1 Packung = 100 Stück  
Unit for Sale: 1 package = 100 ea.

7.5 x 1.75 mm **180-940-075**



11.0 x 2.0 mm **180-940-110**



12.0 x 3.0 mm **180-940-120**



14.0 x 3.0 mm **180-940-140**



16.0 x 3.0 mm **180-940-160**



18.0 x 3.0 mm **180-940-180**



20.0 x 3.0 mm **180-940-200**



22.0 x 3.0 mm **180-940-220**



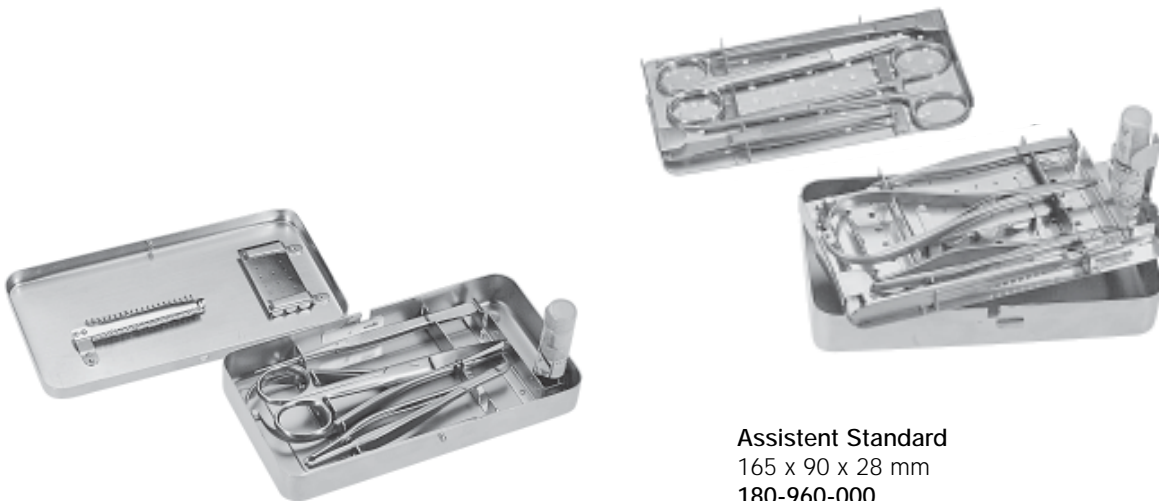

#### Mini-Assistent

165 x 90 x 20 mm

180-959-000

komplettes Besteck, in Metalletui, mit Stegen für Instrumente im Etui

Inhalt:

- 1 Nadelhalter Mathieu, 14.0 cm
- 1 Nähseide in Alkohol
- 3 Nähnadeln, sortiert
- 1 Nadeldose 50 x 25 mm, gelocht
- 1 Wundklammerzange Michel
- 20 Wundklammern auf Halter
- 1 Skalpellgriff mit Klinge
- 2 Klingen, auswechselbar
- 1 gerade Schere st./sp., 13.0 cm
- 1 feine anatomische Pinzette, 12.5 cm

complete set in metal case  
with interior instrument rack

Contents:

- 1 Mathieu Needle Holder, 5 1/2"
- 1 Flacon with sterilized silk in alcohol
- 3 Suture Needles, assorted
- 1 Needle Case, 50 x 25 mm, perforated
- 1 Michel Suture Clip Forceps
- 20 Michel Suture Clips with Clip Holder
- 1 Scalpel Handle with Blade
- 2 Scalpel Blades, interchangeable
- 1 Scissors, straight, blunt/sharp, 5"
- 1 Dressing Forceps, fine, 5"

#### Assistent Standard

165 x 90 x 28 mm

180-960-000

komplett, in Metalletui, mit 2 herausnehmbaren gelochten Einlagen mit Stegen für Instrumente



Inhalt:

- 1 Nadelhalter Mathieu, 14.0 cm
- 1 Nähseide in Alkohol
- 6 Nähnadeln, sortiert
- 1 Nadeldose 65 x 42 mm, gelocht
- 1 Wundklammerzange Michel
- 20 Wundklammern auf Halter
- 1 Skalpellgriff mit Klinge
- 3 Klingen, auswechselbar
- 1 gerade Schere Fig.2., 13.0 cm
- 1 anatomische Pinzette, 11.5 cm
- 1 Hakenpinzette, 12.0 cm, 1 x 2 Zähne
- 1 Splitterpinzette Hunter, 10.5 cm
- 1 Arterienklemme Kocher, 13.0 cm
- 1 Myrtenblattsonde, 13.0 cm





complete set in metal case with 2 removable perforated trays for instruments

Contents:

- 1 Mathieu needle holder, 5 1/2"
- 1 Flacon with sterilized silk in alcohol
- 6 Suture needles, assorted
- 1 Needle case, 64 x 42 mm, perforated
- 1 Michel suture clip forceps
- 20 Michel suture clips with clip holder
- 1 Scalpel handle with blade
- 3 Scalpel blades, interchangeable
- 1 Scissors, straight, Fig.2, 5"
- 1 Dressing forceps, fine, 4 1/2"
- 1 Tissue forceps, 4 1/2", 1 x 2 teeth
- 1 Hunter splinter forceps, 4 1/8"
- 1 Kocher artery forceps, straight, 5"
- 1 Probe with myrtle leaf, 5"

 <p><b>Schede</b> 17.0 cm, 6 3/4" 210-...</p>	 <p><b>Volkmann</b> 17.0 cm, 6 3/4" 210-...</p>	 <p><b>Bruns</b> 16.0 cm, 6 1/4" 210-...</p>
<p>Fig. 000 300-300</p> <p>Fig. 0 300-100</p> <p>Fig. 1 300-010</p> <p>Fig. 2 300-020</p> <p>Fig. 3 300-030</p> <p>Fig. 4 300-040</p>	<p>Fig. 0000 304-400</p> <p>Fig. 0 304-100</p> <p>Fig. 1 304-010</p> <p>Fig. 2 304-020</p> <p>Fig. 3 304-030</p> <p>Fig. 4 304-040</p> <p>Fig. 5 304-050</p> <p>Fig. 6 304-060</p>	<p>Fig. 0000 306-400</p> <p>Fig. 0 306-100</p> <p>Fig. 1 306-010</p> <p>Fig. 2 306-020</p> <p>Fig. 3 306-030</p> <p>Fig. 4 306-040</p> <p>Fig. 5 306-050</p> <p>Fig. 6 306-060</p>

biegsam  
malleable

 <p><b>Lempert</b> 21.5 cm, 8 1/2"</p>	 <p><b>Halle</b> 21.0 cm, 8 1/4"</p>	 <p><b>Daubenspeck</b> 20.0 cm, 8"</p>	 <p><b>Williger</b> 17.0 cm, 6 3/4"</p>
<p>Fig. 0000 210-348-400</p> <p>Fig. 000 210-348-300</p> <p>Fig. 00 210-348-200</p> <p>Fig. 0 210-348-100</p> <p>Fig. 1 210-348-010</p>	<p>Fig. 00 210-350-200</p> <p>Fig. 0 210-350-100</p> <p>Fig. 1 210-350-010</p>	<p>Fig. 00 210-217-200</p> <p>Fig. 0 210-217-100</p> <p>Fig. 1 210-217-010</p> <p>Fig. 2 210-217-020</p>	<p>Fig. 1 210-294-010</p> <p>Fig. 2 210-294-020</p>



**Volkman**



13.0 cm, 5"  
210-210-130



14.0 cm, 5 1/2"  
210-210-140



17.0 cm, 6 3/4"  
210-210-170



**Williger**  
14.0 cm, 5 1/2"  
210-215-140



**Jansen**  
15.0 cm, 6"  
210-216-150



**Martini**  
14.0 cm, 5 1/2"  
210-218-140



**Martini**  
14.0 cm, 5 1/2"  
210-219-140



**Jansen**  
16.0 cm, 6 1/4"  
210-218-160



**Watson-Cheyne**  
17.5 cm, 6 5/8"  
210-525-175



**McDonald**  
19.0 cm, 7 1/2"  
210-527-190

11

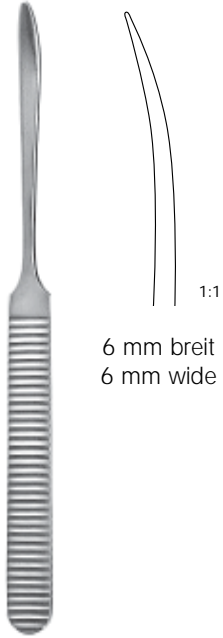

6 mm breit  
6 mm wide

**Williger**

17.0 cm, 6 3/4"  
210-396-170

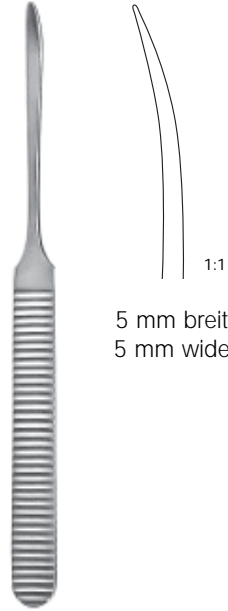

5 mm breit  
5 mm wide

**Williger**

16.0 cm, 6 1/4"  
210-395-160

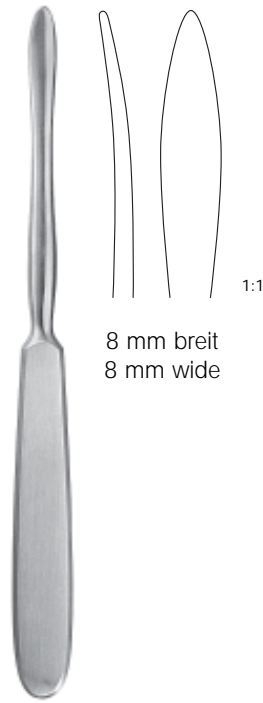

8 mm breit  
8 mm wide

**Langenbeck**

20.0 cm, 8"  
210-395-200

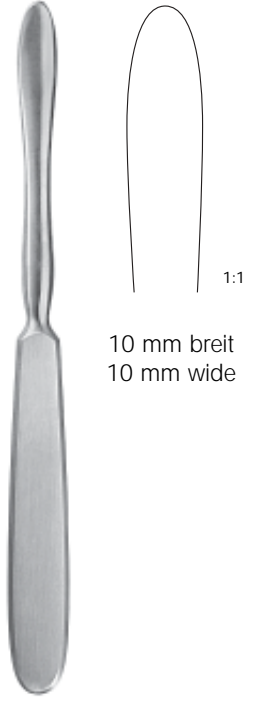

10 mm breit  
10 mm wide

**Langenbeck**

20.0 cm, 8"  
210-397-200

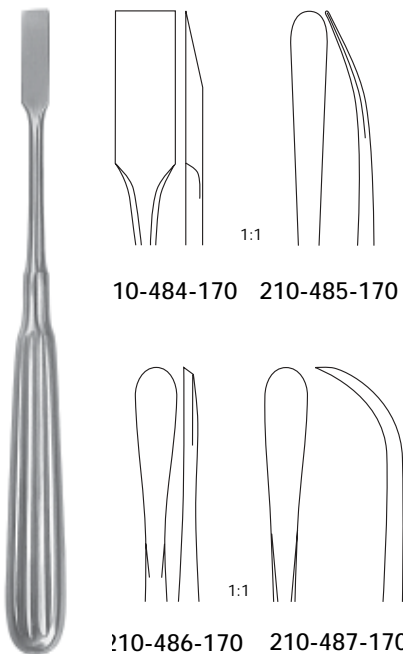

10-484-170 210-485-170

10-486-170 210-487-170

**Adson**

17.0 cm, 6 3/4"



**König**

15.5 cm, 6"  
210-553-150

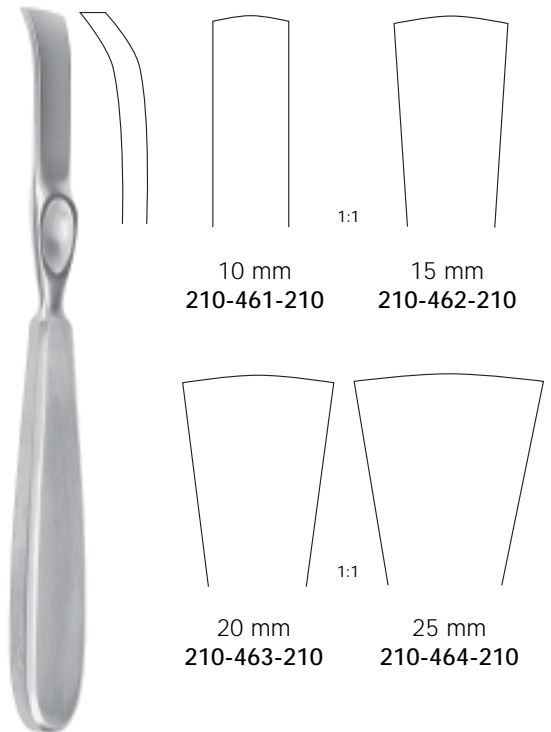

10 mm  
210-461-210

15 mm  
210-462-210

20 mm  
210-463-210

25 mm  
210-464-210

**Lambotte**

21.0 cm, 8 1/4"



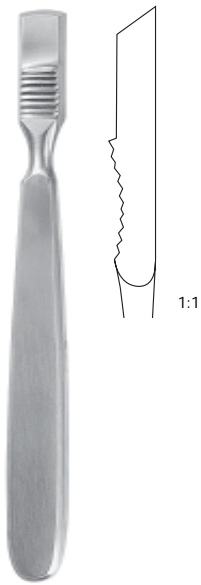

**Farabeuf**  
15.0 cm, 6"  
210-310-150

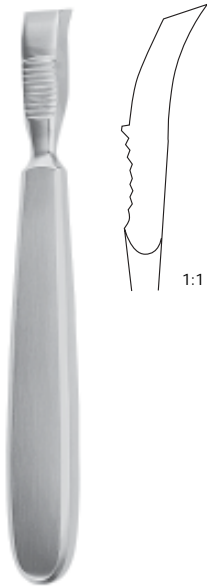

**Farabeuf**  
15.0 cm, 6"  
210-311-150

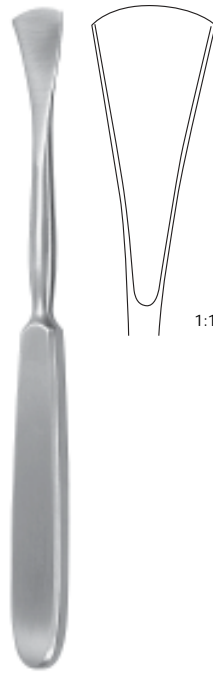

**Langenbeck**  
19.0 cm, 7 1/2"  
210-303-190



**Sedillot**  
21.0 cm, 8 1/4"  
210-315-210



**Williger**  
16.0 cm, 6 1/4"  
210-436-160



**Doyen**  
17.0 cm, 6 3/4"



**Doyen**  
17.0 cm, 6 3/4"

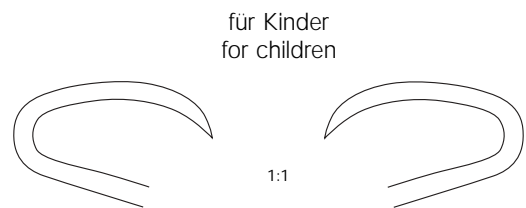

210-335-170

210-337-170

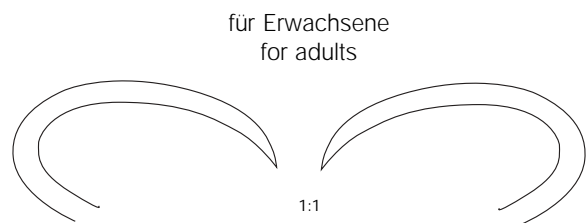

210-331-170

210-333-170



11



Breite width mm	13.5 cm, 5 3/8"	13.5 cm, 5 3/8"	13.5 cm, 5 3/8"
8	210-008-135	210-108-135	210-208-135
10	210-010-135	210-110-135	210-210-135
12	210-012-135	210-112-135	210-212-135
14	210-014-135	210-114-135	210-214-135
16	210-016-135	210-116-135	210-216-135

Breite width mm	Partsch 13.5 cm, 5 3/8"	Partsch 13.5 cm, 5 3/8"
3	210-303-135	210-403-135
4	210-304-135	210-404-135
5	210-305-135	210-405-135
6	210-306-135	210-406-135



Breite width mm	Alexander	Alexander
	18.0 cm, 7"	18.0 cm, 7"
4	210-504-180	210-604-180
6	210-506-180	210-606-180
8	210-508-180	210-608-180
10	210-510-180	210-610-180
12	210-512-180	210-612-180
14	210-514-180	210-614-180

Breite width mm	Stille	Stille	Stille
	20.0 cm, 8"	20.0 cm, 8"	20.0 cm, 8"
10	210-710-200	210-810-200	210-510-200
15	210-715-200	210-815-200	210-515-200
20	210-720-200	210-820-200	210-520-200
25	210-725-200	210-825-200	210-525-200



Breite width mm	Smith-Petersen 20.0 cm, 8"	Smith-Petersen 20.0 cm, 8"	Smith-Petersen 20.0 cm, 8"	Smith-Petersen 20.0 cm, 8"	Lambotte 24.0 cm, 9 1/2"	Lambotte 24.0 cm, 9 1/2"
6	210-106-200	210-206-200			210-132-006	210-133-006
9	210-109-200	210-209-200	210-309-200	210-409-200		
13	210-113-200	210-213-200	210-313-200	210-413-200		
15					210-132-015	210-133-015
16	210-116-200	210-216-200	210-316-200	210-416-200		
19	210-119-200	210-219-200	210-319-200	210-419-200		
20					210-132-020	210-133-020
25	210-125-200	210-225-200	210-325-200	210-425-200	210-132-025	210-133-025
32	210-132-200	210-232-200			210-132-032	210-133-032
38					210-132-038	210-133-038
44					210-132-044	210-133-044
50					210-132-050	210-133-050



ø 30 mm  
220 g

Collin  
20.0 cm, 8"  
210-220-200



ø 22 mm  
200 g  
Bleifüllung  
lead filled

Partsch  
18.0 cm, 7"  
210-224-180



300 g  
Bleifüllung  
lead filled

Bergmann  
24.0 cm, 9 1/2"  
210-300-240



12

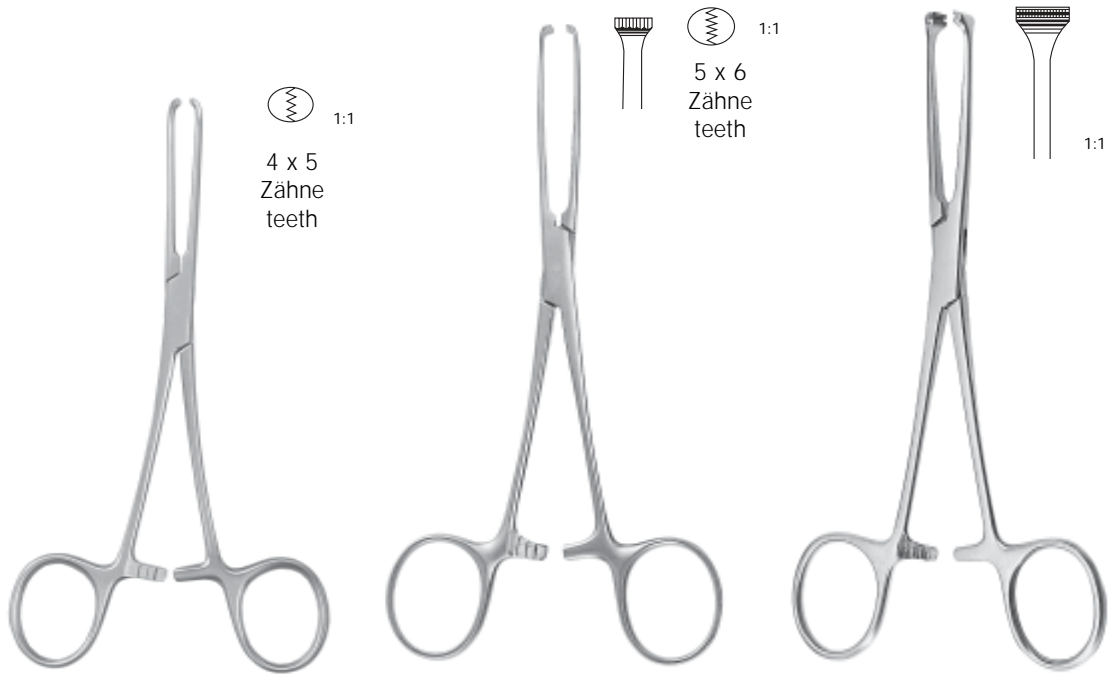

	Allis-Baby	Allis	Allis-Atrauma
12.0 cm, 4 3/4"	310-010-120		
15.0 cm, 6"	310-010-150	310-014-150	
16.0 cm, 6 1/4"			310-020-160
19.0 cm, 7 1/2"		310-014-190	
20.0 cm, 8"			310-020-200
25.0 cm, 9 3/4"		310-014-250	310-020-250

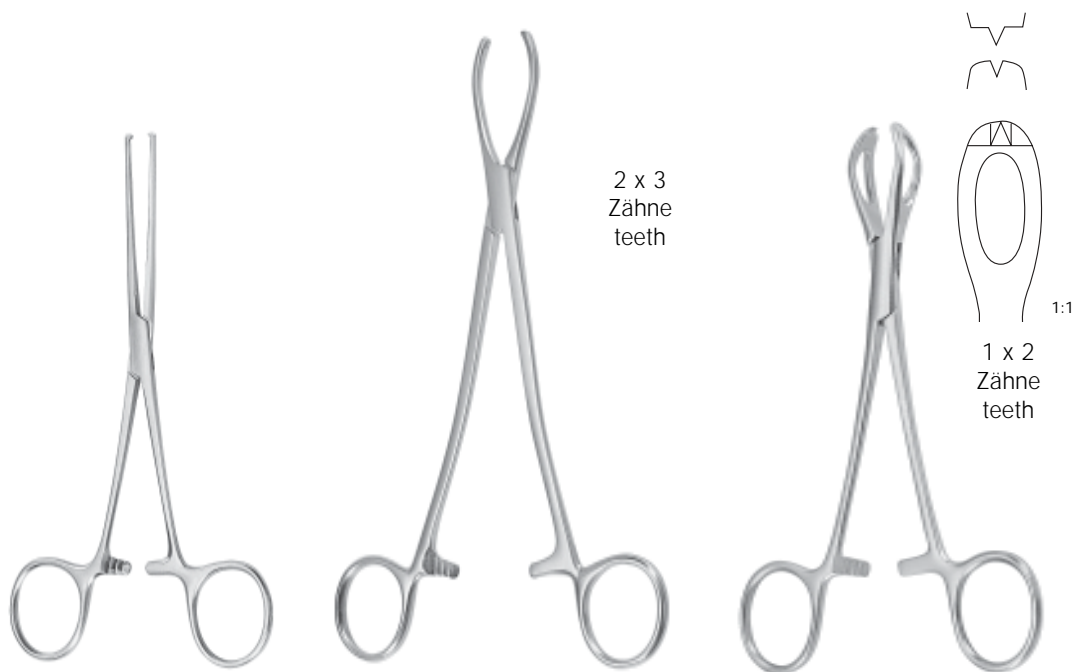

	Allen	Littlewood	Lane
12.5 cm, 5"			310-030-125
15.0 cm, 6"			310-030-150
15.5 cm, 6"	310-116-155		
18.5 cm, 7 1/4"		310-025-185	
19.5 cm, 7 3/4"			310-030-195
20.0 cm, 8"	310-116-200		
23.0 cm, 9"	310-116-230		

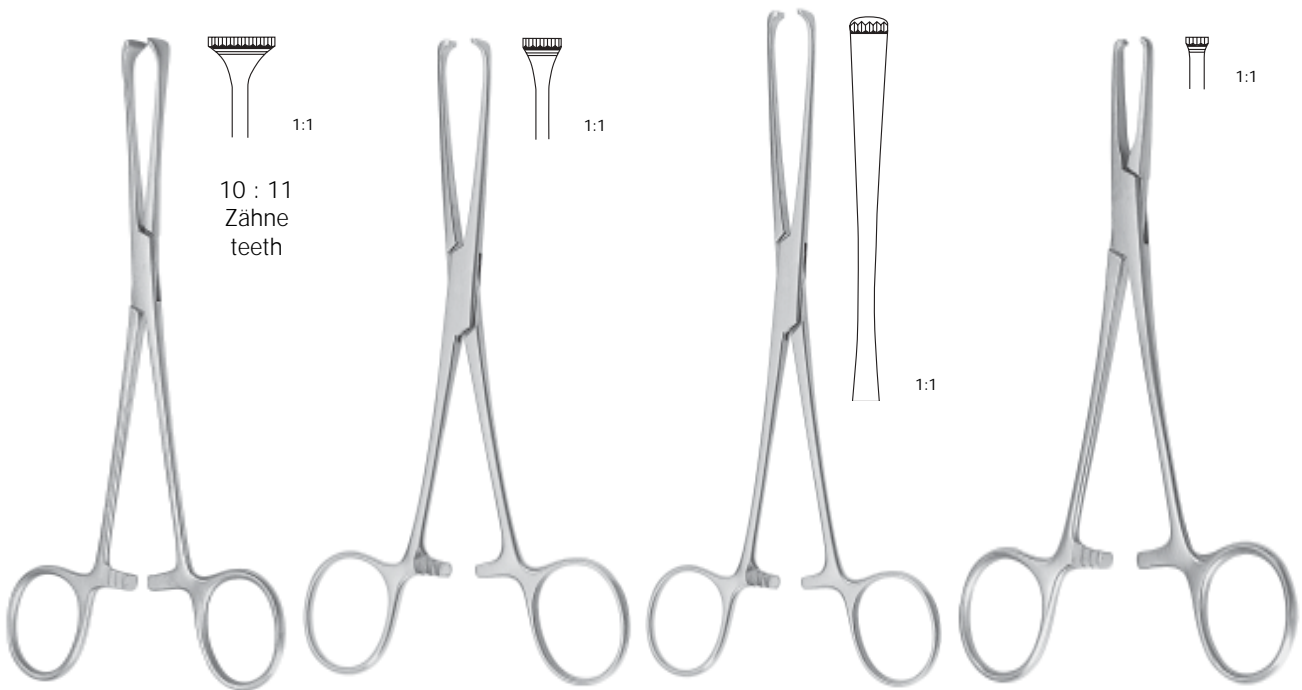

**Allis-Adair**  
15.5 cm, 6"  
310-027-155

**Boys-Allis**  
15.5 cm, 6"  
310-029-155

**Lockwood-Allis**  
16.0 cm, 6 1/4"  
310-026-160  
20.0 cm, 8"  
310-026-200

**Judd-Allis**  
15.0 cm, 6"  
310-028-150  
19.0 cm, 7 1/2"  
310-026-190

12

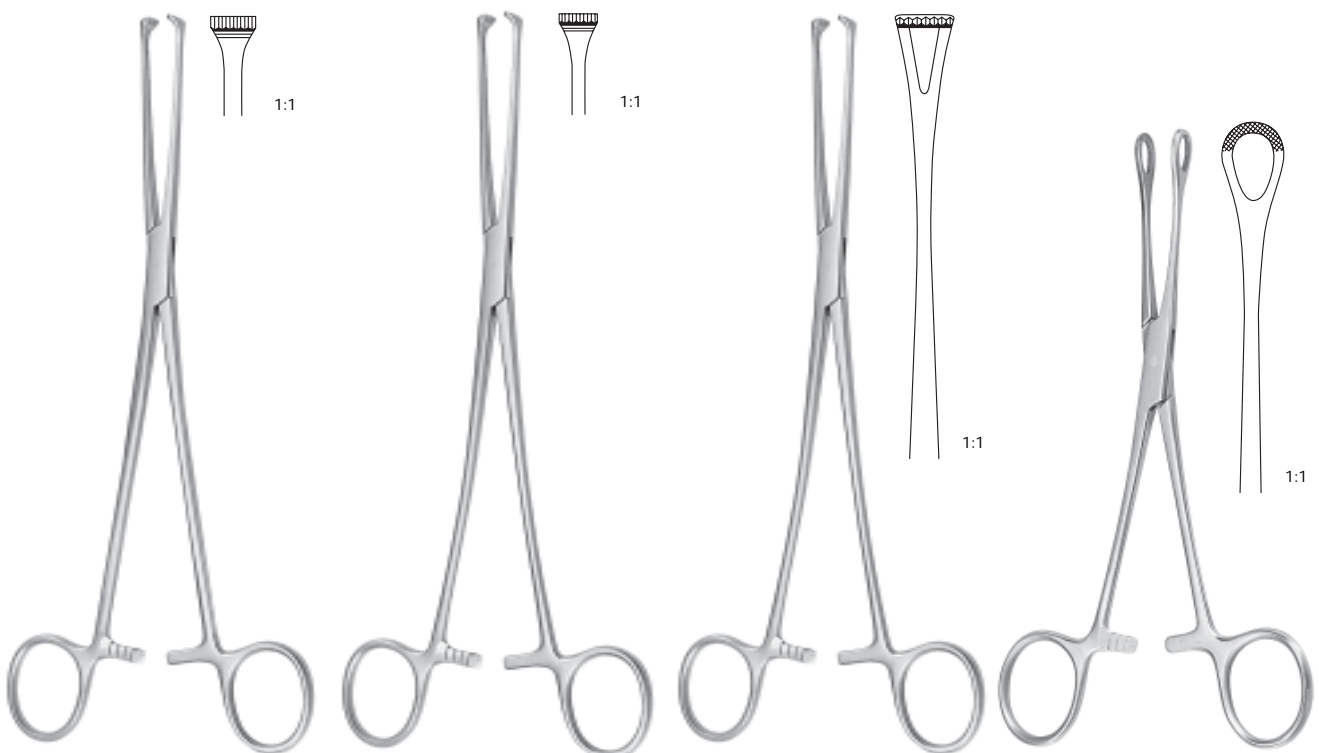

**Thoms-Allis**  
20.0 cm, 8"  
310-030-200

**Allis**  
20.0 cm, 8"  
310-031-200

**Lockwood**  
20.0 cm, 8"  
310-100-200

**Williams**  
16.0 cm, 6 1/4"  
310-115-160



12

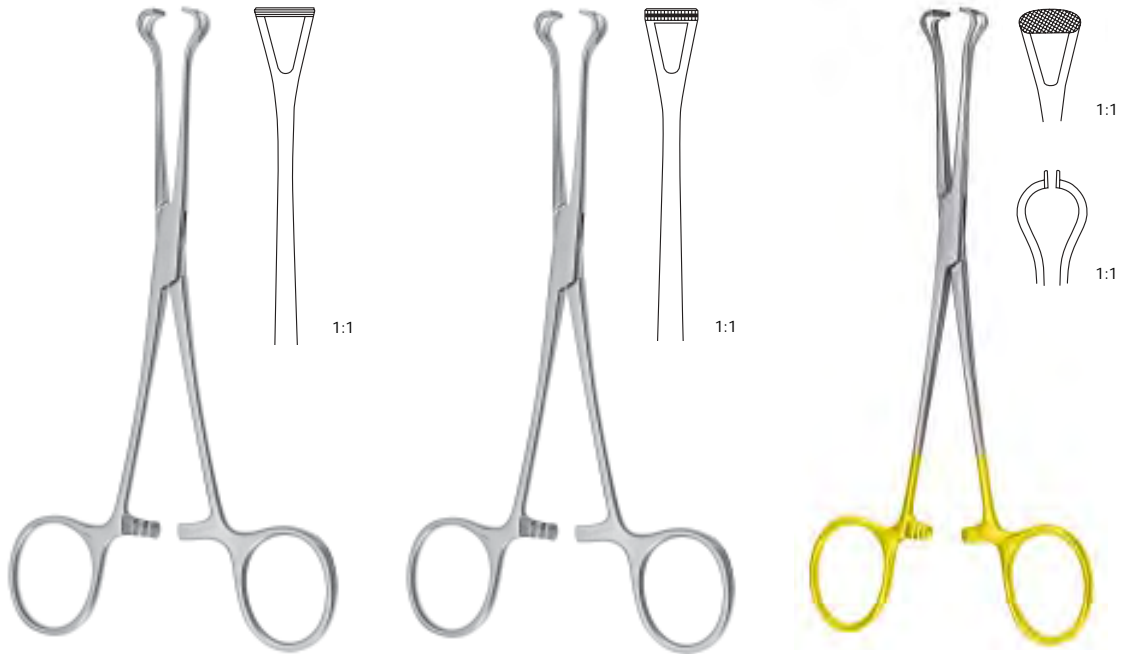

	Babcock	Babcock-Atrauma	Babcock
16.0 cm, 6 1/4"	310-110-160	310-111-160	310-118-160
18.0 cm, 7"	310-110-180		
20.0 cm, 8"	310-110-200	310-111-200	310-118-200
24.0 cm, 9 1/2"	310-110-240		



Duval

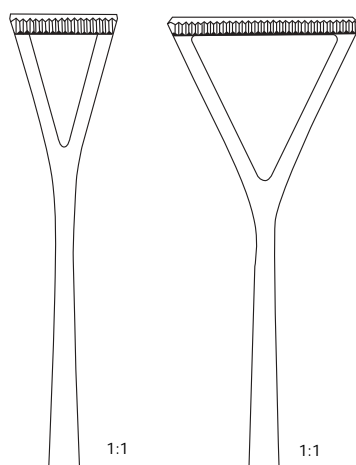

18.0 cm, 7"  
310-112-180  
20.0 cm, 8"  
310-112-200

20.0 cm, 8"  
310-114-200  
23.0 cm, 9"  
310-114-230



Duval  
20.0 cm, 8"  
310-113-200

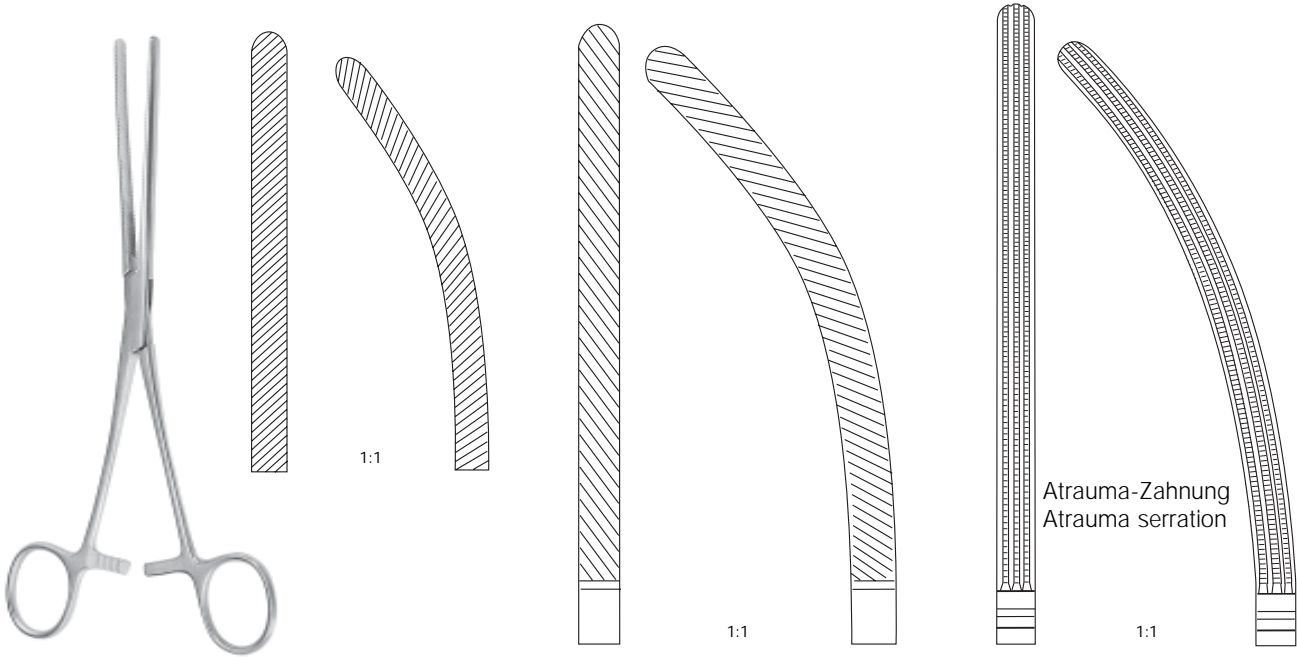

Doyen-Baby		Doyen		Doyen	
16.0 cm, 6 1/4"				310-550-160	310-551-160
18.0 cm, 7"	310-290-180	310-291-180		310-550-180	310-551-180
21.0 cm, 8 1/4"			310-290-210	310-291-210	310-550-210
23.0 cm, 9"			310-290-230	310-291-230	310-550-230

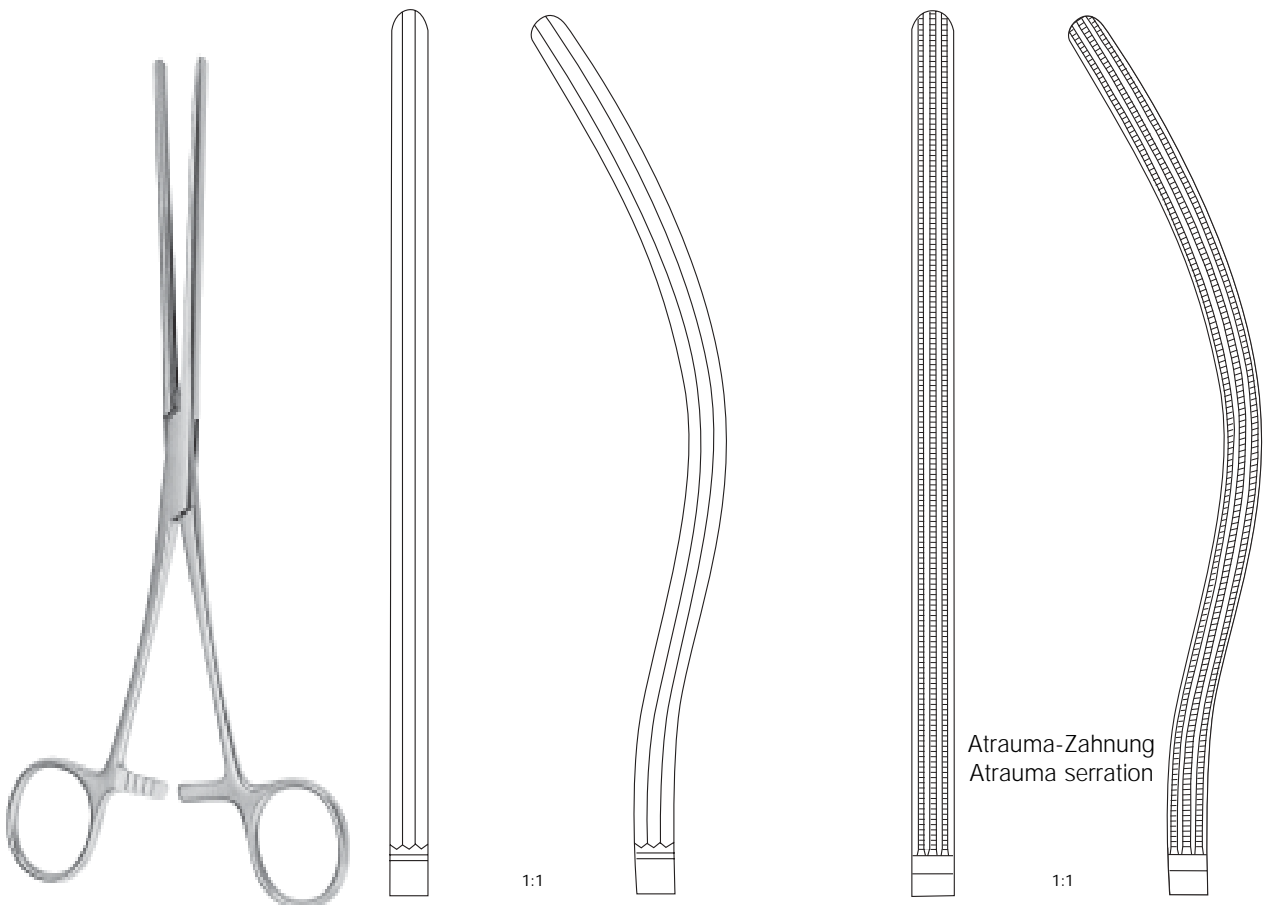

Kocher					
22.0 cm, 8 5/8"	310-124-220	310-125-220	310-126-220	310-127-220	
25.0 cm, 9 3/4"	310-124-250	310-125-250	310-126-250	310-127-250	
28.0 cm, 11"	310-124-280	310-125-280	310-126-280	310-127-280	



12

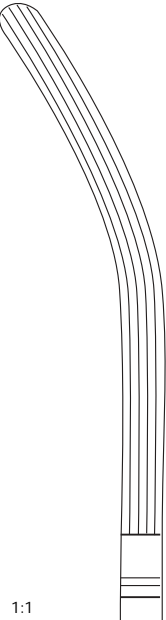
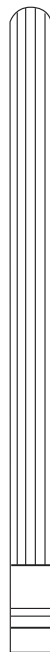

1:1

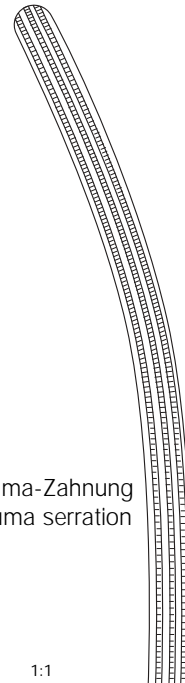
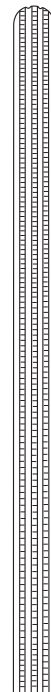

1:1

Atrauma-Zahnung  
Atrauma serration

Mayo Robson

21.0 cm, 8 1/4"	310-130-210	310-131-210	310-140-210	310-141-210
23.0 cm, 9"	310-130-230	310-131-230	310-140-230	310-141-230
25.0 cm, 9 3/4"	310-130-250	310-131-250	310-140-250	310-141-250

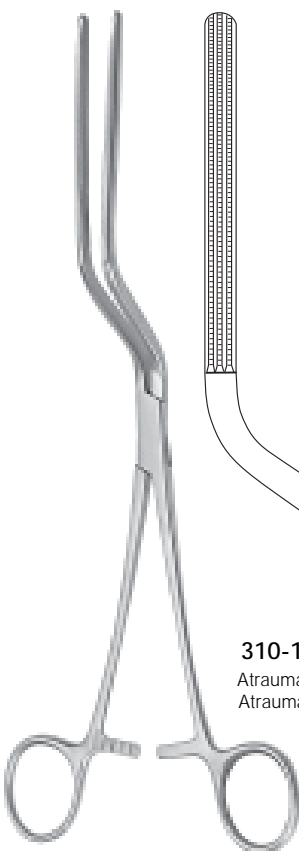

Brunner  
24.0 cm, 9 1/2"  
310-150-240

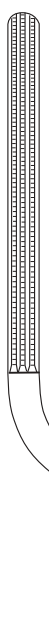

310-150-240  
Atrauma-Zahnung  
Atrauma serration

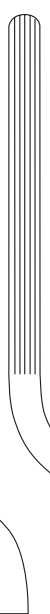

310-151-240

1:1

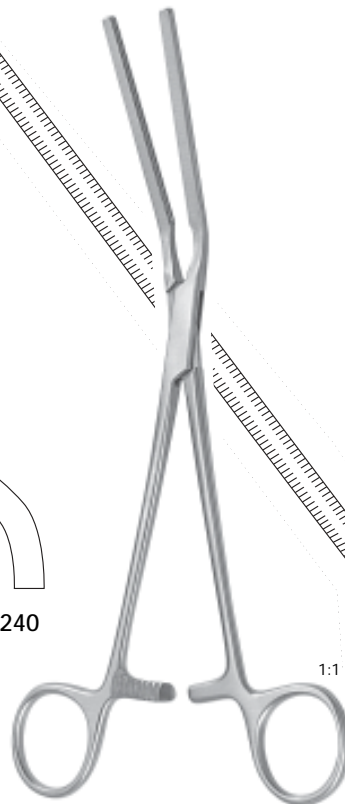
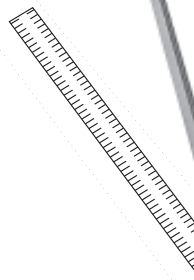

Glassman  
22.9 cm, 9"  
310-200-229

1:1

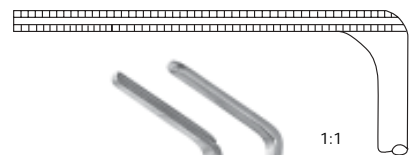

1:1



Glassman  
23.5 cm, 9 1/4"  
310-201-235



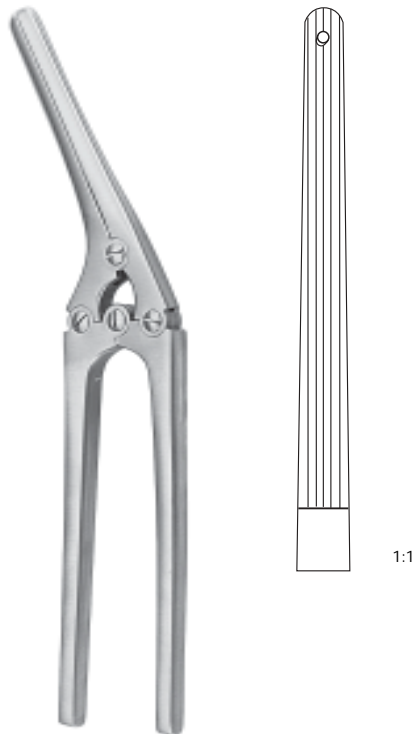

	ohne Stift without pin	mit Stift with pin
<b>Payr</b>		
21.0 cm, 8 1/4"	310-032-210	310-033-210
29.0 cm, 11 1/2"	310-032-290	310-033-290

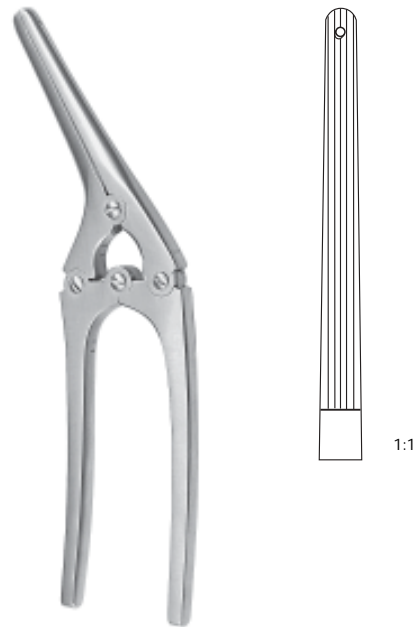

	ohne Stift without pin	mit Stift with pin
<b>Payr-Baby</b>		
15.0 cm, 6"	310-031-150	310-032-150

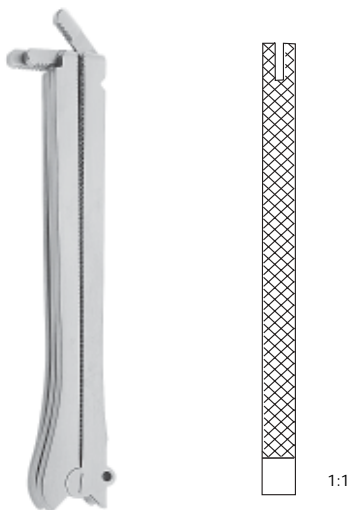

**De Martel-Wolfson**  
Satz zu 3 Klemmen, Set of 3 clamps  
Maullänge  
jaw length

5.0 cm, 2"	310-400-005
7.0 cm, 2 1/4"	310-400-007
10.0 cm, 4"	310-400-010



8.5 cm, 3 1/2"  
310-410-085



**De-Martel-Wolfson**  
26.0 cm, 10 1/4"  
310-412-260



12

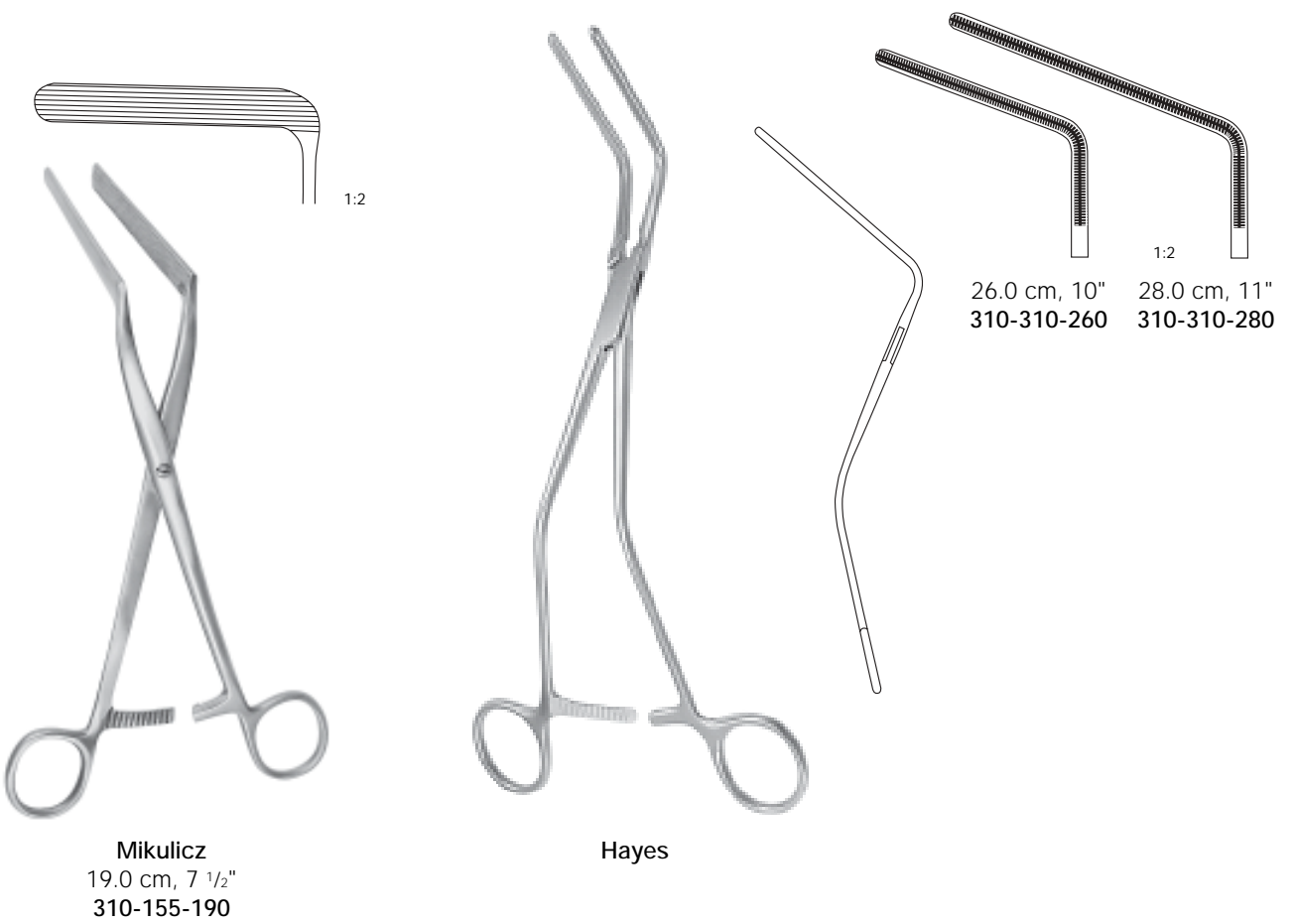
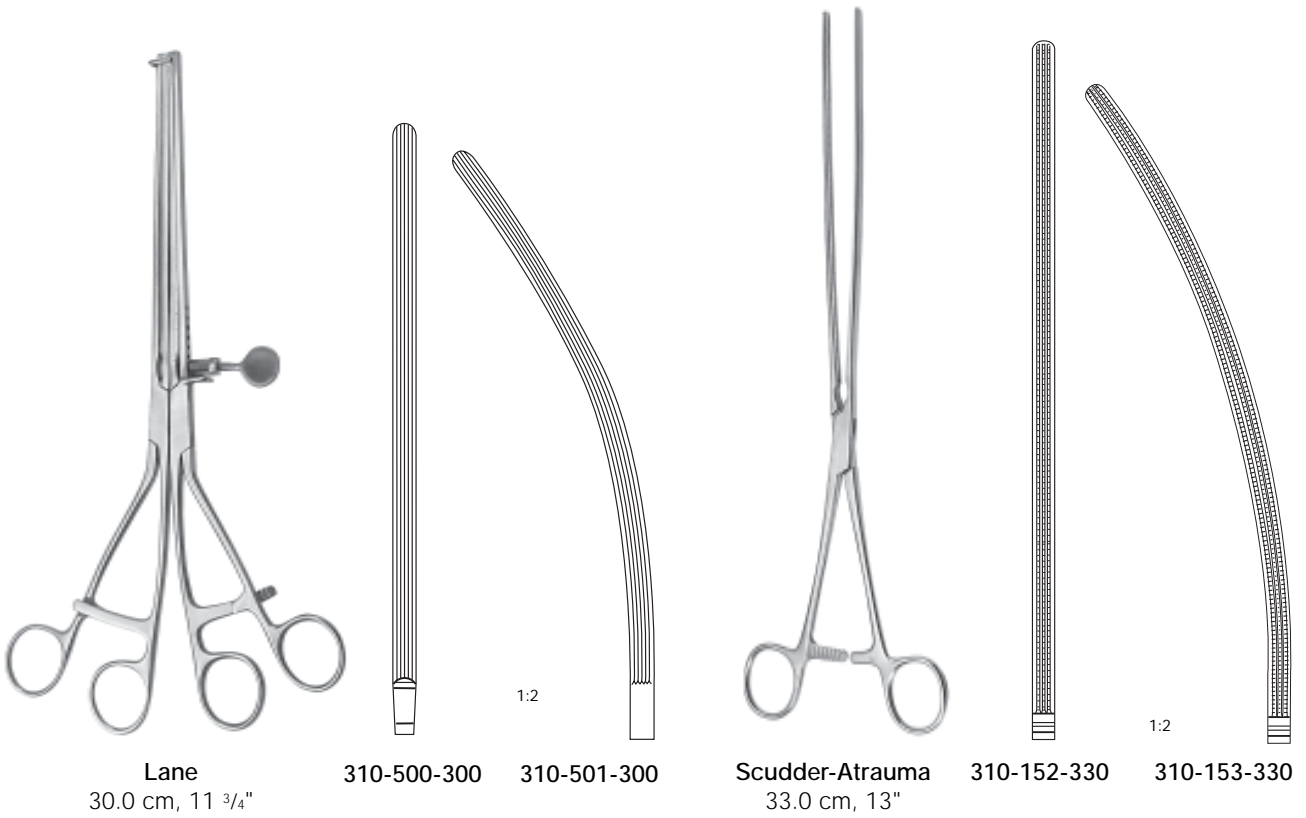



17 x 89 mm

**Sims**  
 15.0 cm, 6"  
 310-603-150



17 x 89 mm

**Bodenhammer**  
 15.0 cm, 6"  
 310-601-150



25 x 89 mm

**Mathieu**  
 21.0 cm, 8 1/4"  
 310-606-210

Mittelvalve allein  
 Central blade only  
 25 x 95 mm  
 310-025-095



Valve, blade  
 22 x 95 mm  
 310-022-095

Valve, blade  
 22 x 75 mm  
 310-022-075



75 x 23 mm

**Smith-Buie**  
 15.0 cm, 6"  
 310-610-150



Sperrer, allein  
 Spreader, only  
 310-022-135

**Alan Parks komplett**  
 13.5 cm, 5 3/8"  
 310-020-135

Die Alan Park Anal- und Sphinkterotomie Retraktor Kombination hat den Vorteil, daß alle Valven austauschbar sind und somit sowohl für Erwachsene als auch für Kinder geeignet ist. Alle Valven sind speziell geformt, um den anatomischen Bedingungen des Körpers gerecht zu werden. Sie sind aus dünnwandigem Material hergestellt, um das Einführen zu erleichtern.

The Alan Park anal and sphincterotomy retractor combination provides interchangeable blades for use in children and adults. All blades are specially rounded and shaped to meet anatomical requirements. They are slightly tapered and lipped to facilitate insertion.



**Kelly**

22 mm ø x 50 mm	310-675-050
22 mm ø x 100 mm	310-675-100
22 mm ø x 145 mm	310-675-145
22 mm ø x 200 mm	310-675-200
21 mm ø x 50 mm	310-679-210
27 mm ø x 50 mm	310-679-270



**Hirschmann**

Fig 1: 16 mm ø x 65 mm	310-655-001
Fig 2: 19 mm ø x 65 mm	310-655-002
Fig 3: 22 mm ø x 65 mm	310-655-003
Fig 4: 22 mm ø x 130 mm	310-655-004



**Chelsea Eaton**  
22 mm ø x 65 mm  
310-022-065  
30 mm ø x 65 mm  
310-030-065



**Ives Fansler**  
22 mm ø  
mit Kaltlichtanschluß  
with cold light connection  
310-695-022  
ohne Kaltlichtanschluß  
without cold light connection  
310-695-122



Beleuchtungsstab für Morgan  
 Proktoskope  
 Illumination adapter for Morgan  
 proctoscope  
 310-710-000



Morgan	
17 mm ø x 65 mm	310-700-065
17 mm ø x 80 mm	310-700-080
20 mm ø x 65 mm	310-701-065
20 mm ø x 80 mm	310-701-080
24 mm ø x 65 mm	310-702-065
24 mm ø x 80 mm	310-702-080



Kaltlichtklammer  
 für Proktoskope  
 Cold light mounting clip  
 for proctoscopes  
 310-710-100

Fansler	
25 mm ø x 65 mm	310-705-025
29 mm ø x 65 mm	310-705-029
38 mm ø x 70 mm	310-705-038

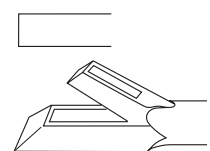
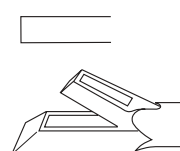
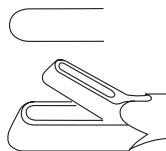
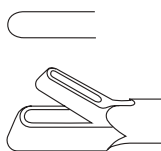

Yeoman	Fig. 1	Fig. 2	Fig. 3	Fig. 4
28.0 cm, 11"	310-720-280	310-721-280	310-722-280	310-723-280
35.0 cm, 13 3/4"	310-720-350	310-721-350	310-722-350	310-723-350
42.0 cm, 16 1/2"	310-720-420	310-721-420	310-722-420	310-723-420



Ladekegel, cone 12 mm  
340-012-000



**Rudd Hämorrhoiden-Ligator**  
mit Ladekegel 12 mm und 100 Gummiringen  
with 12 mm cone and 100 rubber rings  
340-010-000

Ligatur Gummiringe, Pack à 100 Stück  
Ligature rubber ring, package of 100 pieces  
340-011-000

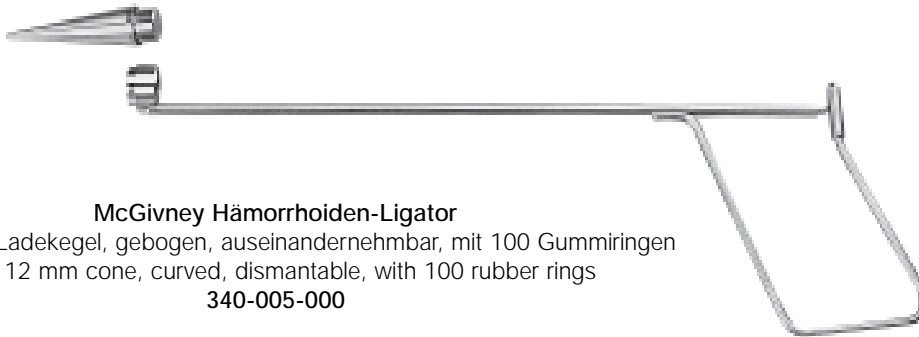

**McGivney Hämorrhoiden-Ligator**  
mit 12 mm Ladekegel, gebogen, auseinandernehmbar, mit 100 Gummiringen  
with 12 mm cone, curved, dismantable, with 100 rubber rings  
340-005-000



**McGivney**  
19.0 cm, 7 1/2"  
340-008-190

**McGivney**  
19.0 cm, 7 1/2"  
340-009-190



**Pratt**  
21.0 cm, 8 1/4"



340-401-210



340-402-210



340-403-210

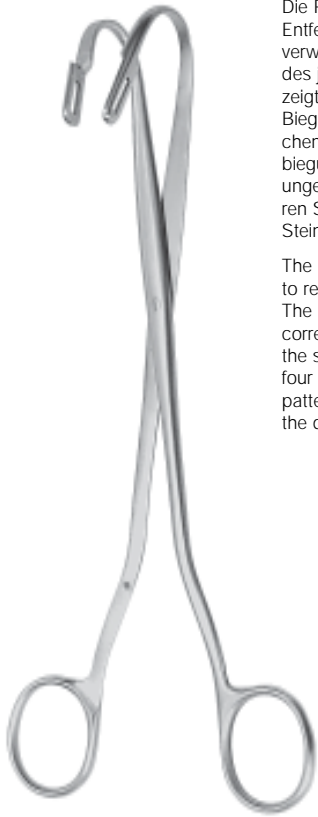

Die Randall-Nierensteinzange wird zum Entfernen von Nierensteinen im Nierenkelch verwendet. Die schematische Darstellung des jeweiligen Instrumentes in der Niere zeigt, wie wichtig die zweckentsprechende Biegung ist, um den richtigen Kelch zu erreichen. Zuzüglich zu den vier Standardbiegungen haben wir noch zwei Neuerungen aufgenommen, welche einen längeren Schaft haben, um auch tiefer sitzende Steine zu erreichen.

The Randall kidney stone forceps are used to remove kidney stones in the kidney cup. The illustration shows, how important the correct angle of the instrument is to remove the stones out of the cup. In addition to the four standard angulations we have two new patterns, with a longer shaft to access to the deeper cups.

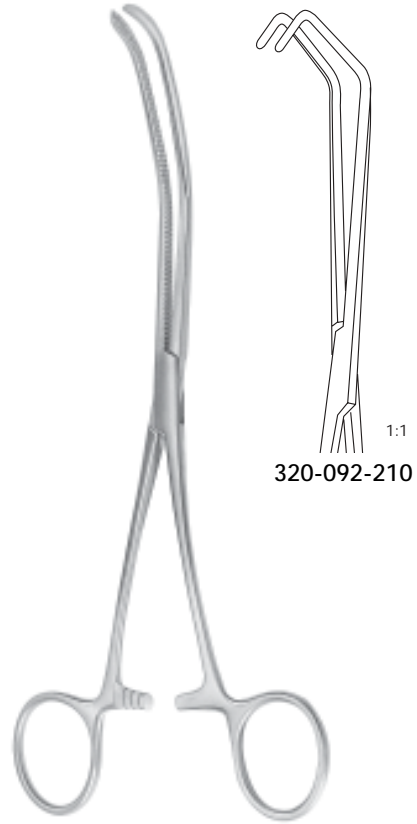

1:1  
320-092-210

Randall	Fig.	
320-101-230	1	23.0 cm, 9"
320-103-220	2	22.0 cm, 8 5/8"
320-105-220	3	22.0 cm, 8 5/8"
320-107-220	4	22.0 cm, 8 5/8"
320-109-190	5	19.0 cm, 7 1/2"
320-111-190	6	19.0 cm, 7 1/2"

Lurz  
21.0 cm, 8 1/4"  
320-090-210

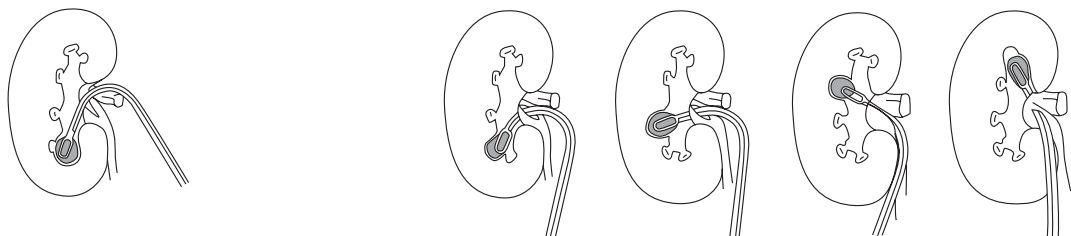
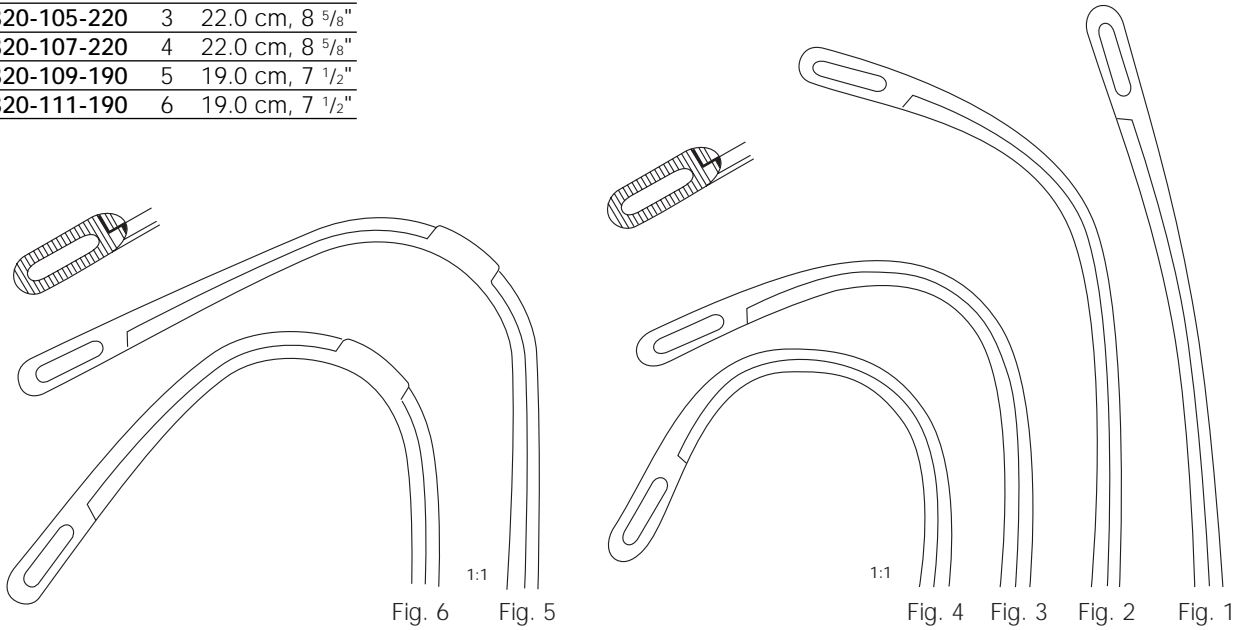



13

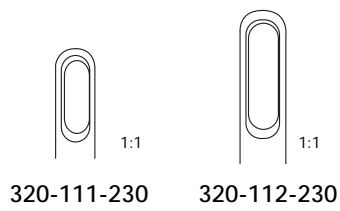

**Desjardins**  
23.0 cm, 9"  
gebogen, curved



**Mayo Blake**  
20.0 cm, 8"  
gebogen, curved  
320-115-200

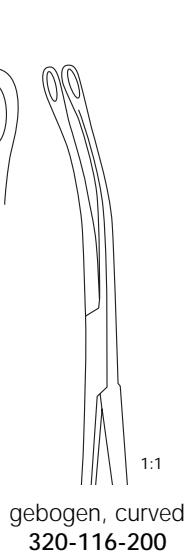

**Blake**  
20.0 cm, 8"  
gerade, straight  
320-117-200



**Mixer**  
22.0 cm, 8 5/8"  
gebogen, curved  
320-119-220

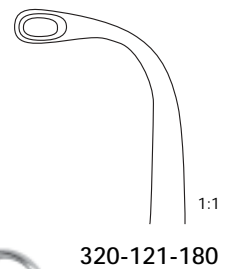
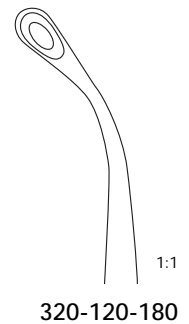

**Turner-Warwick**  
18.0 cm, 7"  
gebogen, curved





**Luer-Körte**  
24.0 cm, 9 1/2"  
biegsam, malleable

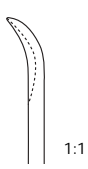

1:1

**Fig. 000**  
2.8 mm  
320-140-300



1:1

**Fig. 00**  
3.4 mm  
320-140-200



1:1

**Fig. 0**  
4.3 mm  
320-140-100



1:1

**Fig. 1**  
5.5 mm  
320-140-010



1:1

**Fig. 2**  
6.7 mm  
320-140-020



1:1

**Fig. 3**  
8.0 mm  
320-140-030



**Fig. 4**  
11.0 mm  
320-140-040



**Fig. 5**  
15.0 mm  
320-140-050



**Sökeland**  
24.0 cm, 9 1/2"  
320-080-240

1:1



**Moore**  
30.0 cm, 12"  
320-145-280



**Czerny**  
24.5 cm, 9 5/8"  
320-135-245



1:1



**Mayo**  
32.0 cm, 12 1/2"  
320-129-320



**Ochsner**  
35.0cm, 13 3/4"  
320-128-350

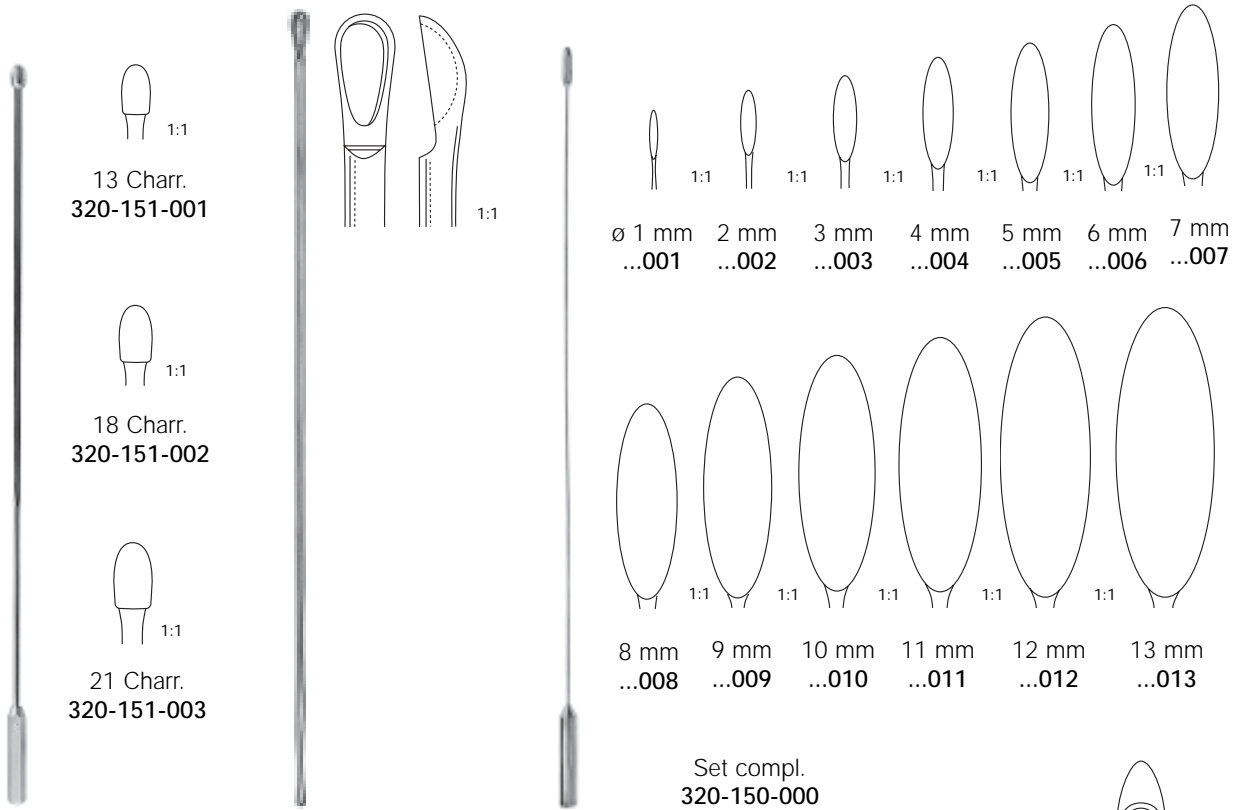

Desjardins  
28.0 cm, 11"

Moynihan  
34.0 cm, 13 3/8"  
320-142-340

Bakes  
30.0 cm, 11 3/4"  
320-150-...

Set compl.  
320-150-000

18 Charr.  
320-121-001



Fergusson  
21.5 cm, 8 1/2"  
320-150-215



Mayo  
27.0 cm, 10 5/8"  
320-152-270

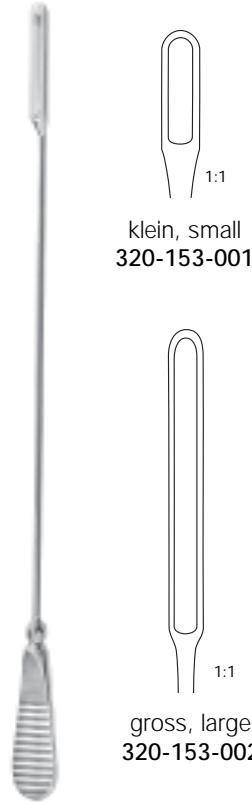

Mayo  
27.0 cm, 10 5/8"  
biegsam, malleable

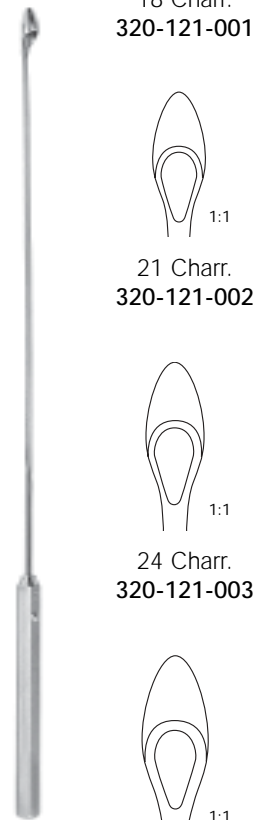

Desjardins  
27 Charr.  
320-121-004



**Thomson-Walker**  
320-190-000

Mittelvalve, allein  
Central blade, only  
105 x 45 mm  
320-185-004



**Millin**  
komplett, complete  
320-185-000

Valve, blade  
57 x 25 mm  
320-185-002

Valve, blade  
82 x 25 mm  
320-185-003

Sperrer allein  
Spreader only  
320-185-001

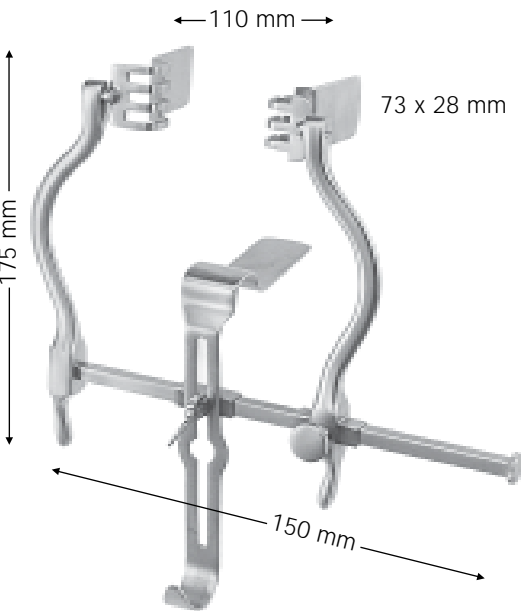

**Judd-Masson**  
320-195-000

105 x 44 mm



**Millin**  
Mittelvalve  
Central blade  
320-195-001

← 95 mm →

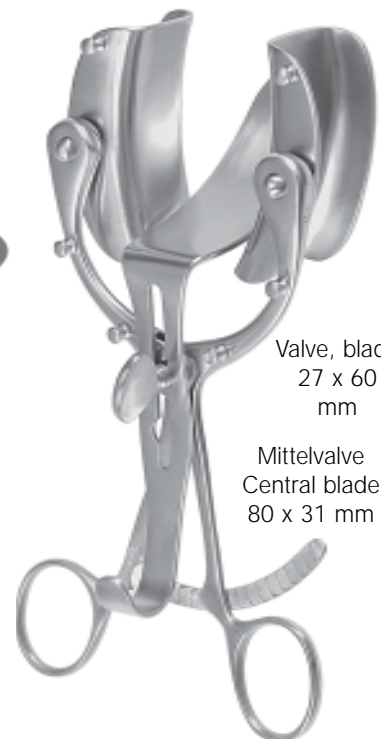

**Legueu**  
320-200-000

Valve, blade  
27 x 60 mm

Mittelvalve  
Central blade  
80 x 31 mm

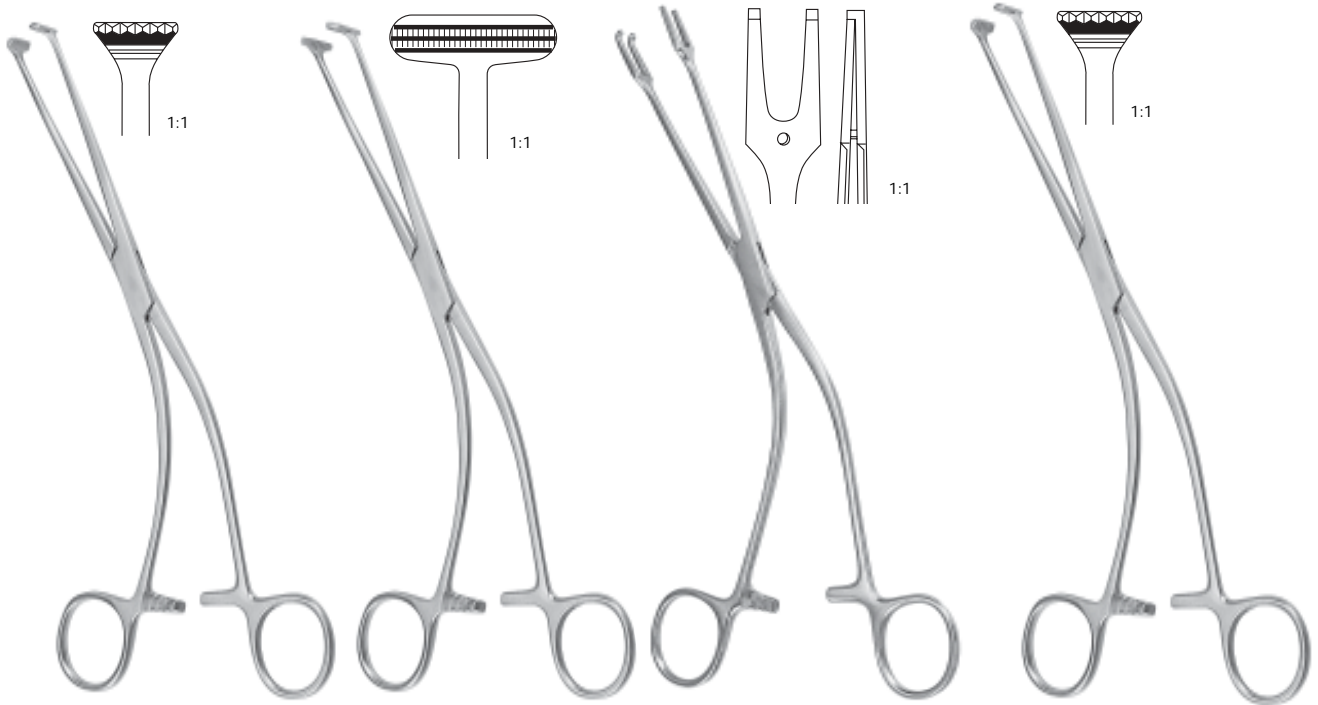

**Millin**  
KapselFaßzange  
Capsule forceps  
23.0 cm, 9"  
320-150-230

**Millin**  
KapselFaßzange  
Capsule forceps  
23.0 cm, 9"  
320-151-230

**Millin**  
Fadenführungs-  
zange  
Ligature carrying  
forceps  
24.5 cm, 9"  
320-151-245

**Millin**  
Faßzange-vordere  
Lappen  
Lobe Holding  
Forceps,  
9 x 9 Zähne, teeth  
320-152-230

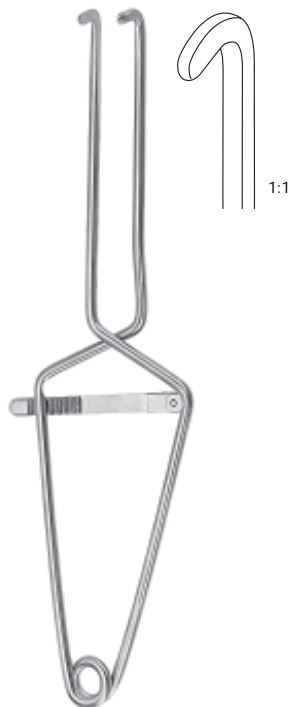

**Millin**  
Blasenhalssperr-  
er  
Bladder Neck  
Spreader  
28.5 cm, 11 1/4"  
320-165-285



**Mathieu**  
Fremdkörperzange  
Foreign body  
forceps  
19.0 cm, 7 1/2"  
320-350-190  
28.0 cm, 11"  
320-350-280

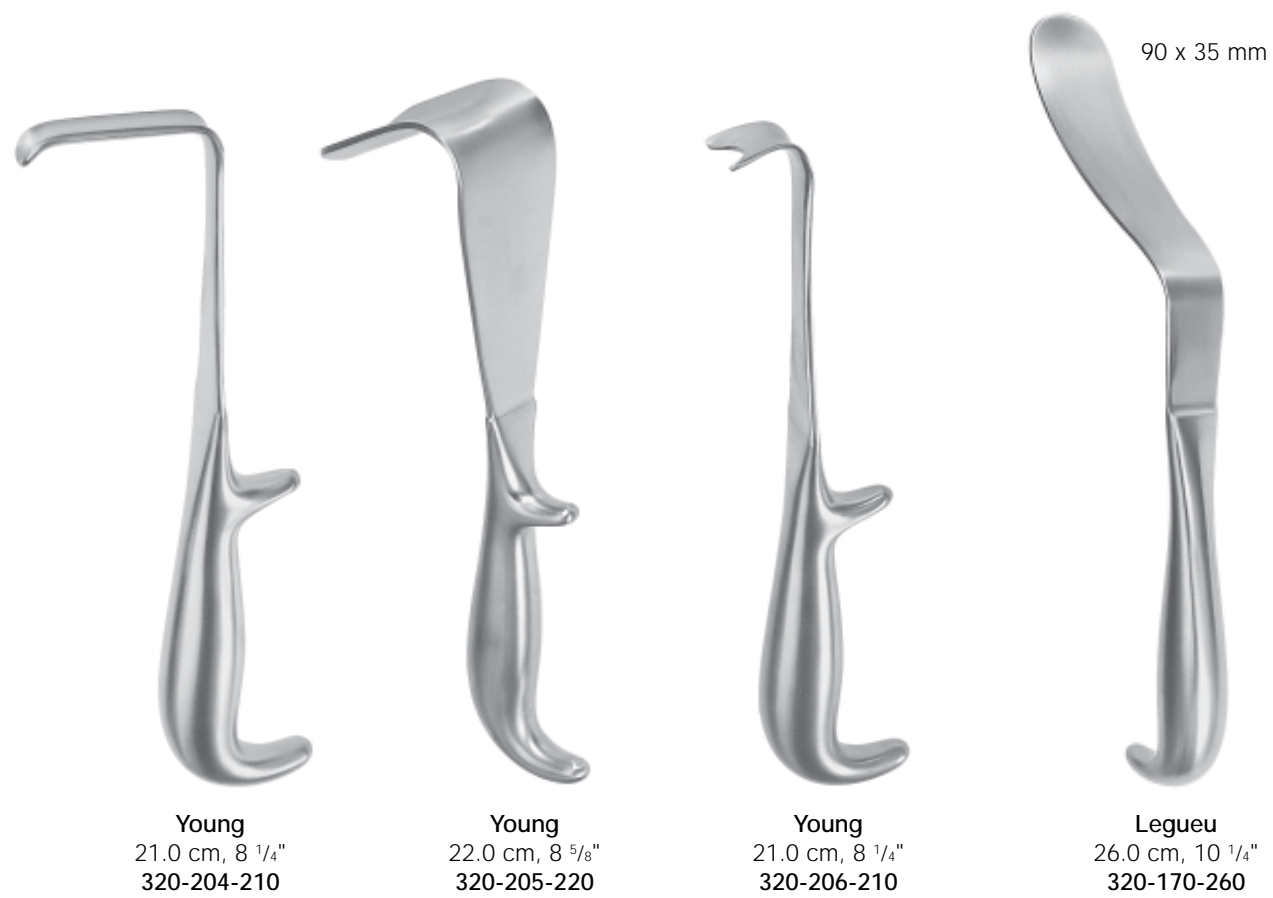

**Young**  
 21.0 cm, 8 1/4"  
 320-204-210

**Young**  
 22.0 cm, 8 5/8"  
 320-205-220

**Young**  
 21.0 cm, 8 1/4"  
 320-206-210

**Legueu**  
 26.0 cm, 10 1/4"  
 320-170-260



90 x 61 mm

**Kocher**  
 23.5 cm, 9 1/4"  
 320-175-235



**Katheter, Männer**  
 Catheter, male  
 29.0 cm, 11 1/2"

	Charr.
320-720-080	8
320-720-100	10
320-720-120	12
320-720-140	14
320-720-160	16
320-720-180	18
320-720-200	20
320-720-220	22
320-720-240	24



**Strauss**  
 13.0 cm, 5 1/8"  
 320-999-000



**Stockmann**  
 8.0 cm, 3 1/4"  
 320-998-000

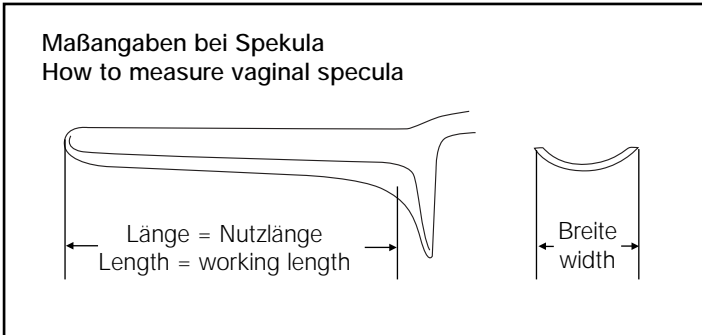

**Collin**  
für Kinder, for children  
65 x 10 mm  
350-009-001



**Collin**  
für Jungfrauen, for virgins  
65 x 20 mm  
350-110-001



Collin	Fig.	mm
350-110-002	1	85 x 30
350-110-003	2	100 x 35
350-110-004	3	110 x 40

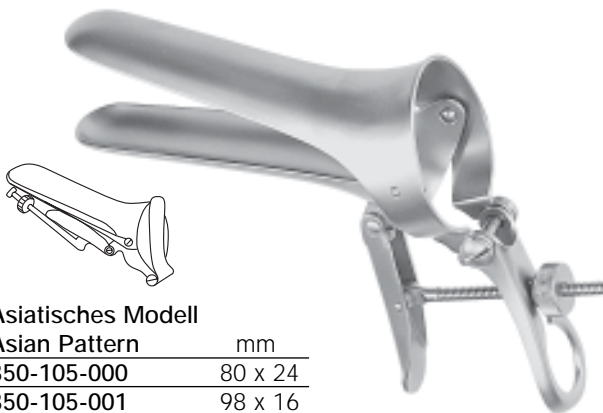

Asiatisches Modell  
Asian Pattern

	mm
350-105-000	80 x 24
350-105-001	98 x 16
350-105-002	105 x 25
350-105-003	107 x 29
350-105-004	115 x 35
350-105-006	80 x 32

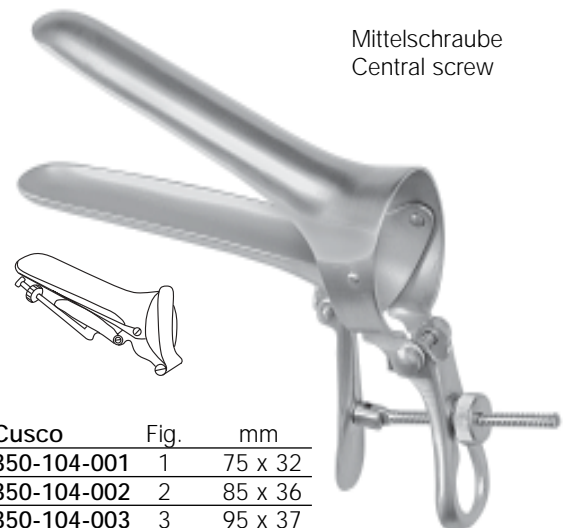

Mittelschraube  
Central screw

Cusco	Fig.	mm
350-104-001	1	75 x 32
350-104-002	2	85 x 36
350-104-003	3	95 x 37



Seitl. Schraube  
Lateral screw

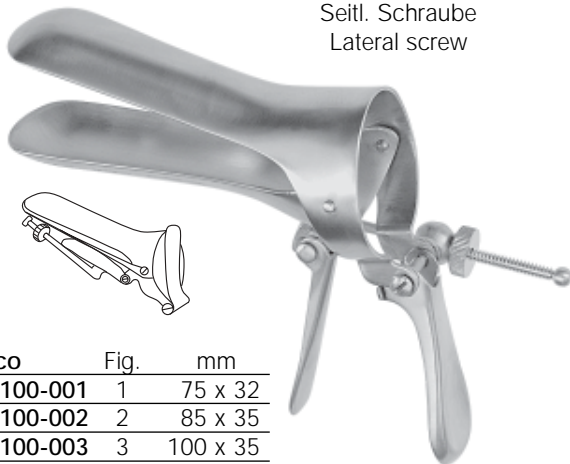

Cusco	Fig.	mm
350-100-001	1	75 x 32
350-100-002	2	85 x 35
350-100-003	3	100 x 35

Schweizer Modell  
Swiss Pattern

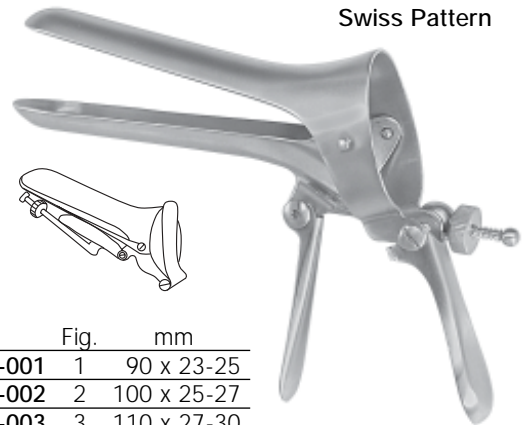

Cusco	Fig.	mm
350-102-001	1	90 x 23-25
350-102-002	2	100 x 25-27
350-102-003	3	110 x 27-30



Cusco  
75 x 17 mm  
350-103-000

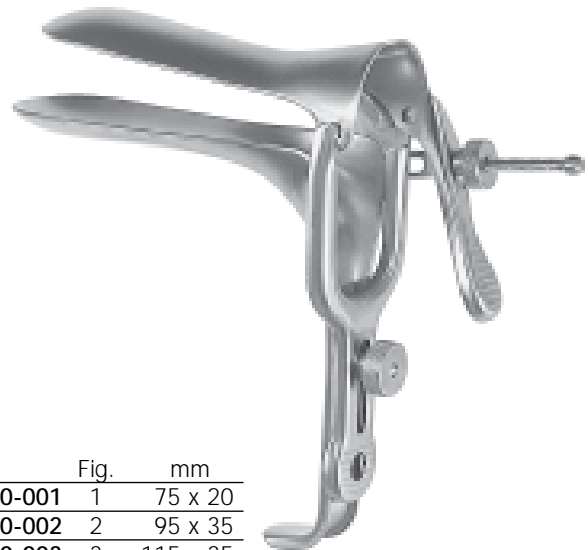

Grave	Fig.	mm
350-130-001	1	75 x 20
350-130-002	2	95 x 35
350-130-003	3	115 x 35



Pederson	Fig.	mm
350-140-001	1	75 x 13
350-140-002	2	100 x 22
350-140-003	3	120 x 25



Semm	mm
350-120-001	100 x 17-20
350-120-002	100 x 25-30



**Weissbarth**  
21.0 cm, 8 1/4"  
80 x 42 mm  
330-312-000

mit abnehmbarem  
Auffangsieb,  
with removable strainer



mit abnehmbarem  
Gewicht 1.14 Kg.  
with removable weight 1.14 Kg  
75 x 38 mm  
350-310-000

mit festem Gewicht 1.4 Kg  
with fixed weight 1.4 Kg  
105 x 38 mm  
350-311-000

**Auvard**  
24.0cm, 9 1/2"

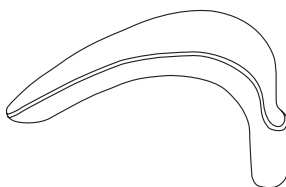

80 x 30 mm  
330-301-001

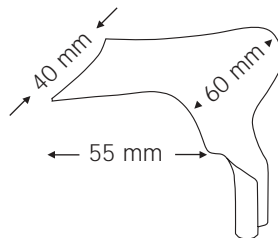

55 x 40-60 mm  
330-301-004

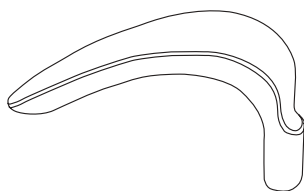

85 x 35 mm  
330-301-002

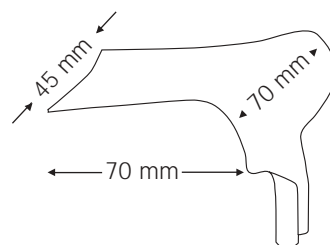

70 x 45-70 mm  
330-301-005

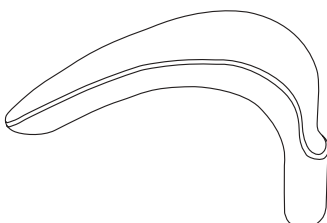

85 x 40 mm  
330-301-003



**Scherback**  
komplettes Set bestehend aus:  
complete Set containing:  
350-301-001, 350-301-002,  
350-301-003, 350-301-004,  
350-301-005, 350-303-000,  
350-303-000  
350-300-000

Gewicht, weight (400 g)  
350-302-001

Gewicht, weight (800 g)  
350-302-002

Scherback Griff, allein  
Scherback handle, only  
350-303-000

15





Spekula, Specula

Kristeller	Fig.	mm
350-230-001	1	105 x 26
350-230-002	2	105 x 28
350-230-003	3	105 x 33



Halter, Retractor

Kristeller	Fig.	mm
350-231-001	1	115 x 22
350-231-002	2	115 x 24
350-231-003	3	115 x 29



Satz, Set

Kristeller	Fig.
350-232-001	1
350-232-002	2
350-232-003	3



Spekula, Specula

Kristeller	Fig.	mm
350-240-001	1	105 x 27
350-240-002	2	105 x 30
350-240-003	3	105 x 36



Halter, Retractor

Kristeller	Fig.	mm
350-241-001	1	105 x 23
350-241-002	2	105 x 26
350-241-003	3	105 x 32



Satz, Set

Kristeller	Fig.
350-250-001	1
350-250-002	2
350-250-003	3



Spekula, Specula

Kristeller	Fig.	mm
350-210-000	0	70 x 15
350-210-001	1	70 x 27
350-210-002	2	80 x 30
350-210-003	3	90 x 36



Halter, Retractor

Kristeller	Fig.	mm
350-211-000	0	70 x 10
350-211-001	1	75 x 23
350-211-002	2	85 x 26
350-211-003	3	100 x 32



Satz, Set

Kristeller	Fig.
350-212-000	0
350-212-001	1
350-212-002	2
350-212-003	3



Spekula, Specula

Kristeller	mm
350-220-001	105 x 18
350-220-002	105 x 21



Halter, Retractor

Kristeller	mm
350-221-001	110 x 14
350-221-002	115 x 17



Satz, Set

Kristeller	Fig.
350-222-001	1
350-222-002	2

15



70 x 15 mm

**Kristeller**  
17.0 cm, 6 3/4"  
350-215-000



75 x 39 mm

**Kallmorgen**  
17.0 cm, 6 3/4"  
350-270-000



Spekulum, Specula	
<b>Kallmorgen</b>	mm
350-270-001	70 x 40
350-270-002	90 x 40



Halter, Retractor	
<b>Kallmorgen</b>	mm
350-271-001	70 x 33
350-271-002	90 x 33



Satz, Set	
<b>Kallmorgen</b>	Fig.
350-272-001	1
350-272-002	2



Jackson	Fig.	mm
350-206-001	1	75 x 38
350-206-002	2	90 x 38
350-206-003	3	100 x 38



Breisky	Fig.
350-190-001	1
350-190-002	2
350-190-003	3



Sims	Fig.
350-200-001	1
350-200-002	2
350-200-003	3

350-200-004 Satz, set

15

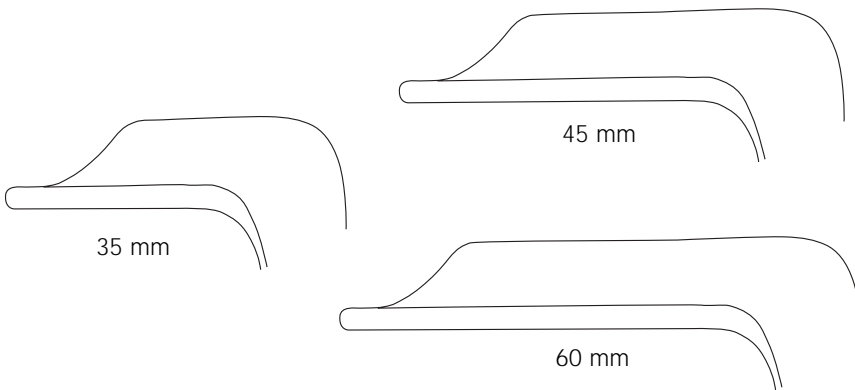

**Doyen**  
leicht hohl, slightly-concave

	Fig.	mm
350-290-001	1	55 x 35
350-290-002	2	85 x 35
350-290-003	3	115 x 35
350-290-004	1	55 x 45
350-290-005	2	85 x 45
350-290-006	3	115 x 45
350-290-007	4	160 x 45
350-290-008	1	55 x 60
350-290-009	2	85 x 60
350-290-010	3	115 x 60
350-290-011	4	160 x 60

**Doyen**  
halbhohl, medium-concave

	mm
350-291-001	90 x 35
350-291-002	120 x 35
350-291-003	60 x 45
350-291-004	90 x 45
350-291-005	120 x 45
350-291-006	60 x 60
350-291-007	90 x 60
350-291-008	120 x 60





Breisky	mm
350-320-020	100 x 20
350-320-025	100 x 25
350-320-030	100 x 30
350-320-035	100 x 35
350-320-040	100 x 40
350-322-020	130 x 20
350-322-025	130 x 25
350-322-030	130 x 30
350-322-035	130 x 35
350-322-040	130 x 40
350-324-040	155 x 40



Landau	mm
350-330-001	100 x 28
350-330-002	100 x 38



Spekula, Specula	
Mathieu	Fig.
350-281-001	1
350-281-002	2



Halter, Retractor	
Mathieu	Fig.
350-282-001	1
350-282-002	2



**Matzenauer**  
leicht hohl, slightly-concave  
27.0-31.0 cm, 10 5/8"-12 1/4"  
mm

350-293-020	90 x 20
350-294-010	100 x 10
350-294-015	100 x 15
350-294-020	100 x 20
350-294-025	100 x 25
350-295-015	125 x 15
350-295-020	125 x 20
350-295-025	125 x 25
350-295-030	125 x 30
350-295-035	125 x 35
350-295-040	125 x 40



85 x 17 mm

Braun, modif.  
19.0 cm, 7 1/2"  
350-267-001



**Doyen**  
seitliches Spekulum  
lateral speculum  
23.0 cm, 9"  
350-295-001



**Doyen**  
seitliches Spekulum  
lateral speculum  
25.0 cm, 9 3/4"  
350-295-002



**Wertheim**  
30.0 cm, 12"  
350-332-000



**Kogan**  
mit Schraubengriff (SH),  
with screw handle (SH)  
24.0 cm, 9 1/2"



**Kogan**  
mit Daumensperre (RH),  
with thumb ratchet (RH)  
24.0 cm, 9 1/2"

SH 350-361-001  
RH 350-362-001



SH 350-361-002  
RH 350-362-002



SH 350-361-003  
RH 350-362-003



Skalensperre mit  
Fixierschrauben.  
Scale ratchet  
with fixing screws.

15



RZ Lateral Retraktor  
350-340-000

Jeder Gynäkologe hat bereits die Erfahrung gemacht, den Gebärmutterhals zu beobachten trotz eines Kollapses der seitlichen Vagina-Wände. Einige Ärzte haben sogar versucht Zungendrucker und Kondome, die Sie über das Spekulum stülpen, zu benutzen um die Wand zurückgezogen zu halten. Jetzt endlich gibt es eine Lösung des Problems.

RZ-Medizintechnik bietet einen seitlichen Vagina-Re retraktor an, der in Ihr Spekulum paßt. Der seitliche Retraktor verringert oder eliminiert sogar den Kollaps der Vagina-Wände im Blickfeld um einen totalen Einblick in den Muttermund zu gewährleisten. Dies ist ein unschätzbare Vorteil bei einer Gebärmutterhals-Untersuchung, einer Kolpophotographie und verschiedenen Laser- sowie HF-Chirurgie-Eingriffen. Der Retraktor hat auch einen Sperrenmechanismus, der ein einfaches Öffnen und Schließen erlaubt.

Every gynecologist has experienced the problem of trying to view a patient's cervix despite the collapse of the lateral vaginal walls. Some have even resorted to using tongue depressors or condoms over their speculum to try to keep the walls retracted. Finally there's a convenient way to solve this problem.

RZ-Medizintechnik introduces the lateral vaginal retractor, a vaginal spreader that fits inside your speculum. The lateral vaginal retractor reduces or eliminates the collapse of the vaginal walls into the field of view, providing complete visualization when examining the cervix. It is invaluable for gaining a wider field of view, when performing cervicography, colpophotography, laser or electrosurgery procedures. It also features a convenient locking mechanism with a thumb-ratchet release that keeps it open and in place.

Die Cohen Uterus Sonde wird zur Manipulation des Uterus verwendet. Eine federnde Zangenhalterung garantiert, daß die Sonde zusammen mit einer Hakenzange verwendet werden kann.

The Cohen Uterine Cannula is used for manipulating the uterus. A spring-loaded fixation guarantees, that the cannula can be used together with a tenaculum forceps.

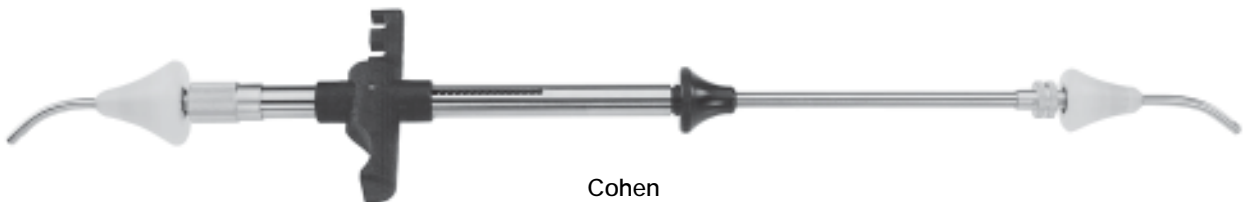

Cohen  
Sonde  
Self Retaining Cannula  
350-750-000

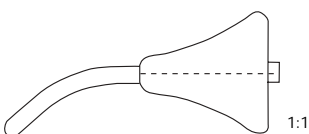

Portio Adapter  
groß, large  
350-750-002

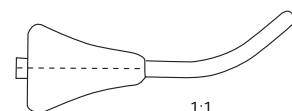

Portio Adapter  
klein, small  
350-750-001



Diese lange Tenaculum Faßzange gewährt größte Muttermund-Stabilität, bedingt durch die beiden langen Haken.

This tenaculum forceps provides maximum cervical stabilization through its two opposing hooks.

autoklavierbar, autoclavable



**RZ-Hakenzange**  
**RZ-tenaculum forceps**  
1 x 1 beschichteter Zahn, coated tooth  
gerade, straight  
24.0 cm, 9 1/2"  
350-401-250

Zum Entfernen von abgetrennten Gewebeprobe im Vaginalkanal

To remove the looped tissue sample in the vaginal canal



**RZ-Ringfaßzange**  
**RZ-ring forceps**  
beschichtetes, ringförmiges Maul  
coated, ringshaped jaw  
gerade, straight  
24.0 cm, 9 1/2"  
150-150-250

15

Graves Vaginal Spekulum, beschichtet, mit Absaugkanal  
Graves vagina speculum, coated, with smoke evacuation tube



Graves		
Fig. 1	75 x 20 mm	350-131-001
Fig. 2	95 x 35 mm	350-131-002
Fig. 3	115 x 35 mm	350-131-003





Zum Ziehen des Gewebes und damit zum leichteren Schneiden und Manipulieren.  
For stretching of tissue and for easier cutting and manipulation.

autoklavierbar, autoclavable



25.0 cm, 9 3/4"

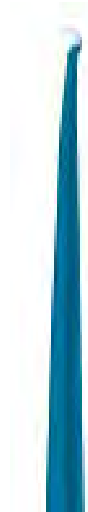

**RZ-Iris**  
Haken, hook  
beschichtet, coated  
350-770-250

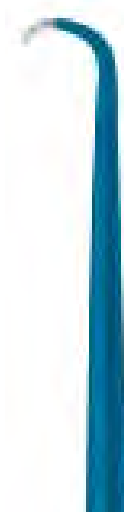

**RZ-Emmett**  
Tenaculum Haken,  
tenaculum hook  
beschichtet, coated  
350-767-240



**RZ-Zweier**  
Zweierhaken, two-prong-hook  
beschichtet, coated  
350-768-240



**RZ-Dreier**  
Dreierhaken, three-prong-hook  
beschichtet, coated  
350-769-240



**Hegar**

mit Muldengriff

sloped handle

	∅
350-380-010	1.0 mm
350-380-015	1.5 mm
350-380-020	2.0 mm
350-380-025	2.5 mm
350-380-030	3.0 mm
350-380-035	3.5 mm
350-380-040	4.0 mm
350-380-045	4.5 mm
350-380-050	5.0 mm
350-380-055	5.5 mm
350-380-060	6.0 mm
350-380-065	6.5 mm
350-380-070	7.0 mm
350-380-075	7.5 mm
350-380-080	8.0 mm
350-380-085	8.5 mm
350-380-090	9.0 mm
350-380-095	9.5 mm

	∅
350-380-100	10.0 mm
350-380-105	10.5 mm
350-380-110	11.0 mm
350-380-115	11.5 mm
350-380-120	12.0 mm
350-380-125	12.5 mm
350-380-130	13.0 mm
350-380-135	13.5 mm
350-380-140	14.0 mm
350-380-145	14.5 mm
350-380-150	15.0 mm
350-380-155	15.5 mm
350-380-160	16.0 mm
350-380-165	16.5 mm
350-380-170	17.0 mm

15



**Hegar**

Satz mit 14 Dilatoren

Set of 14 dilators

∅ 4, 5, 6, 7, 8, 9, 10, 11, 12,  
13, 14, 15, 16, 17 mm

im Metalletui mit Scharnierdeckel  
in metal case with hinged lid

350-381-001



**Hegar**

mit konischer Spitze,  
doppelendig

With conical point,  
double-ended

	Ø
<u>350-382-020</u>	<u>1.0 / 2.0 mm</u>
<u>350-382-040</u>	<u>3.0 / 4.0 mm</u>
<u>350-382-060</u>	<u>5.0 / 6.0 mm</u>
<u>350-382-080</u>	<u>7.0 / 8.0 mm</u>
<u>350-382-100</u>	<u>9.0 / 10.0 mm</u>
<u>350-382-120</u>	<u>11.0 / 12.0 mm</u>
<u>350-382-140</u>	<u>13.0 / 14.0 mm</u>
<u>350-382-160</u>	<u>15.0 / 16.0 mm</u>
<u>350-382-180</u>	<u>17.0 / 18.0 mm</u>
<u>350-382-200</u>	<u>19.0 / 20.0 mm</u>
<u>350-382-220</u>	<u>21.0 / 22.0 mm</u>
<u>350-382-240</u>	<u>23.0 / 24.0 mm</u>
<u>350-382-260</u>	<u>25.0 / 26.0 mm</u>



**Hegar**

Satz mit 8 Dilatoren  
Set of 8 dilator

Ø  $\frac{3}{4}$ - $\frac{17}{18}$  mm

in auskochbarer Stoff-Rolltasche  
in boilable canvas roll

350-383-001



**Hank**

mit konischer Spitze,  
doppelendig, amerikanische Größen  
With conical point, double-ended,  
american scale Fig.            ∅

<b>350-390-010</b>	9/10	4.5 / 5.0 mm
<b>350-390-012</b>	11/12	5.5 / 6.0 mm
<b>350-390-014</b>	13/14	6.5 / 7.0 mm
<b>350-390-016</b>	15/16	7.5 / 8.0 mm
<b>350-390-018</b>	17/18	8.5 / 9.0 mm
<b>350-390-020</b>	19/20	9.5 / 10.0 mm



**Hank**

Satz mit 6 Stück in Stoff-Rolltasche  
Set of 6 pieces on canvas roll  
**350-391-002**



**Pratt**

französische Größen  
French scale 10 <sup>3</sup>/<sub>8</sub>"

<b>350-392-015</b>	13-15
<b>350-392-019</b>	17-19
<b>350-392-023</b>	21-23
<b>350-392-027</b>	25-27
<b>350-392-031</b>	29-31
<b>350-392-035</b>	33-35
<b>350-392-039</b>	37-39
<b>350-392-043</b>	41-43



**Pratt**

Satz mit 8 Stück in Stoff-Rolltasche  
Set of 8 pieces on canvas roll  
**350-392-000**

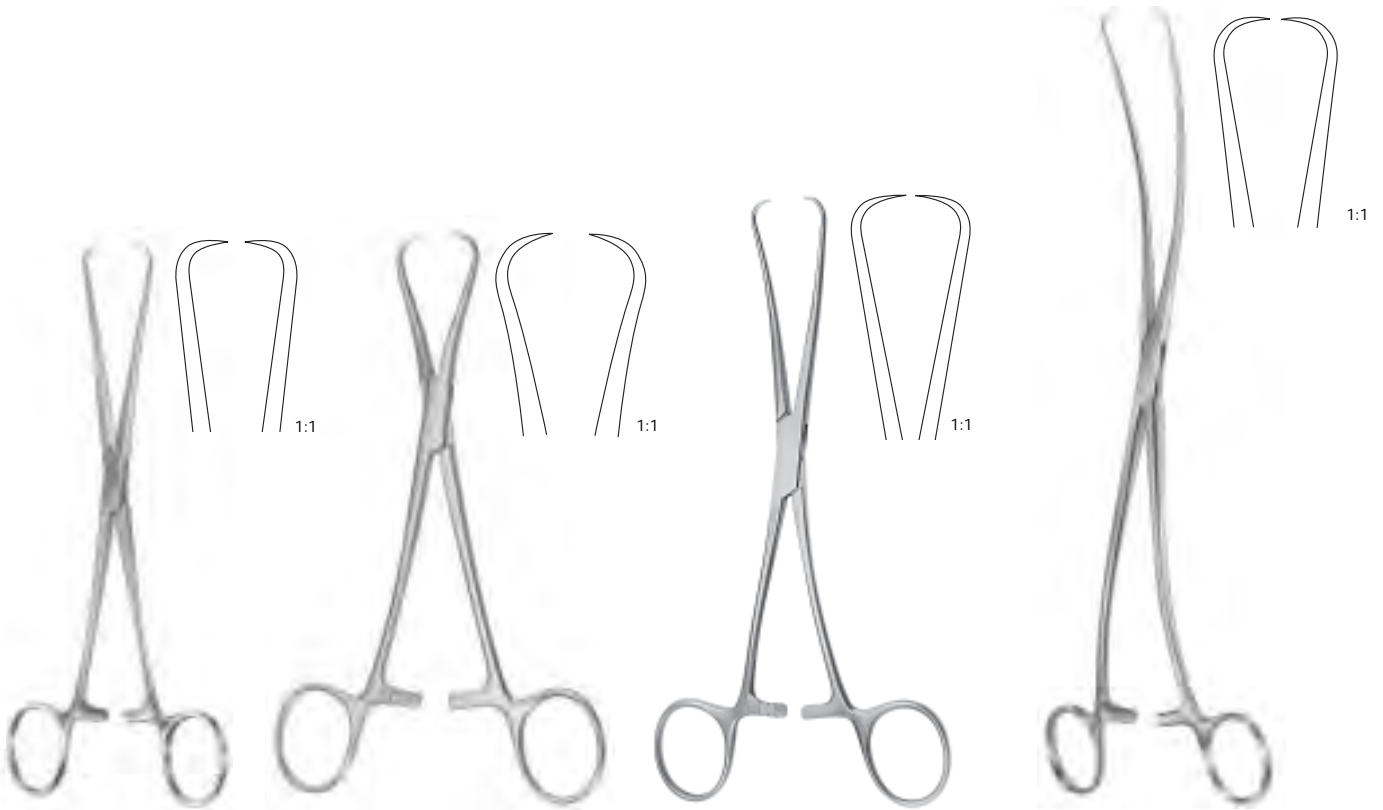

**Barrett**  
18.0 cm, 7"  
350-426-180

**Adair**  
19.0 cm, 7 1/2"  
350-426-190

**Jarcho**  
20.0 cm, 8"  
350-427-200

**Duplay**  
28.0 cm, 11"  
350-428-280

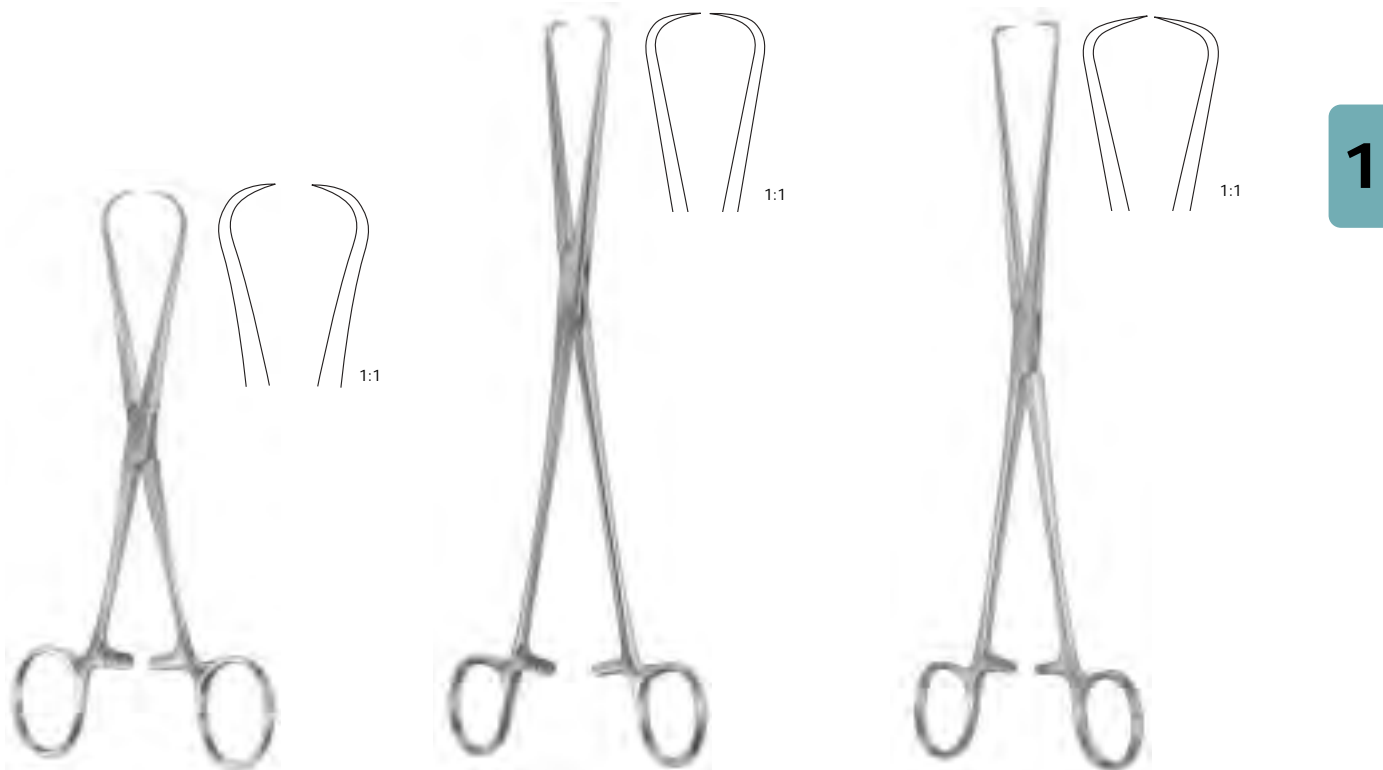

**Staude-Moore**  
17.0 cm, 6 3/4"  
350-422-170

**Schroeder**  
25.0 cm, 9 3/4"  
350-400-250

**Braun**  
25.0 cm, 9 3/4"  
350-410-250

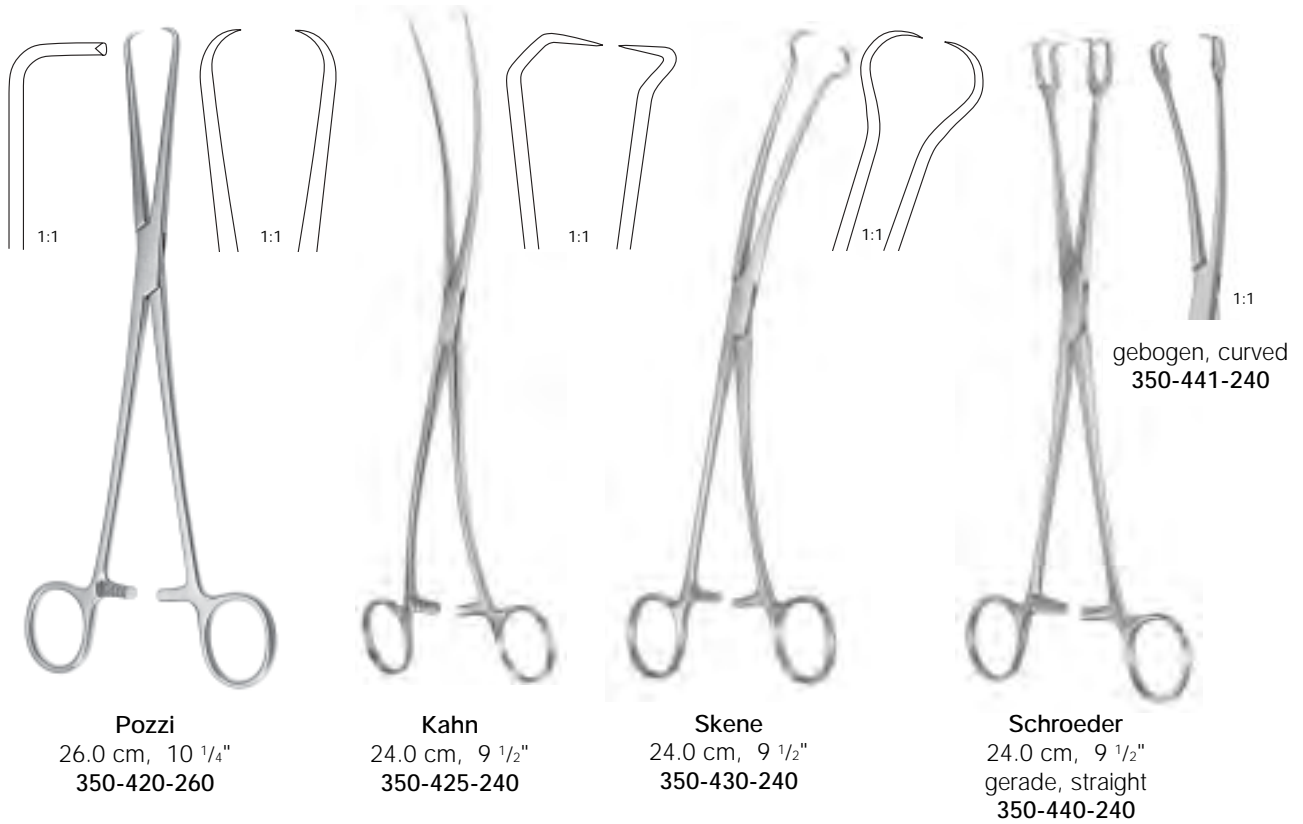

Hakenzangen  
Vulsellum forceps

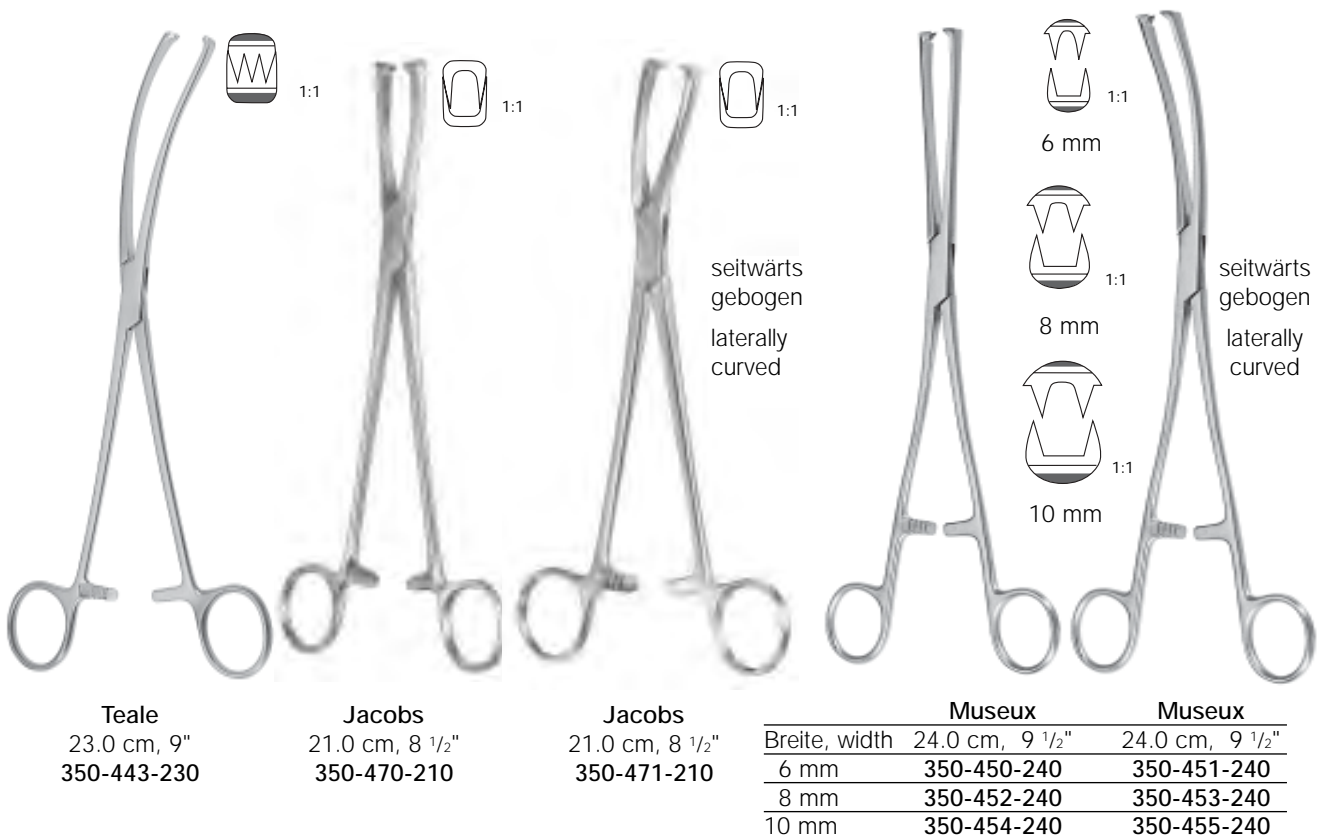

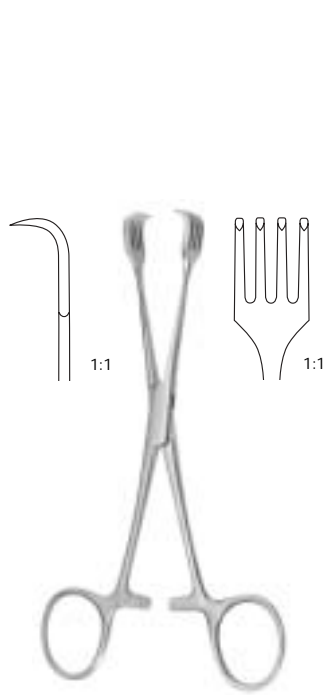

**Braun**  
15.5 cm, 6"  
350-476-155

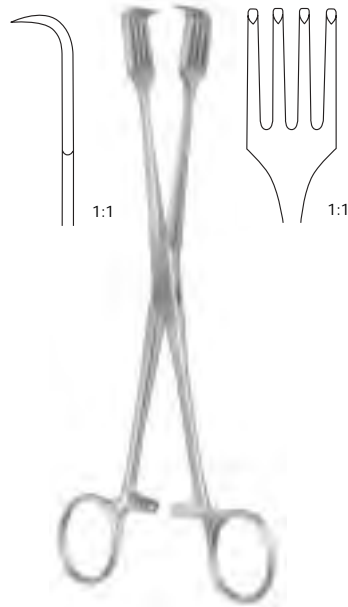

**Czerny**  
20.5 cm, 8"  
350-480-205

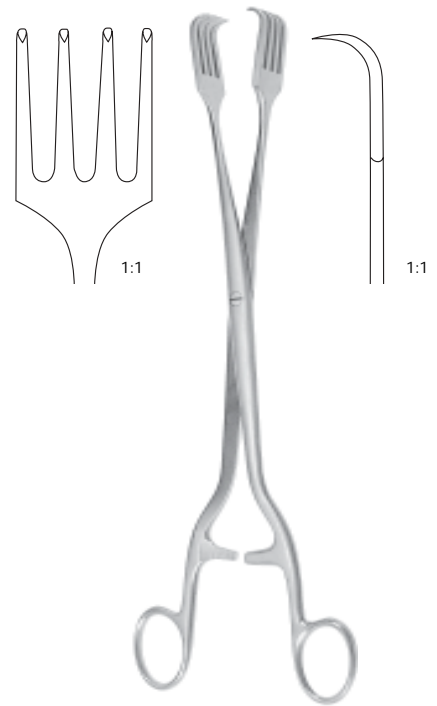

**Pratt**  
26.0 cm, 10 1/4"  
350-474-260

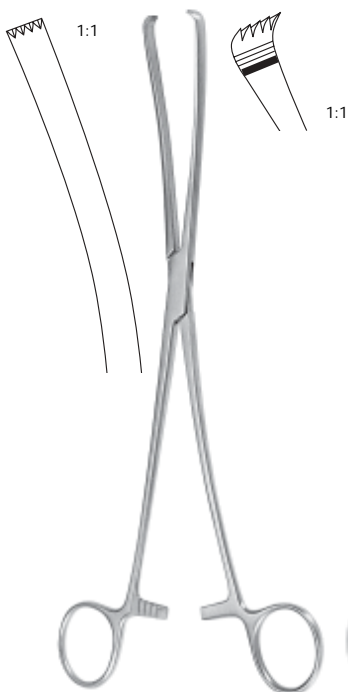

**Iowa**  
26.0 cm, 10 1/4"  
350-445-260

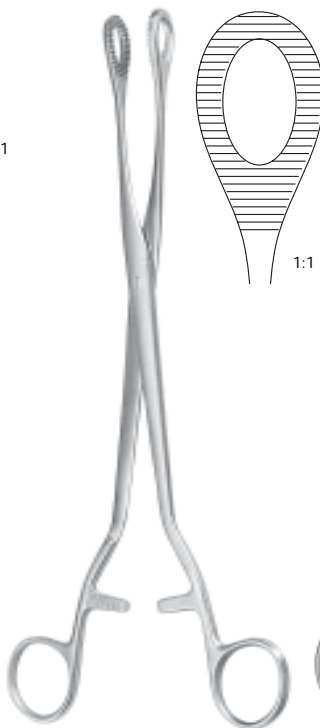

**Noto**  
27.0 cm, 10 5/8"  
350-492-270

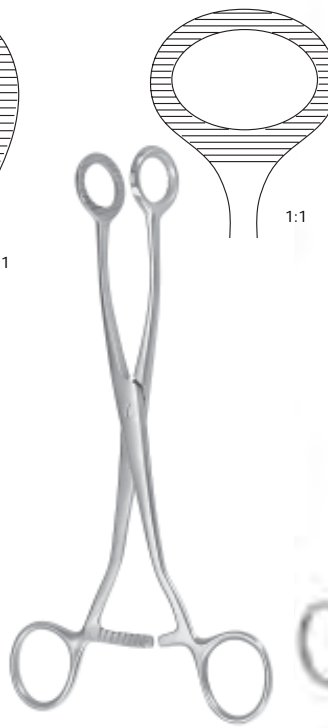

**Doyen**  
20.0 cm, 8"  
350-494-200

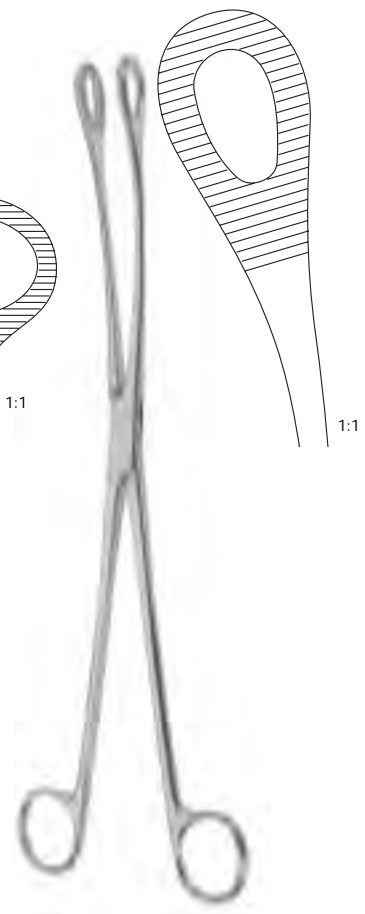

**Kelly**  
32.0 cm, 12 1/2"  
350-490-320

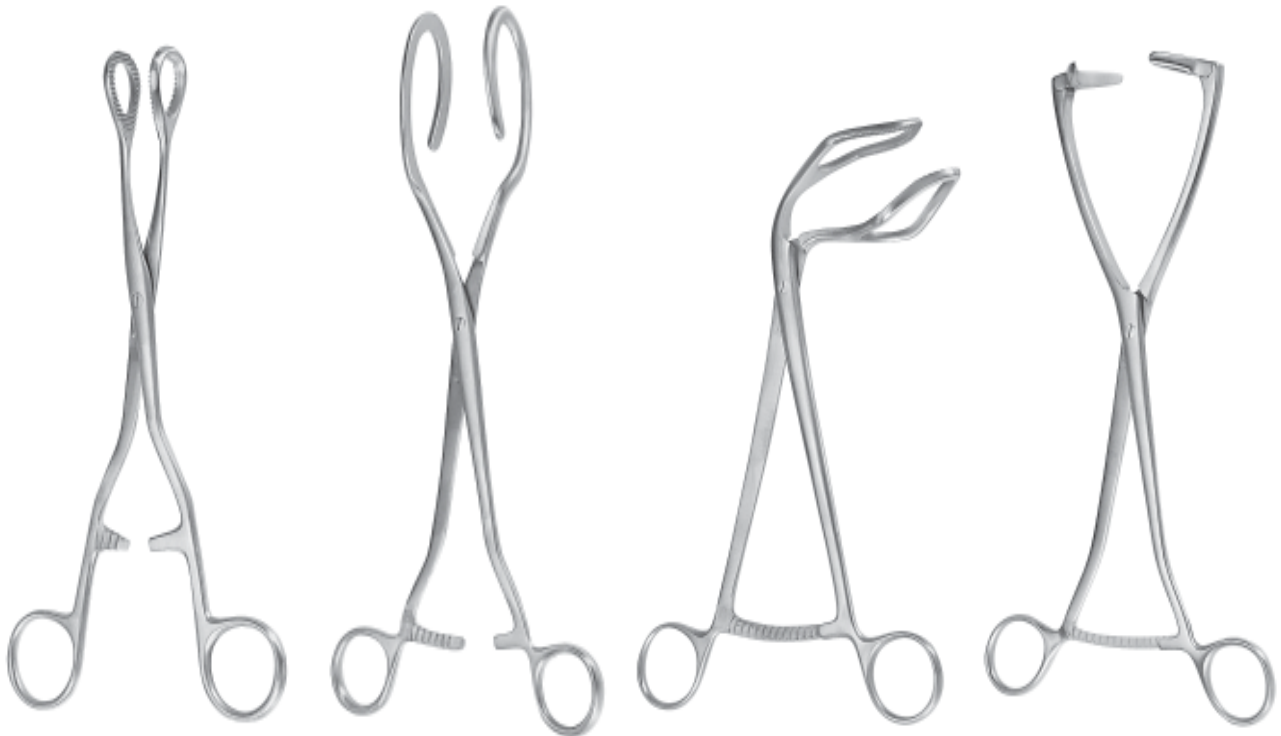

**Heywood-Smith**  
25.0 cm, 9 3/4"  
350-491-250

**Dartigues**  
27.0 cm, 10 3/4"  
350-493-270

**Somer**  
23.0 cm, 9"  
350-493-230

**Collin**  
25.0 cm, 9 3/4"  
350-493-250

Amniotom  
Amniotome

Uterus-Depressor  
Uterine depressor

Katheter  
Catheter



**Beacham**  
26.0 cm, 10 1/4"  
350-429-260



**Braun**  
28.0 cm, 11"  
350-399-280



Metalkatheter für Frauen  
Female catheters, metal

16.0 cm, 6 1/4"	Charr.
320-721-060	6
320-721-070	7
320-721-080	8
320-721-090	9
320-721-100	10
320-721-110	11
320-721-120	12
320-721-130	13
320-721-140	14
320-721-150	15
320-721-160	16
320-721-180	18
320-721-200	20

15





**Sims**  
32.0 cm, 12 1/2"  
starr, rigid  
350-395-320

biegsam, malleable  
350-396-320



**Martin**  
32.0 cm, 12 1/2"  
starr, rigid  
350-393-320

biegsam, malleable  
350-394-320



**Valleix**  
350-398-250



ø 4 mm

**Simpson**  
29.0 cm, 11 1/2"  
biegsam, malleable  
350-396-290



ø 4 mm

**Collin**  
28.0 cm, 11"  
350-392-280



**Kevorkian**  
30.0 cm, 12"



1:1

biegsam, malleable  
mit Korb, with basket  
350-601-300



1:1

starr, rigid  
mit Korb, with basket  
350-600-300



1:1

starr, rigid  
ohne Korb, without basket  
350-599-300



**Novak**  
23.0 cm, 9"  
ø 4 mm  
350-604-230

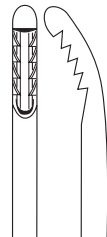

1:1



**Randall**  
24.0 cm, 9 1/2"  
ø 4 mm  
350-602-240



1:1



**Milan**  
29.0 cm, 11 1/2"  
starr, rigid  
350-605-007  
biegsam, malleable  
350-607-007

ø 7 mm



Ringgriff, ring handle  
biegsam, malleable  
25.0 cm, 9 3/4"  
350-766-001



Rundgriff, round handle  
biegsam, malleable  
25.0 cm, 9 3/4"  
350-766-100



Emmett  
22.0 cm, 8 5/8"



Fig. 1  
350-765-001



Fig. 2  
350-765-002



Fig. 3  
350-765-003



Simon  
22.0 cm, 8 5/8"  
350-766-220

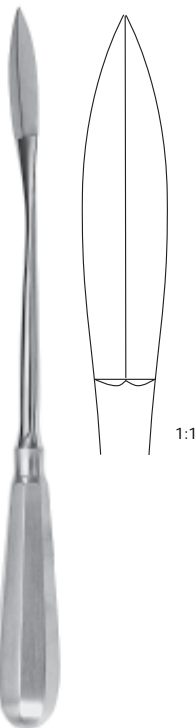

Segond  
27.0 cm, 10 5/8"  
350-800-000

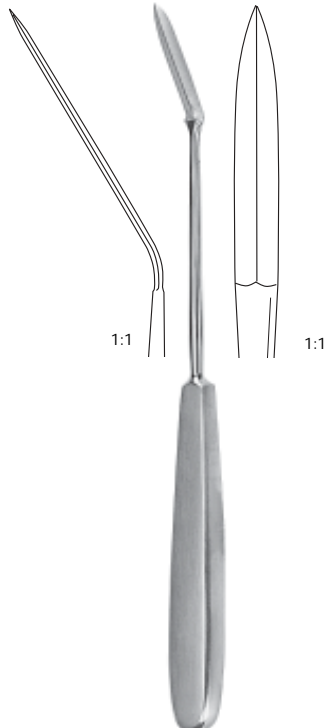

Ayre  
23.0 cm, 9"  
350-810-000



Doyen  
19.0 cm, 7 1/2"  
350-757-190



Doyen  
17.0 cm, 6 3/4"  
350-759-170

15



**Sims**  
28.5 cm, 11 1/4"

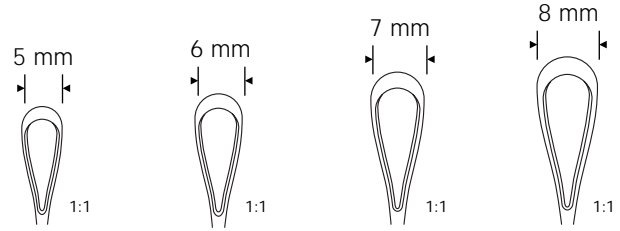

	Fig. 00	Fig. 0	Fig. 1	Fig. 2
fest - scharf, rigid - sharp	350-630-005	350-630-006	350-630-007	350-630-008
fest - stumpf, rigid - blunt	350-926-050	350-926-060	350-926-070	350-926-080
biegsam - scharf, malleable - sharp	350-631-005	350-631-006	350-631-007	350-631-008
biegsam - stumpf, malleable - blunt	350-927-050	350-927-060	350-927-070	350-927-080

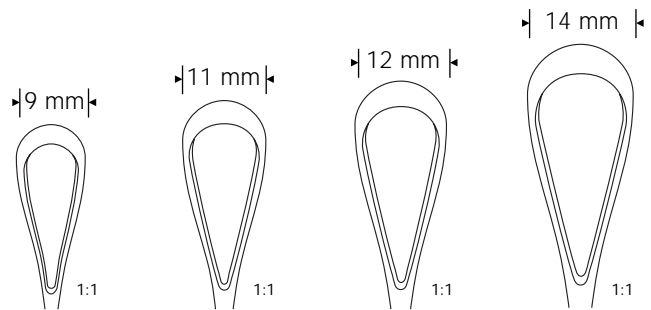

	Fig. 3	Fig. 4	Fig. 5	Fig. 6
fest - scharf, rigid - sharp	350-630-009	350-630-011	350-630-012	350-630-014
fest - stumpf, rigid - blunt	350-926-090	350-926-110	350-926-120	350-926-140
biegsam - scharf, malleable - sharp	350-631-009	350-631-011	350-631-012	350-631-014
biegsam - stumpf, malleable - blunt	350-927-090	350-927-110	350-927-120	350-927-140

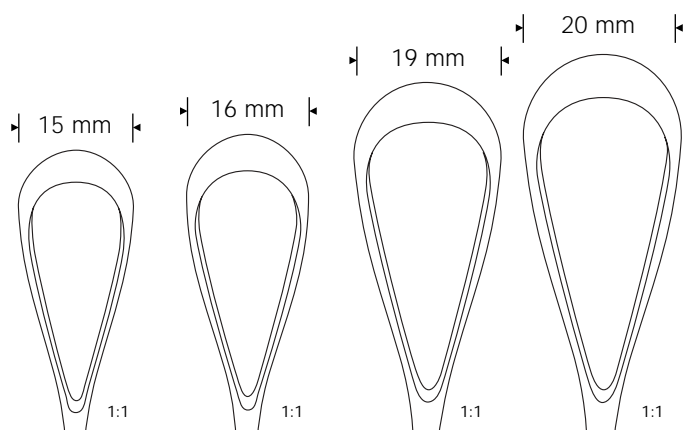

	Fig. 7	Fig. 8	Fig. 9	Fig. 10
fest - scharf, rigid - sharp	350-630-015	350-630-016	350-630-019	350-630-020
fest - stumpf, rigid - blunt	350-926-150	350-926-160	350-926-190	350-926-200
biegsam - scharf, malleable - sharp	350-631-015	350-631-016	350-631-019	350-631-020
biegsam - stumpf, malleable - blunt	350-927-150	350-927-160	350-927-190	350-927-200



Recamier  
31.0 cm, 12 1/4"

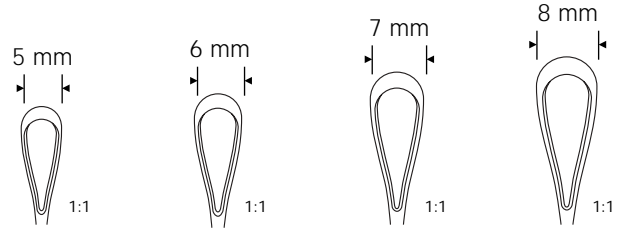

	Fig. 00	Fig. 0	Fig. 1	Fig. 2
fest - scharf, rigid - sharp	350-620-005	350-620-006	350-620-007	350-620-008
fest - stumpf, rigid - blunt	350-619-005	350-619-006	350-619-007	350-619-008
biegsam - scharf, malleable - sharp	350-621-005	350-621-006	350-621-007	350-621-008
biegsam - stumpf, malleable - blunt	350-622-005	350-622-006	350-622-007	350-622-008

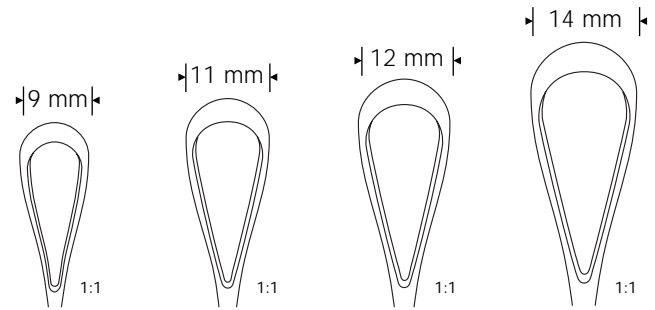

	Fig. 3	Fig. 4	Fig. 5	Fig. 6
fest - scharf, rigid - sharp	350-620-009	350-620-011	350-620-012	350-620-014
fest - stumpf, rigid - blunt	350-619-009	350-619-011	350-619-012	350-619-014
biegsam - scharf, malleable - sharp	350-621-009	350-621-011	350-621-012	350-621-014
biegsam - stumpf, malleable - blunt	350-622-009	350-622-011	350-622-012	350-622-014

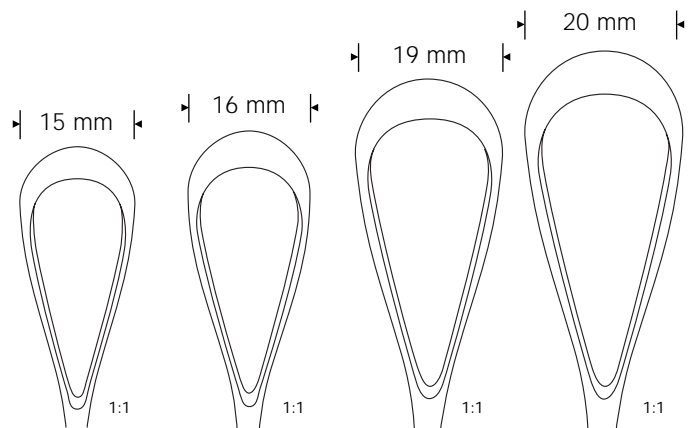
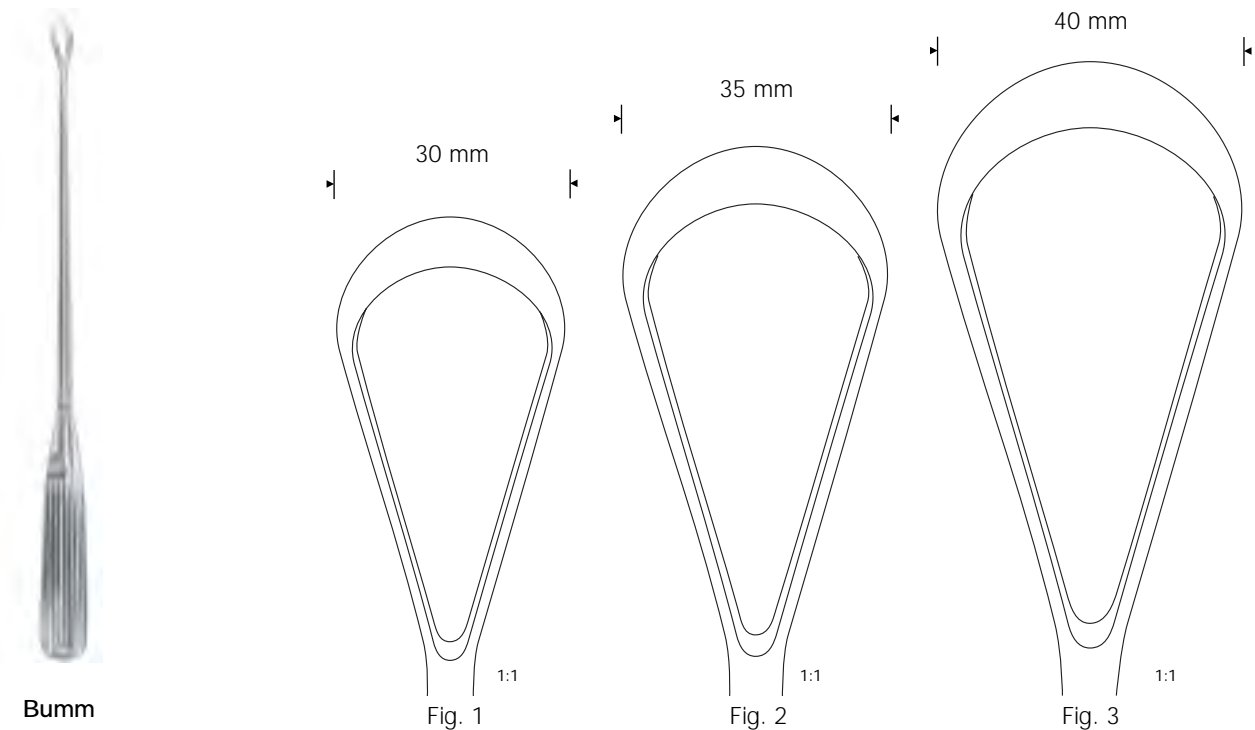

	Fig. 7	Fig. 8	Fig. 9	Fig. 10
fest - scharf, rigid - sharp	350-620-015	350-620-016	350-620-019	350-620-020
fest - stumpf, rigid - blunt	350-619-015	350-619-016	350-619-019	350-619-020
biegsam - scharf, malleable - sharp	350-621-015	350-621-016	350-621-019	350-621-020
biegsam - stumpf, malleable - blunt	350-622-015	350-622-016	350-622-019	350-622-020



Bumm

fest - scharf, rigid - sharp	350-920-300	350-920-350	350-920-400
fest - stumpf, rigid - blunt	350-926-300	350-926-350	350-926-400
biegsam - scharf, malleable - sharp	350-928-300	350-928-350	350-928-400
biegsam - stumpf, malleable - blunt	350-929-300	350-929-350	350-929-400



Simon  
 scharf, sharp  
 25.0 cm, 9 3/4"

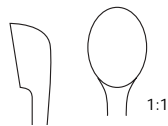

Fig. 1  
 350-610-001

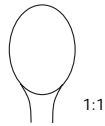

Fig. 2  
 350-610-002

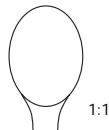

Fig. 3  
 350-610-003

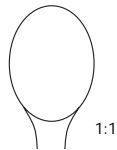

Fig. 4  
 350-610-004

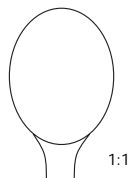

Fig. 5  
 350-610-005

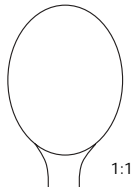
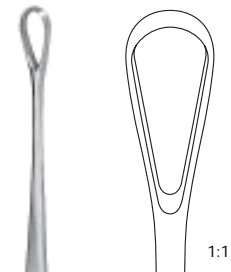
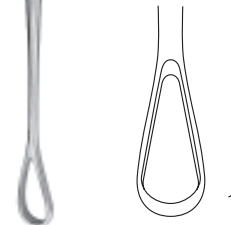

Fig. 6  
 350-610-006



1:1



1:1

Blake  
 scharf / stumpf  
 sharp / blunt  
 27.0 cm, 10 5/8"  
 350-614-270

Die charakteristische S-Form der Van Doren und Thoms-Gaylor Biopsiezangen gewährleistet eine freie Sicht auf das Operationsfeld, wodurch der Operateur eine scharf begrenzte Probeentnahme durchführen kann.

The typical S-shaped design of the Van Doren and Thoms-Gaylor biopsy forceps allows a clear view on the operation field to take a fine, precise probe



**Van Doren**  
26.7 cm, 10 1/2"  
350-855-267



**Thoms-Gaylor**  
gebogen, curved  
22.0 cm, 8 5/8"  
350-857-220  
24.0 cm, 9 1/2"  
350-857-240

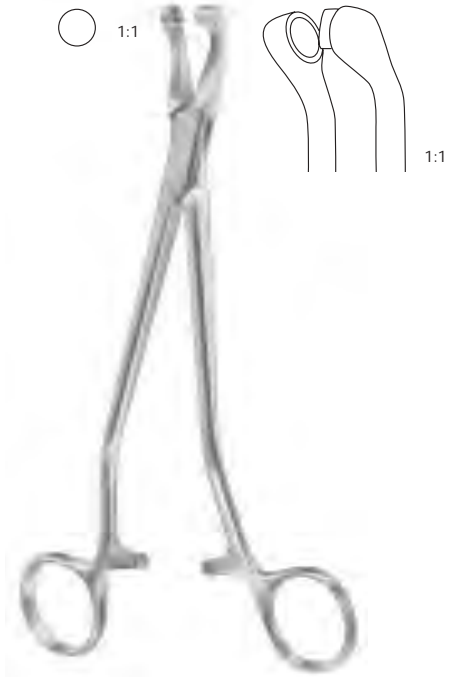

**Thoms-Gaylor**  
24.0 cm, 9 1/2"  
350-849-240



**Faure**  
21.0 cm, 8 1/4"  
350-843-210



**Schubert**  
21.0 cm, 8 1/4"  
350-844-210  
29.0 cm, 11 1/2"  
350-844-290



**Schubert**  
26.0 cm, 10 1/4"  
350-847-260

15



Die folgenden Biopsiezangen sind besonders gut für eine Kolposkopie geeignet, da man mit ihnen auch in tiefere Zonen eindringen kann.

The following Biopsy Forceps are specially suitable for Colposcopy, because with the long shaft you also come to deeper fields.

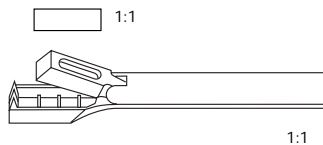
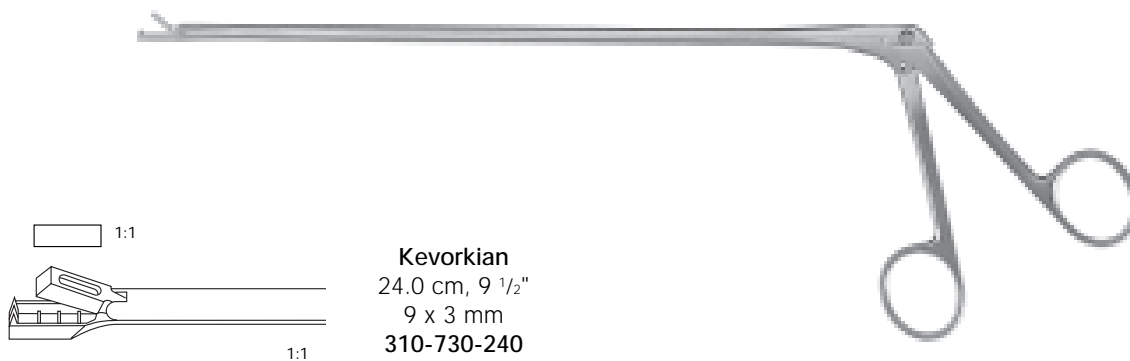

**Kevorkian**  
24.0 cm, 9 1/2"  
9 x 3 mm  
310-730-240

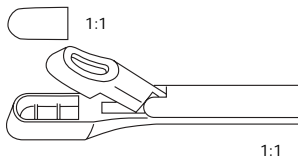

**Eppendorfer**  
20.0 cm, 8"  
4.5 x 8 mm  
310-760-200

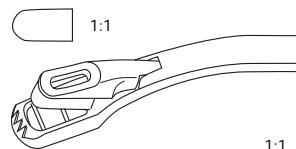

**Wittner**  
20.0 cm, 8"  
4.5 x 8 mm  
gebogen, angled  
310-761-200  
gerade, straight  
310-762-200

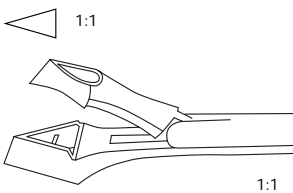

**Schumacher**  
24.0 cm, 9 1/2"  
Fig. 1, 4 mm  
310-729-001

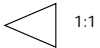
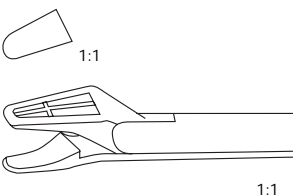

Fig. 2, 6 mm  
310-729-002

Der Vorteil der **Schumacher** Biopsiezangen ist, daß diese durch ihre Nase an der Spitze einen Anhak-Effekt auslösen, und hierdurch das Gewebe sehr gut erfassen können. Des weiteren haben die **Schumacher** Biopsiezangen einen sehr großen Öffnungswinkel, und können so auch an narbigem, flachem Scheidengewölbe angesetzt werden. Ebenfalls haben sie einen glatten ziehenden Schnitt, wodurch sich die Wunde wieder selber schließt und so gut heilen kann.

The advantage of the **Schumacher** Biopsy Forceps is, that the small crook on the upper jaw gives a kind of hoking effect, which grasps the tissue safely. Another advantage is, that angle of opening is also very large, so it can also be used for scarred, flat vaginal vault. Further they also have a smooth steady cut, to get a self-sealing wound which heals well.



**Alexander**  
28.0 cm, 11"  
310-735-280

Der Vorteil der **Alexander** Biopsiezange ist, daß man bedingt durch die Linksbiegung des Maulteiles eine gute Sicht auf das Operations-feld hat. Des weiteren liegt die Schnittkante direkt im Gewebe, welches zur Folge hat, daß man einen exakten und sauberen Schnitt durchführen kann. Sie hat ebenfalls einen ziehenden Schnitt, wodurch eine gute Heilung der Wunde gewährleistet wird.

The advantage of the **Alexander** Biopsy Forceps is, that the left curvage of the jaw allows a good view on the operating field. Further the cutting edge is planted into the tissue, which helps to make an exact and precise bite. It also has a smooth steady cut, so the wound will heal well.



Vorteile der RZ-Biopsie Stanzen  
Advantages of the RZ-biopsy punches

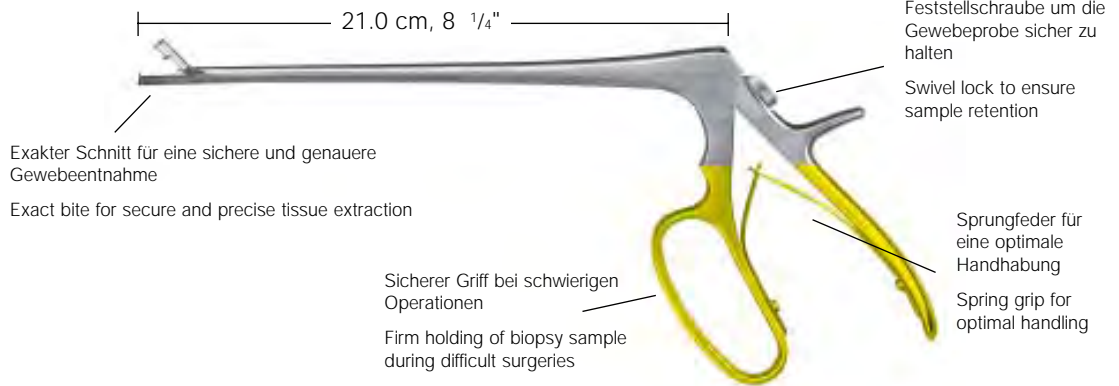

1:1



**Tischler-Morgan**  
7 x 3 mm  
310-733-001

Die klassische Biopsie-Stanze, die von vielen Gynäkologen gegenüber anderen Stanzen bevorzugt wird. Dieses einzigartige Maul hat einen hervorragenden Schneidemechanismus, der das Gewebe in das Maul hineinzieht und das Herausgleiten verhindert.

The classic biopsy punch, a favorite of many gynecologists. The unique jaw has a superior bite mechanism which draws tissue into the jaw and prevents it from slipping out.

1:1



**Mini-Townsend**  
2.3 x 4 mm  
310-733-002

Diese Biopsie-Stanzen sind besonders geeignet bei Patientinnen mit einem engen, externen Muttermund, wenn eine kleine Schädigung im Scheidenkanal sichtbar ist. Die Stanzen bieten die Möglichkeit extrem kleine Gewebeproben zu entnehmen.

1:1



**Baby-Tischler**  
2.3 x 4 mm  
310-733-003

This biopsy punches are particular valuable in patients with a tight, external os, where a small lesion is just seen inside the vaginal canal. The punches offer the opportunity to obtain very small biopsy samples.

1:1



**Tischler-Kevorkian**  
9 x 3 mm  
310-731-200

Diese Biopsie-Stanze vereinigt die Möglichkeit einer Gewebeprobe mit einer rechteckigen Schnittkonfiguration und dem Vorteil eines Tischler Handgriffs, der eine optimale Handhabung gewährleistet.

The biopsy punch combines the opportunity of taking a square configuration tissue sample and the advantage of a Tischler handle which secures an optimal handling.

1:1



**Kevorkian-Pacific**  
9 x 3 mm  
310-732-200

Der Schnitt dieser Stanze ist jedem Gynäkologen bekannt, da er geringe Gewebeverletzungen verursacht. Dies ist die alternative im asiatischen Raum zur gewöhnlichen Kevorkian Biopsie Stanze mit Ringgriff.

The bite of this punch is familiar to all gynecologists because of the little tissue lesion in particular in asian countries. This design is an alternative to the common Kevorkian biopsy punch with the ring handle design.

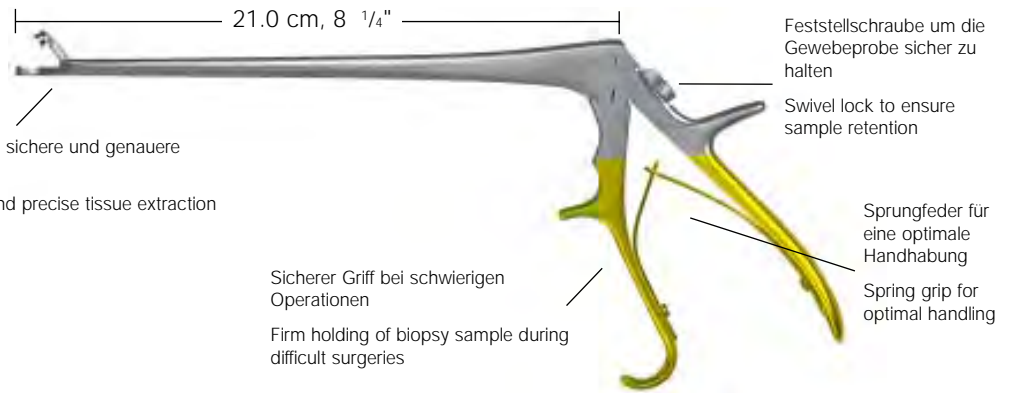

1:1



**Burke**  
5 x 3 mm  
310-732-000

Dieses Modell gewährleistet einen schmalen, präzisen Schnitt mit scharfen Zähnen  
This punch provides a small, precise bite with sharp teeth





**Wrigley**  
28.0 cm, 11"  
340-011-280



**Simpson**  
30.0 cm, 11 3/4"  
340-013-300



**Simpson-Braun**  
33.0 cm, 13"  
340-012-330  
36.0 cm, 14 1/8"  
340-012-360



**Simpson-Luikart**  
36.0 cm, 14 1/8"  
340-029-360



**DeLee**  
30.0 cm, 11 3/4"  
340-018-300



**DeLee**  
36.0 cm, 14 1/8"  
340-018-360

39.0 cm, 15 3/8"  
340-018-390



**Mc Lean**  
36.0 cm, 14 1/8"  
340-020-360



**Kielland**  
41.0 cm, 16"  
340-014-410



**Kielland-Luikart**  
40.0 cm, 15 3/4"  
340-016-400



**Piper**  
44.0 cm, 17 1/4"  
340-017-440



**Elliot**  
32.0 cm, 12 1/2"  
340-025-320  
38.0 cm, 15"  
340-025-380



**Naegele**  
36.0 cm, 14 1/8"  
340-015-360  
40.0 cm, 15 3/4"  
340-015-400

Die Green Armytage Klemmzange wird zur Blutstillung an den Schnitträndern im unteren Segment bei Kaiserschnitt-Entbindungen verwendet.

The Green-Armytage caesarean section hemostatic forceps is used for staunch bleeding edges of the transverse incision in the lower segment.

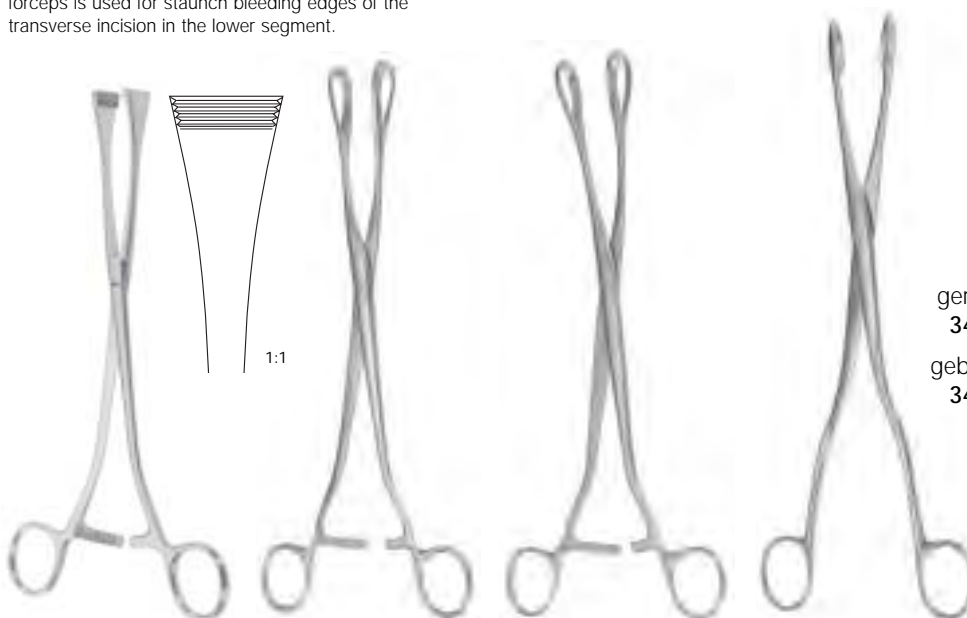

**Green-Armytage**  
21.0 cm, 8 1/4"  
340-150-210

**Saenger**  
27.0 cm, 10 5/8"  
gerade, straight  
340-798-270

**Saenger**  
27.0 cm, 10 5/8"  
gebogen, curved  
340-799-270

**Winter**  
28.0 cm, 11"

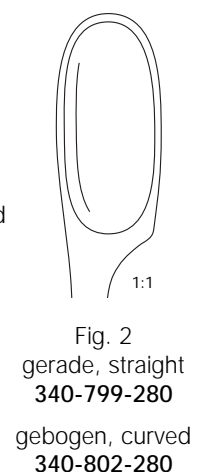
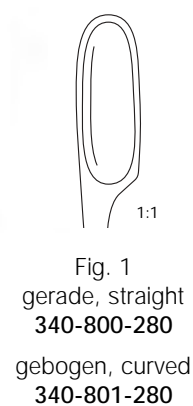

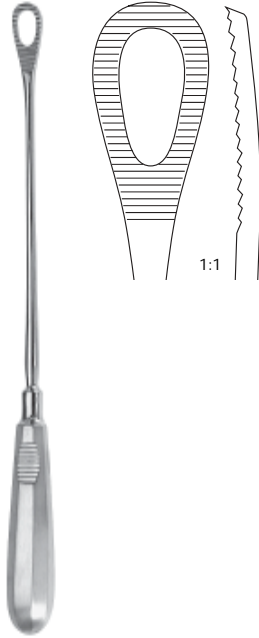

**Pestalozza**  
30.0 cm, 11 3/4"  
340-500-300

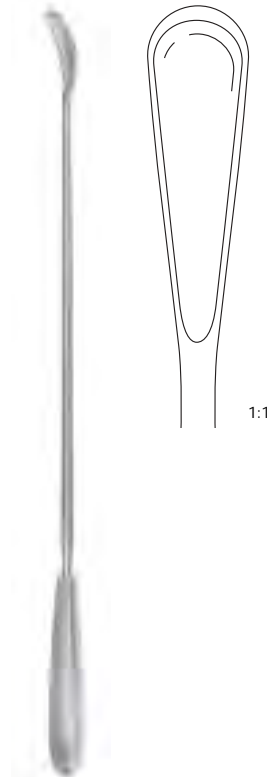

**Wallich**  
stumpf, blunt  
42.0 cm, 16 1/2"  
340-510-420



**Bierer**  
Ovarienfaßzange, Ovum forceps  
33.0 cm, 13"

Maul jaws	ohne Sperre without ratchet	mit Sperre with ratchet
16 mm	350-496-330	350-497-330
19 mm	350-498-330	350-499-330

Beckenzirkel  
Pelvimeter



cm / Zoll-Skala  
cm / inch-scale  
34.0 cm, 13 3/8"  
340-103-340

Circumcisionsgerät  
Circumcision instrument



**Gomco**

Ø	
8 mm	340-600-008
11 mm	340-600-011
13 mm	340-600-013
16 mm	340-600-016
21 mm	340-600-021
26 mm	340-600-026
32 mm	340-600-032

Zusammen mit zwei Arterien- oder Präparierklemmen wird die Vorhaut über die glockenförmige Schutzkappe gezogen, so daß die Eichel geschützt ist. Nun wird die Flügelschraube so stark angezogen, daß die Vorhaut gequetscht wird. Mit einem Skalpell wird die Vorhaut über der Schutzglocke abgeschnitten. Das Circumcisionsgerät bleibt noch einige Zeit angezogen um eine Blutung zu verhindern. Im Falle, daß doch Blutungen auftreten und eine große Ader, speziell die Eichenbändchen-Arterie, verletzt worden sein sollte, muß eine Naht durchgeführt werden. Hierfür eignet sich hervorragend unser Mini-Assistent, Artikel-Nummer 180-959-000 auf Seite 193. Ein Vorteil bei dieser Methode ist der Kosmetische Aspekt, da nur eine minimale Narbe nach dem Entfernen des kleinen Hautstückes übrig bleibt.

Together with two Hemostats or Ligature Forceps the foreskin is pushed over the bellshaped protection-rod and the glans is placed safely into it. By now, the nut is tightened as close as possible, so the foreskin is annularly compressed. The foreskin is cut off with a scalpel, right next to the compression ring. The compression ring should remain a few minutes to avoid bleeding. In case that any large vein, specially the frenular artery, is cut through, a ligature must be set. The advantage of the method described is the cosmetically favourable scar which is left after rejection of the small necrotized portion.



**Unna**  
 14.0 cm, 5 3/4"  
 230-230-140



**Unna**  
 14.0 cm, 5 3/4"  
 230-232-140



**Saalfeld**  
 10.0 cm, 4"  
 230-239-100

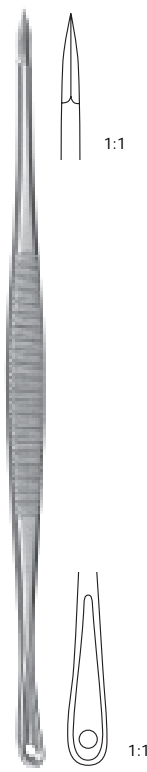

**Saalfeld**  
 14.0 cm, 5 3/4"  
 230-236-140

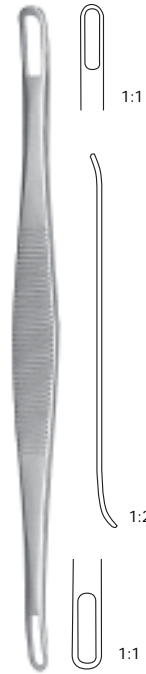

**Schamberg**  
 10.0 cm, 4"  
 230-238-100



**Walton**  
 14.0 cm, 5 3/4"  
 230-240-140



**Fox**  
 14.0 cm, 5 3/4"



3 mm  
 230-151-140



4 mm  
 230-152-140



5 mm  
 230-153-140



6 mm  
 230-154-140



**Piffard**  
 14.0 cm, 5 3/4"



Fig. 1  
 230-155-001



Fig. 2  
 230-155-002



Fig. 3  
 230-155-003

2 mm  
 230-160-002



12.0 cm, 4 3/4"

3 mm  
 230-160-003

4 mm  
 230-160-004

5 mm  
 230-160-005

6 mm  
 230-160-006

7 mm  
 230-160-007

8 mm  
 230-160-008



**Keys**  
 komplett, complete  
 230-160-000

**Keys**

17



Sägeblatt  
Saw Blade  
210-972-000

**Walton**  
Fingerringsäge  
Finger ring saw  
210-972-160



Sägeblatt  
Saw Blade  
210-976-000

Fingerringsäge  
Finger ring saw  
210-975-170

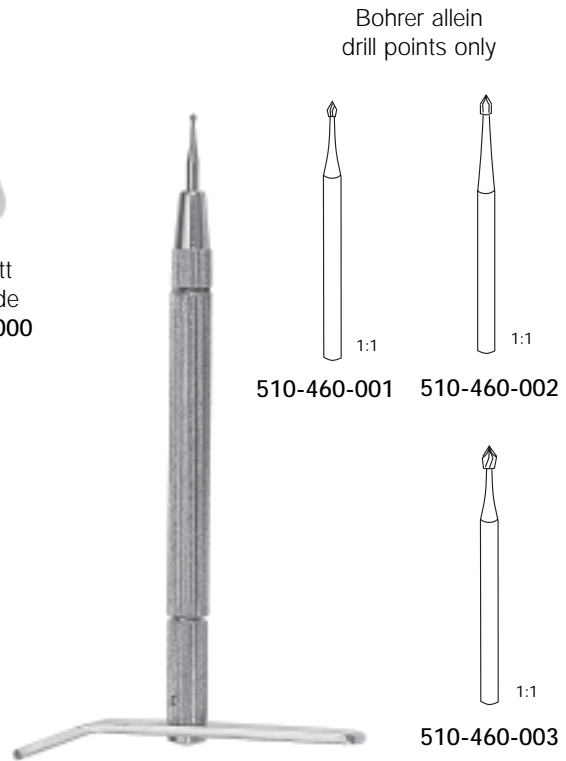

Nagelbohrer mit 3 Bohrern  
Finger nail drill with 3 drill points  
510-460-000



**Radolf**  
Nagelausreißzange  
Nail extracting forceps  
13.5 cm, 5 3/8"  
510-462-130



Nagelspaltzange  
Nail splitting forceps  
13.5 cm, 5 3/8"  
510-334-140



Nagelzange  
Nail nipper  
13.0 cm, 5"  
510-347-130



Nagelzange  
Nail nipper  
14.0 cm, 5 1/2"



20.0 cm, 8"  
600-080-200



Cheatle  
27.0 cm, 10 <sup>5</sup>/<sub>8</sub>"  
600-095-270



Rogge  
23.0 cm, 9"  
600-087-230



Pye-Smith (Harrison)  
35.0 cm, 13 <sup>3</sup>/<sub>4</sub>"  
600-088-350



Mayo  
14.0 cm, 5 <sup>1</sup>/<sub>2</sub>"  
660-100-140



Bunt  
12.0 cm, 4 <sup>3</sup>/<sub>4</sub>"  
660-102-120



Standgefäß ohne Deckel  
jar without lid

75 mm ø x 130 mm	660-142-006
75 mm ø x 175 mm	660-142-007
100 mm ø x 175 mm	660-142-008
100 mm ø x 200 mm	660-142-009



runde Schale, round bowl

40 mm ø	600-231-040
60 mm ø	600-231-060
80 mm ø	600-231-080
100 mm ø	600-231-100
120 mm ø	600-231-120
150 mm ø	600-231-150



Nierenschale, kidney tray

170 mm	600-673-170
250 mm	600-673-250 (Standard)
275 mm	600-673-275



runde Schale, round bowl

165 x 55 mm	0.75 l	600-170-165
175 x 70 mm	1.00 l	600-170-175
225 x 100 mm	2.00 l	600-170-225
240 x 95 mm	2.75 l	600-170-240
260 x 120 mm	4.00 l	600-170-260
315 x 150 mm	5.50 l	600-170-315
325 x 135 mm	8.00 l	600-170-325
360 x 165 mm	12.00 l	600-170-360
415 x 150 mm	14.00 l	600-170-415
290 x 100 mm	5.00 l	600-170-290



Instrumentenkasten, instrument box

200 x 150 x 25 mm	600-310-200
260 x 180 x 30 mm	600-310-260
300 x 220 x 30 mm	600-310-300
350 x 220 x 40 mm	600-310-350
220 x 170 x 50 mm	600-312-220
280 x 200 x 50 mm	600-312-280
320 x 240 x 50 mm	600-312-320
370 x 270 x 50 mm	600-312-370
420 x 320 x 50 mm	600-312-420

Aus Drahtgeflecht  
wire mesh

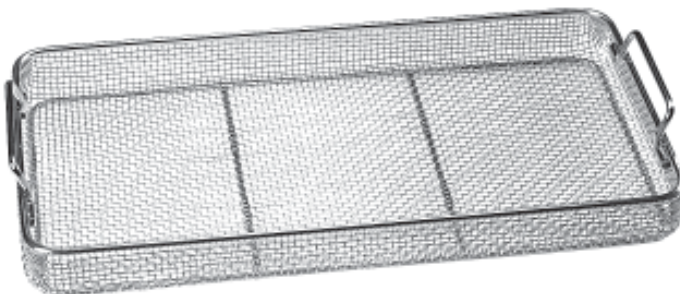

Sterilisierkorb, Sterilizing tray

240 x 250 x 50 mm	600-281-240
480 x 250 x 50 mm	600-281-480
550 x 250 x 50 mm	600-281-550



Nadelsterilisierdose  
Needle sterilizing case  
ø 65 x 17 mm  
600-100-065

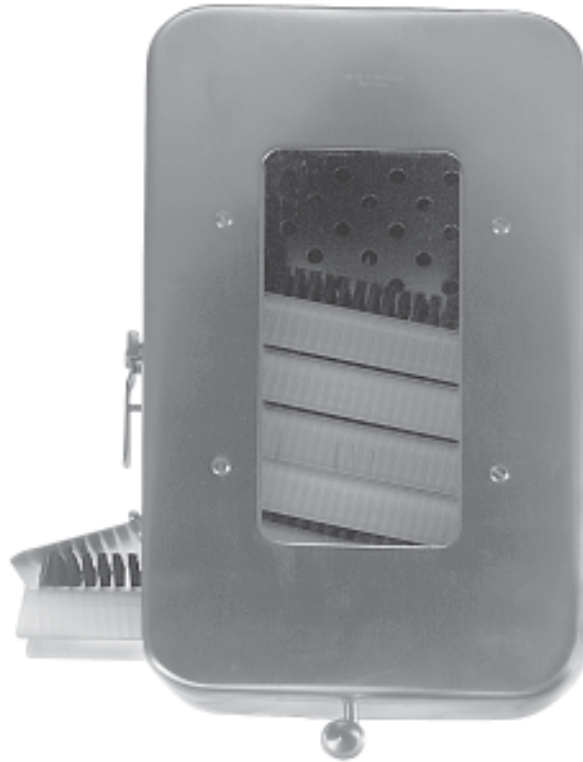

**RZ-Bürstenspender**  
**RZ-Brush dispenser**  
für 10 Bürsten (ohne Bürsten),  
mit Aufhängevorrichtung  
for 10 brushes (without brushes),  
with suspension hook  
**600-950-100**

**RZ-Bürstenspender**  
**RZ-Brush dispenser**  
für 20 Bürsten (ohne Bürsten),  
mit Aufhängevorrichtung  
for 20 brushes (without brushes),  
with suspension hook  
**600-951-100**

Aufhängevorrichtung für kleinen  
RZ-Bürstenspender  
Suspension hook for small  
RZ-Brush dispenser  
**600-950-101**  
für große RZ-Bürstenspender  
for large RZ-Brush dispenser  
**600-951-101**

mehr als 400 x autoklavierbar  
more than 400 x autoclavable



Handwaschbürste, (1 Packung beinhaltet 10 Bürsten)  
handbrush, (1 box containing 10 brushes)  
**600-050-000**





Die RZ-Medizintechnik Farbbänder stellen eine schnelle und kostengünstige Möglichkeit dar, um chirurgische Instrumente zu markieren. RZ-Farbbänder machen es Ihnen einfach, Ihr eigenes Markierungssystem zu entwickeln, um Instrumente nach ihrer Art, Anwendung oder nach Eigentümer zu kennzeichnen.

Die haltbaren Rollen sind in zehn auffälligen Farben lieferbar. Sie sind sehr leicht anzubringen. Sie wurden klinisch getestet und wurden als sicher bei normaler Flash und Gas-Sterilisation anerkannt.

RZ-Farbbänder sind 6.5 mm, 1/4" breit und werden in 7.6 m, 300" Länge auf Spulen geliefert. Dies reicht aus, um ungefähr 250 Instrumente zu markieren. Jede Spule wird in einer harten Plastikbox geliefert und kann dadurch leicht gelagert werden.

#### Anwendung:

Das Instrument sowie die Hände müssen trocken und frei von jeglichen Mitteln sein. RZ-Medizintechnik Farbbänder müssen abgeschnitten und nicht abgerissen werden. Es muß genug abgeschnitten werden, so daß sich das Band mindestens einmal selber überklebt.

RZ-Farbbänder dürfen nicht gedehnt werden.

Nachdem das Farbband aufgetragen wurde, muß das Instrument sterilisiert werden. Dadurch haftet das Band nun am Instrument und hat sich mit diesem fest verbunden.

Nach dem Gebrauch die Rolle wieder in die Plastikbox legen.

Die Bänder sollten alle 6-8 Monate gewechselt werden.

Bei Scheren muß das Band an den Ringen angebracht werden, so daß die Funktion nicht beeinträchtigt wird.

Um das Band vom Instrument zu entfernen, nimmt man ein Skalpell zur Hilfe und reinigt es anschließend mit einer gewöhnlichen Reinigungsmilch.

RZ-Medizintechnik presents an inexpensive way of color coding surgical instruments. RZ-Color Coding Tapes make it easy to create your own labeling system for identifying and sorting instruments by type, specialty and ownership.

The durable tapes come in ten highvisible colors. They are easy to apply. They have been clinically tested and found safe for use in conventional flash or gas sterilization units.

RZ-Color Coding Tapes are 6.5 mm, 1/4" wide and packaged of spools in 7.6 m, 300" length. That's enough to code approximately 250 instruments. Each spool comes in it's own hard-plastic box for easy storage.

#### Instructions:

The instrument and the hands must be dry and free from any residue.

RZ-Color Coding Tapes must be cut not torn.

Enough tape must be cut to overlap itself at least once.

The tape must not be stretched.

Upon completing the application of RZ-Color Coding Tapes, autoclave the instruments. The tape will bond itself to the instruments. Replace the roll in its plastic box after use.

Do not put the tape on the shanks of scissors, as this interferes with the function of the instrument. Place the tape on the finger rings of the scissors.

Change RZ-Color Coding Tapes at least every 6-8 months.

To remove the tape, cut with a razor blade and clean with any instrument cleaner.

Grün, green	900-950-001
Gelb, yellow	900-950-002
Blau, blue	900-950-003
Rot, red	900-950-004
Braun, brown	900-950-005
Weiß, white	900-950-006
Orange, orange	900-950-007
Schwarz, black	900-950-008
Lila, purple	900-950-009
Hellorange, bright orange	900-950-010



### Metric Conversion

To Convert	to	Multiply by
millimeter (mm)	centimeter (cm)	0.1
millimeter (mm)	meter (m)	0.001
centimeter (cm)	meter (m)	0.01
cubic centimeter (cc)	milliliter (ml)	1
cubic centimeter (cc)	liter (l)	0.001
gramm (g)	miligramm (mg)	1 000
gramm (g)	kilogramm (kg)	0.001
<hr/>		
centimeter (cm)	millimeter (mm)	10
meter (m)	millimeter (mm)	1 000
meter (m)	centimeter (cm)	100
milliliter (ml)	cubic centimeter (cc)	1
liter (l)	cubic centimeter (cc)	1 000
miligramm (mg)	gramm (g)	0.001
kilogramm (kg)	gramm (g)	1.000

### English Conversion

To Convert	to	Multiply by
inch	millimeter (mm)	25.4
inch	centimeter (cm)	2.54
quart	liter (l)	0.946
ounce (fluid)	liter (l)	0.0296
ounce (fluid)	cubic centimeter (cc)	29.6
ounce (fluid)	milliliter (ml)	29.6
pound (dry)	kilogramm (kg)	0.454
ounce (dry)	gramm (g)	28.3
<hr/>		
millimeter (mm)	inch	0.0394
centimeter (cm)	inch	0.394
liter (l)	quart	1.06
liter (l)	ounce (fluid)	33.8
cubic centimeter (cc)	ounce (fluid)	0.0338
milliliter (ml)	ounce (fluid)	0.0338
kilogramm (kg)	pound (dry)	2.20
gramm (g)	ounce (dry)	0.035

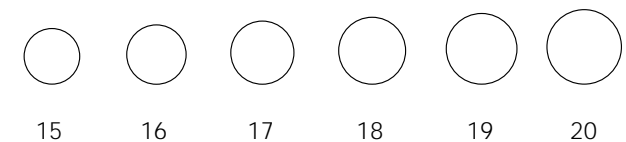
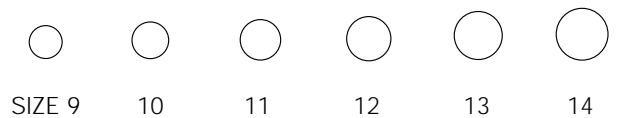
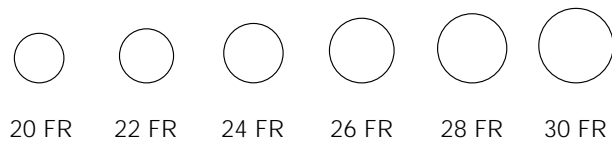
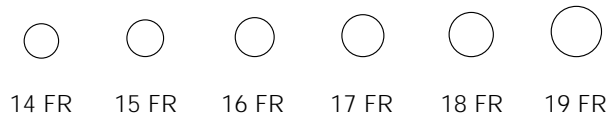

### French Scale

6 French	2.0 mm	16 French	5.3 mm
7 French	2.3 mm	17 French	5.7 mm
8 French	2.7 mm	18 French	6.0 mm
9 French	3.0 mm	19 French	6.3 mm
10 French	3.3 mm	20 French	6.7 mm
11 French	3.7 mm	22 French	7.3 mm
12 French	4.0 mm	24 French	8.0 mm
13 French	4.3 mm	26 French	8.7 mm
14 French	4.7 mm	28 French	9.3 mm
15 French	5.0 mm	30 French	10.0 mm

### American Scale

Size 9	4.5 mm	Size 15	7.5 mm
Size 10	5.0 mm	Size 16	8.0 mm
Size 11	5.5 mm	Size 17	8.5 mm
Size 12	6.0 mm	Size 18	9.0 mm
Size 13	6.5 mm	Size 19	9.5 mm
Size 14	7.0 mm	Size 20	10.0 mm

