

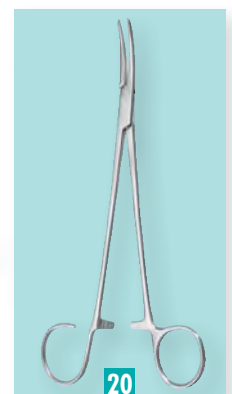

CHAPTER	PAGE
INSTRUMENT SETS	4-14
SCISSORS	15-58
FORCEPS	59-68
MONOPOLAR FORCEPS	69-72
BIPOLAR NON-STICK FORCEPS	73-76
FORCEPS & CLAMPS	77-80
NEEDLE HOLDERS	81-90
WOUND RETRACTORS	91-102
NASAL RASPS	103-110
CHISELS & OSTEOTOMES	111-120
RHINOPLASTIC SET	121-124
MALLETS	125-126
NASAL SPECULA	127-144
NASAL INSTRUMENTS	145-154
DERMATOLOGY INSTRUMENTS	155-168
CLEFT PALATE INSTRUMENTS	169-172
SHAPERS	173-182
ENDOSCOPIC INSTRUMENTS	183-188
RETRACTORS & DISSECTORS	189-214
MARKERS & CALIPERS	215-220
SUCTION INSTRUMENTS	221-238
DEVICES & ACCESSORIES	239-249
INDEX	250-268

260-990-001 ABDOMINOPERINEAL RESECTION SET

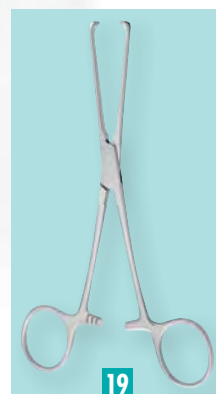
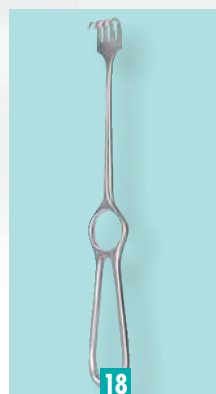
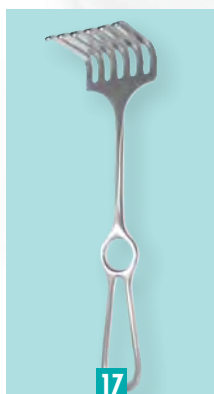
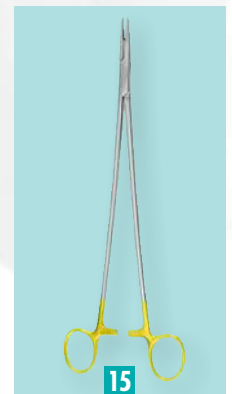
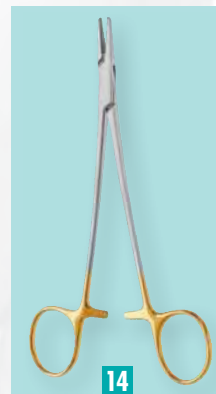
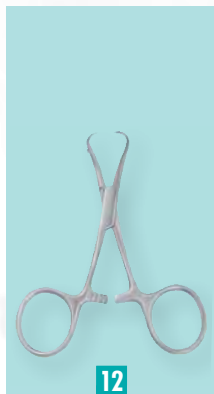
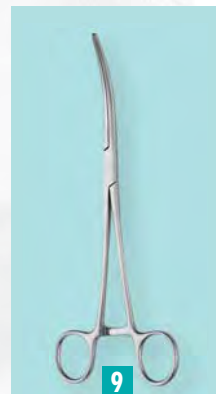
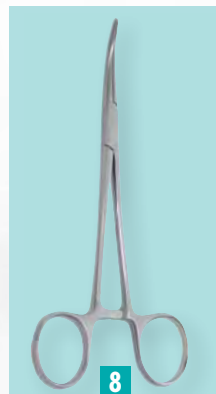
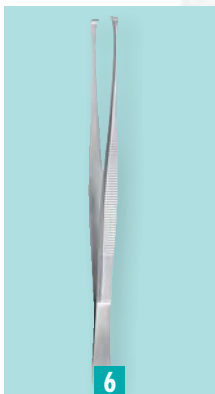
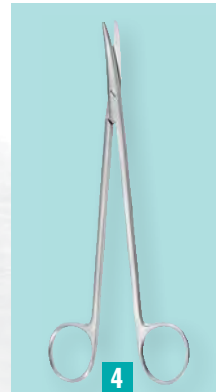
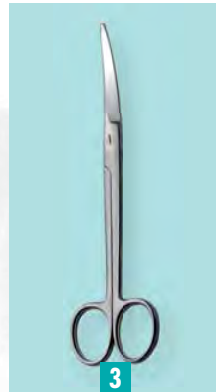

260-990-001 ABDOMINOPERINEAL RESECTION SET

Picture	Order number	Quantity	Description
1	120-030-170	2 x	Mayo Operating Scissors, straight, 170mm, 6 ² / ₃ "
2	120-031-170	2 x	Mayo Operating Scissors, curved, 170mm, 6 ² / ₃ "
3	120-031-230	2 x	Mayo Operating Scissors, curved, 230mm, 9"
4	120-111-180	2 x	Metzenbaum-Nelson Scissors, Fig. 1, curved, blunt/blunt, 180mm, 7"
5	130-510-250	1 x	Russian Tissue Forceps, 250mm, 10"
6	130-562-230	2 x	Nelson Tissue Forceps, Lung Dissecting Forceps, 230mm, 9"
7	140-291-140	10 x	Crile Hemostatic Forceps, curved, serrated, 140mm, 5 ¹ / ₂ "
8	140-295-160	6 x	Crile-Rankin Hemostatic Forceps, curved, 160mm, 6 ¹ / ₄ "
9	140-331-200	2 x	Rochester-Pean Hemostatic Forceps, curved, 200mm, 8"
10	140-332-200	6 x	Kocher-Ochsner Hemostatic Forceps, straight, 1x2 teeth, 200mm, 8"
11	140-361-280	3 x	Gemini Dissecting Forceps, 280mm, 11"
12	140-573-130	6 x	Backhaus Towel Forceps, 130mm, 5 ¹ / ₈ "
13	150-052-250	2 x	Foerster Swab Forceps, straight, serrated, 250mm, 10"
14	180-540-180	2 x	Crile-Wood TC Needle Holder, straight, serrated, 180mm, 7"
15	180-562-270	1 x	Wangensteen TC Needle Holder, 270mm, 10 ² / ₃ "
16	170-220-004	1 x	Israel Retractor, 40 x 40mm, 4 prongs, blunt, 250mm, 10"
17	170-220-006	1 x	Israel Retractor, 50 x 60 mm, 6 prongs, blunt, 250mm, 10"
18	170-227-215	2 x	Volkman Retractor, blunt, 4 prongs, 9 x 19mm, 215mm, 8 ¹ / ₂ "
19	310-014-150	12 x	Allis Tissue Forceps, 5 x 6 teeth, 150mm, 6"
20	140-630-190	8 x	Schmidt Tonsil Seizing Forceps, slightly curved, with one open ring, 185mm, 7 ¹ / ₄ "

260-990-002 BREAST SURGERY SET

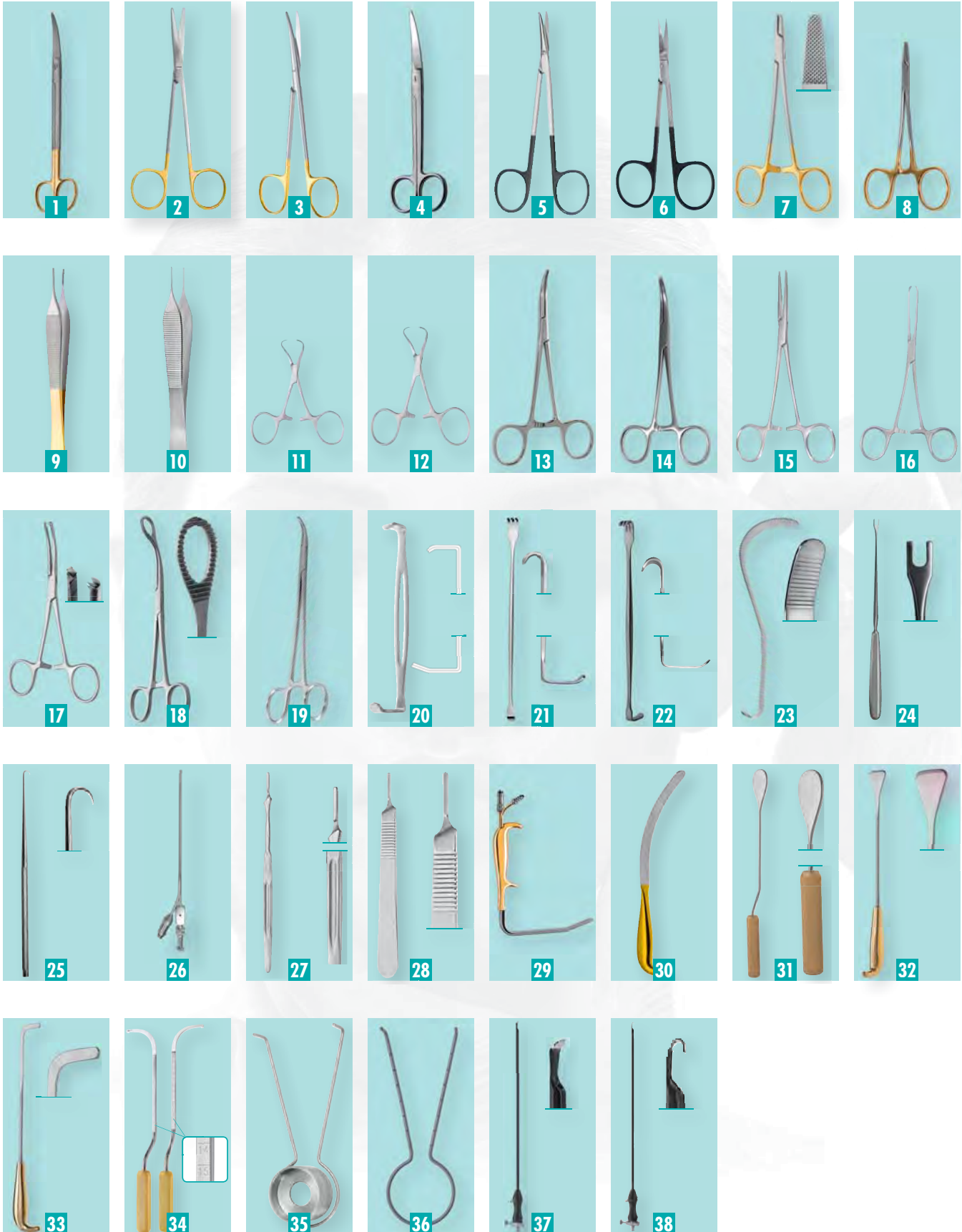



260-990-002 BREAST SURGERY SET

Picture	Order number	Quantity	Description
1	120-507-225	1 x	Bostwick-Mayo TC Scissors, curved, serrated, blunt bevelled tip, 225mm, 9"
2	120-510-145	1 x	Metzenbaum TC Scissors, Fig. 1, straight, blunt/blunt, 145mm, 5 ^{3/4} "
3	120-511-145	1 x	Metzenbaum TC Scissors, Fig. 1, curved, blunt/blunt, 145mm, 5 ^{3/4} "
4	120-031-170	1 x	Mayo Operating Scissors, curved, 170mm, 6 ^{2/3} "
5	121-095-115	1 x	Strabismus Super-Cut Scissors, curved, 115mm, 4 ^{1/2} "
6	121-075-105	1 x	Iris Super-Cut Scissors, curved, sharp/sharp, 105mm, 4 ^{1/8} "
7	180-550-160	2 x	Mayo Hegar TC Needle Holder, straight, serrated, 160mm, 6 ^{1/4} "
8	180-530-120	2 x	Webster TC Needle Holder, smooth, 115mm, 4 ^{1/2} "
9	130-529-120	2 x	Adson-Brown TC Forceps, 7x7 teeth, 2mm tooth line, tying platform, 120mm, 4 ^{3/4} "
10	130-140-120	1 x	Adson Tissue Forceps, 1x2 teeth, 120mm, 4 ^{3/4} "
11	140-573-090	2 x	Backhaus Towel Forceps, 90mm, 3 ^{1/2} "
12	140-573-110	2 x	Backhaus Towel Forceps, 110mm, 4 ^{1/2} "
13	140-255-125	6 x	Halsted-Mosquito Hemostatic Forceps, curved, 125mm, 5"
14	140-293-140	4 x	Crile Hemostatic Forceps, 1x2 teeth, curved, 140mm, 5 ^{1/2} "
15	140-281-140	2 x	Kelly Hemostatic Forceps, curved, 140mm, 5 ^{1/2} "
16	310-012-150	4 x	Allis Tissue Forceps, 4x5 teeth, 150mm, 6"
17	140-333-140	2 x	Kocher-Ochsner Hemostatic Forceps, 1x2 teeth, curved, 140mm, 5 ^{1/2} "
18	150-055-250	3 x	Foerster Swab Forceps, curved, serrated, 250mm, 10"
19	140-311-185	1 x	Adson Hemostatic Forceps, curved, 185mm, 7 ^{1/4} "
20	170-687-210	1 x	US Army Parker-Langenbeck Retractor set, Fig. 1 and Fig. 2, double pair, 210mm, 8 ^{1/4} "
21	170-215-160	1 x	Senn Retractor, sharp, 6 x 13mm, 160mm, 6 ^{1/4} "
22	170-216-160	1 x	Senn Retractor, blunt, 6 x 13mm, 160mm, 6 ^{1/4} "
23	171-591-330	1 x	Deaver Retractor, serrated, 5mm wide, 330mm, 13"
24	420-190-160	2 x	Joseph Rhinoplastic Hook, 2 hooks, 160mm, 6 ^{1/4} "
25	420-183-150	2 x	Joseph Rhinoplastic Hook, 1 Hook, 150mm, 6"
26	165-522-130	1 x	Frazier Suction Tube, straight, with fibre-optic, 10 Fr., WL 130mm, 5 ^{1/8} "
27	110-130-077	1 x	Scalpel Handle No. 7, 165mm, 6 ^{1/2} "
28	110-110-003	2 x	Scalpel Handle No. 3, 130mm, 5 ^{1/8} "
29	260-150-125	1 x	Breast Retractor, with fibre-optic and suction, 150x25mm, 180mm, 7"
30	260-400-315	1 x	Breast Spatula, semi-malleable, serrated, 150x25mm, 315mm, 12 ^{1/3} "
31	260-016-410	1 x	MacCollum-Dingman Breast Dissector, angled shaft, 410mm, 16"
32	260-011-000	1 x	Sculpo Breast Spatula Dissector, 330mm, 13"
33	260-010-000	1 x	Sculpo Breast Dissector, angled, 330mm, 13"
34	260-088-370	1 x	Agris-Dingman Transaxillary Dissector, set for creation of submammary pockets, with scale, 360mm, 14"
35	260-750-138	1 x	Freeman Areola Marker, Ø 38 mm
35	260-750-142	1 x	Freeman Areola Marker, Ø 42 mm
35	260-750-145	1 x	Freeman Areola Marker, Ø 45 mm
36	260-738-000	1 x	McKissock Breast Caliper, Ø 38 mm
36	260-742-000	1 x	McKissock Breast Caliper, Ø 42 mm
36	260-745-000	1 x	McKissock Breast Caliper, Ø 45 mm
37	260-712-000	1 x	Spatula Electrode, straight, with suction and trumpet valve, 270mm, 10 ^{2/3} "
38	260-710-000	1 x	J-Hook Electrode, straight, with suction and trumpet valve, 270mm, 10 ^{2/3} "



260-990-003 BASIC RHINOPLASTY SET

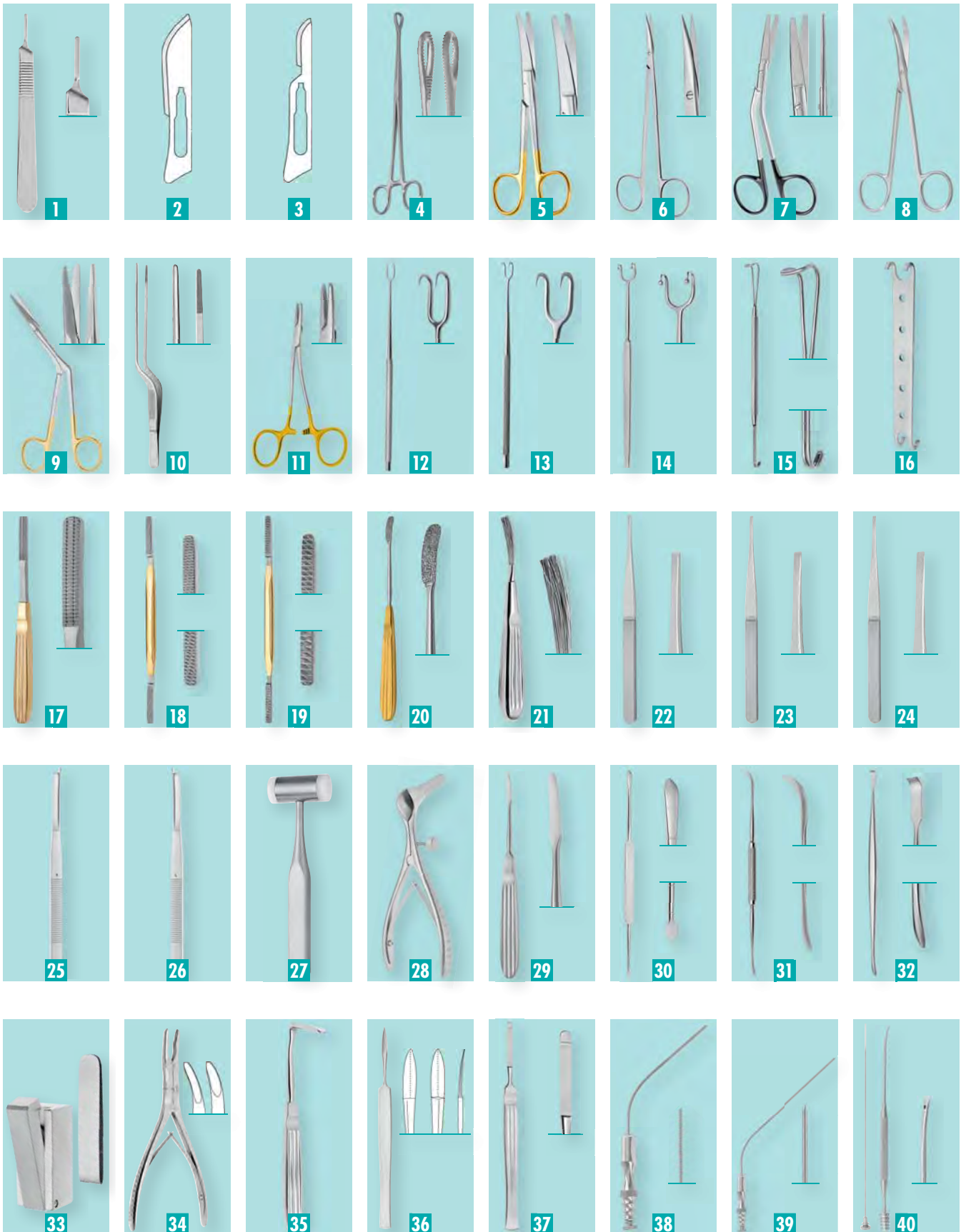

260-990-003 BASIC RHINOPLASTY SET

Picture	Order number	Quantity	Description
1	110-110-003	2 x	Scalpel Handle No. 3, 130mm, 5 ¹ / ₈ "
2	110-201-010	1 x	Scalpel blades Fig. 10, sterile, 100 pieces
3	110-201-015	1 x	Scalpel blades Fig. 15, sterile, 100 pieces
4	150-052-250	4 x	Foerster Swab Forceps, straight, serrated, 250mm, 10"
5	120-507-145	1 x	Mayo TC Operating Scissors, curved, 145mm, 5 ³ / ₄ "
6	120-121-150	1 x	Nerve Dissecting Scissors, curved, sharp, 150mm, 6"
7	121-280-145	1 x	Fomon Super-Cut Dorsal Scissors, straight, 145mm, 5 ³ / ₄ "
8	120-131-135	1 x	Fomon Dissecting Scissors, strongly curved, 135mm, 5 ¹ / ₄ "
9	120-583-180	1 x	Heymann TC Nasal Scissors, one serrated blade, 180mm, 7"
10	410-395-190	1 x	Jansen Nasal Dressing Forceps, bayonet shaped, serrated, 190mm, 7 ¹ / ₂ "
11	180-525-135	2 x	Kilner TC Needle Holder, s-curved, serrated, 135mm, 5"
12	170-014-005	1 x	Joseph Hooklet, 2 prongs, 5mm, 160mm, 6 ¹ / ₄ "
13	170-014-007	1 x	Joseph Hooklet, 2 prongs, 7mm, 160mm, 6 ¹ / ₄ "
14	230-280-160	1 x	Fomon Alar Retractor, 2 prongs, blunt, buttoned, 160mm, 6 ¹ / ₄ "
15	170-036-180	1 x	Neivert Nasal Retractor, 160mm, 6 ¹ / ₄ "
16	260-501-120	1 x	Converse Allar Retractor, double-ended, blunt, 120mm, 4 ³ / ₄ "
17	420-672-000	1 x	Original Maltz TC Nasal Rasp, backward cutting, straight, 180mm, 7"
18	420-660-214	1 x	Fomon TC Rasp, double-ended, Fig. 3/4, fine/coarse, 7 x 40mm, 210mm, 8 ¹ / ₄ "
19	420-660-218	1 x	Fomon TC Rasp, double-ended, Fig. 7/8, coarse/very coarse, 7 x 40mm, 210mm, 8 ¹ / ₄ "
20	420-650-100	1 x	Peet-Cottle Nasal Rasp, curved, diamond jaws, 175mm, 7"
21	260-500-001	1 x	Wire brush, for cleaning of nasal rasps, 165mm, 6 ¹ / ₂ "
22	420-568-002	1 x	RZ Nasal Osteotome, special handle, 2mm wide, 180mm, 7"
23	420-568-004	1 x	RZ Nasal Osteotome, special handle, 4mm wide, 180mm, 7"
24	420-568-006	1 x	RZ Nasal Osteotome, special handle, 6mm wide, 180mm, 7"
25	420-459-002	1 x	Silver Cartilage Chisel, curved right, single guarded, 180mm, 7"
26	420-459-003	1 x	Silver Cartilage Chisel, curved left, single guarded, 180mm, 7"
27	210-264-140	1 x	RZ Mallet, with 2 interchangeable plastic discs, 140g, Ø 25mm, 185mm, 7 ¹ / ₄ "
28	420-138-055	1 x	Killian-Walter Nasal Speculum, aseptic joint, with locking screw, thin blades, 55mm blade length, 140mm, 5 ¹ / ₂ "
29	420-530-165	1 x	Joseph Periosteal Elevator, slightly curved, hollow handle, 2mm wide, 170mm, 6 ³ / ₄ "
30	420-550-230	1 x	Cottle Septum Elevator, double-ended, sharp/blunt, graduated, 210mm, 8 ¹ / ₄ "
31	420-532-200	1 x	Obwegeser-Freer Septum Elevator, sharp/blunt, 200mm, 8"
32	420-552-215	1 x	Howarth Elevator, double-ended, sharp/blunt, 215mm, 8 ¹ / ₄ "
33	420-365-000	1 x	Cottle Cartilage Crusher, 28mm wide, with removal clip forceps, 75mm, 3"
34	210-790-180	1 x	Beyer Bone Rongeur, curved, double action, 4mm, 180mm, 7"
35	420-250-160	1 x	Aufrecht Nasal Retractor, 10 x 45mm blade, 160mm, 6 ¹ / ₄ "
36	420-191-003	1 x	Joseph Nasal Knife, curved, sharp, double-edge, 150mm, 6"
37	420-205-160	1 x	Joseph Nasal Knife, straight, button-end knife, 150mm, 6"
38	165-525-010	1 x	Fergusson Suction Canulla, finger cut-off, stylet, Luer Lock, 10 Fr., Ø 3.3mm, 180mm, 7"
39	165-525-007	1 x	Fergusson Suction Canulla, finger cut-off, stylet, Luer Lock, 7 Fr., Ø 2.3mm, 180mm, 7"
40	420-395-205	1 x	Negus Aspirating Dissector, blunt, Ø 6mm, 205mm, 8"

260-990-004 BLEPHAROPLASTY SET

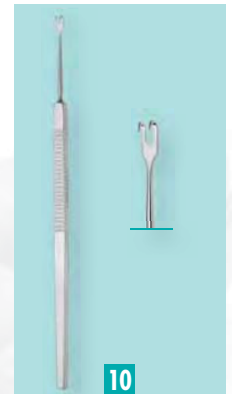
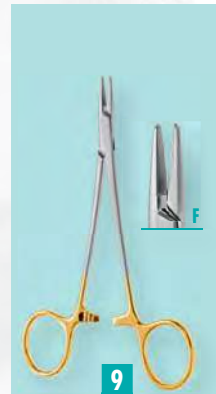
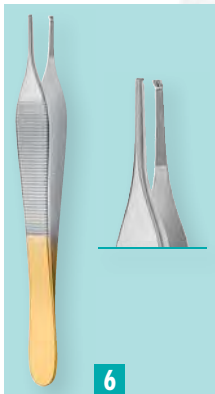
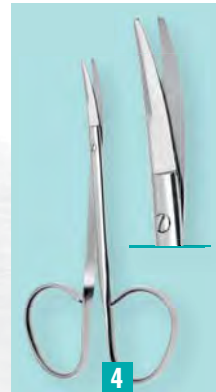
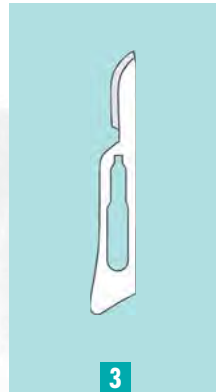
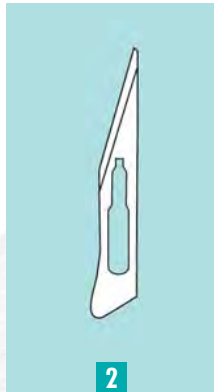

260-990-004 BLEPHAROPLASTY SET

Picture	Order number	Quantity	Description
1	110-110-003	2 x	Scalpel Handle No.3, 130mm, 5 ¹ / ₈ "
2	110-201-011	1 x	Scalpel blades Fig.11, sterile, 100 pieces
3	110-201-015	1 x	Scalpel blades Fig.15, sterile, 100 pieces
4	120-135-115	1 x	Kaye Blepharoplasty Scissors, curved, serrated, Ribbon handle, 115mm, 4 ¹ / ₂ "
5	120-091-095	1 x	Walton Tenotomy Scissors, curved, sharp, Ribbon handle, 100mm, 4"
6	130-534-120	1 x	Adson TC Tissue Forceps, 1x2 teeth, 120mm, 4 ³ / ₄ "
7	400-137-030	1 x	Castroviejo Suturing Forceps, straight, 1x2 teeth, 0.3mm, with tying platform, hole handle, 110mm, 4 ¹ / ₃ "
8	180-536-130	1 x	Halsey TC Needle Holder, smooth, 130mm, 5"
9	180-532-120	1 x	Derf TC Needle Holder, straight, serrated, 120mm, 4 ³ / ₄ "
10	170-042-160	2 x	Guthrie Wound Retractor, Fig. 1, 2 prongs, sharp, 160mm, 6 ¹ / ₄ "
11	170-015-140	2 x	Cushing Fine Wound Retractor, 140mm, 5 ¹ / ₂ "
12	400-602-267	1 x	Container for ophthalmology, with silicon mat, with 2 layers, 267 x 159 x 35mm
13	400-850-255	1 x	Cox Ocular Shield incl. Suction Cup, medium, 25.5x22mm
14	170-512-160	1 x	Desmarres Retractor, insulated, 12mm, 160mm, 6 ¹ / ₄ "
15	130-750-150	1 x	Micro Adson Monopolar Forceps, 1x2 teeth, insulated, 150mm, 6"



260-990-005 ENDOSCOPIC FACELIFT-FOREHEAD SET

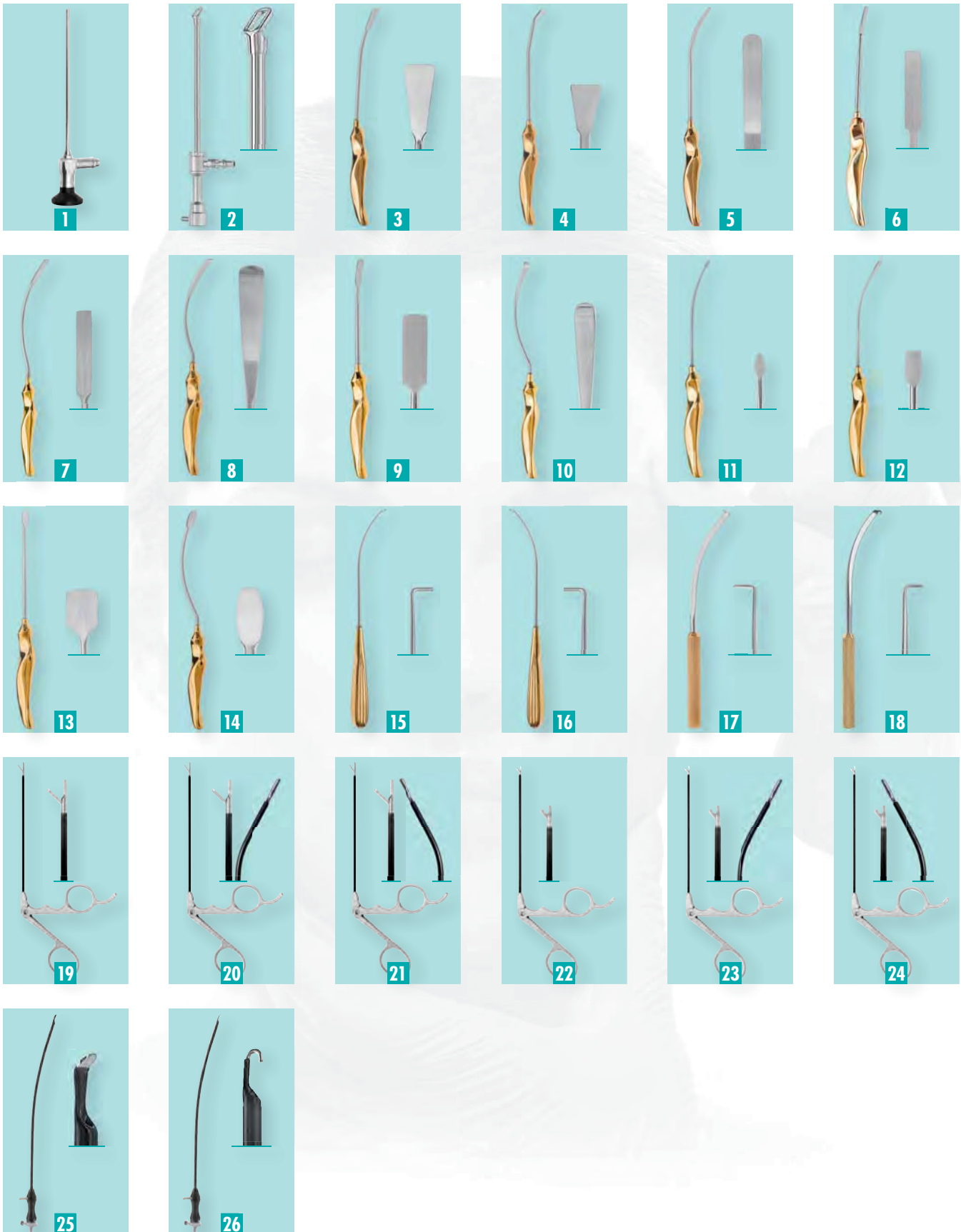

260-990-005 ENDOSCOPIC FACELIFT-FOREHEAD SET

Picture	Order number	Quantity	Description
1	260-104-030	1 x	SHAPER Telescope for Plastic Endoscopy, 30° wide angle, Ø 4mm, WL 175mm, 6 ⁷ / ₈ "
2	260-501-180	1 x	SHAPER Sheath, angled spatula tip, with rotating stopcock, Ø 4mm, 180mm, 7"
3	260-001-101	1 x	SHAPER Scalp Elevator, slightly curved, 12.5mm wide, with Ergo Handle, 240mm, 9 ¹ / ₂ "
4	260-001-102	1 x	SHAPER Scalp Elevator, medium curved, 12.5mm wide, with Ergo Handle, 240mm, 9 ¹ / ₂ "
5	260-002-101	1 x	SHAPER Endoforehead Elevator, curved, 7mm wide, with Ergo Handle, 240mm, 9 ¹ / ₂ "
6	260-020-101	1 x	SHAPER Frontotemporal Dissector, curved, 9 ¹ / ₂ inch, 6.5mm wide, with Ergo Handle, WL 240mm, 9 ¹ / ₂ "
7	260-023-100	1 x	SHAPER Frontoglabellar Dissector, s-shaped, 7mm wide, with Ergo Handle, 265mm, 10 ¹ / ₂ "
8	260-024-100	1 x	SHAPER Arcus Marginalis Dissector, s-shaped, 10mm wide, with Ergo Handle, 240mm, 9 ¹ / ₂ "
9	260-020-100	1 x	SHAPER Frontotemporal Dissector, straight, 10mm wide, with Ergo Handle, 225mm, 8 ⁷ / ₈ "
10	260-025-100	1 x	SHAPER Periosteal Dissector, s-shaped, 5mm wide, with Ergo Handle, 240mm, 9 ¹ / ₂ "
11	260-003-101	1 x	SHAPER Nerve Dissector, slightly curved, with Ergo Handle, 240mm, 9 ¹ / ₂ "
12	260-004-101	1 x	SHAPER Orbital Rim Dissector, medium curved, with Ergo Handle, 240mm, 9 ¹ / ₂ "
13	260-022-100	1 x	SHAPER Temporal Dissector, straight, with Ergo Handle, 235mm, 9 ¹ / ₄ "
14	260-021-100	1 x	SHAPER Parietal Periosteal Elevator, curved, with Ergo Handle, 250mm, 10"
15	260-003-002	1 x	SHAPER Nerve Hook, right curved, 240mm, 9 ¹ / ₂ "
16	260-003-003	1 x	SHAPER Nerve Hook, left curved, 240mm, 9 ¹ / ₂ "
17	260-008-003	1 x	SHAPER Nerve Protector, right curved, 170mm, 6 ² / ₃ "
18	260-008-002	1 x	SHAPER Nerve Protector, left curved, 170mm, 6 ² / ₃ "
19	260-204-600	1 x	SHAPER Grasping Forceps, straight, short strong jaw, insulated shaft, Ø 2.7mm, WL 125mm, 5"
20	260-204-400	1 x	SHAPER Grasping Forceps, right curved, short strong jaw, insulated shaft, Ø 2.7mm, WL 125mm, 5"
21	260-204-300	1 x	SHAPER Grasping Forceps, left curved, short strong jaw, insulated shaft, Ø 2.7mm, WL 125mm, 5"
22	260-203-600	1 x	SHAPER Hook Scissors, straight, insulated shaft, Ø 2.7mm, WL 125mm, 5"
23	260-203-700	1 x	SHAPER Hook Scissors, right curved, insulated shaft, Ø 2.7mm, WL 125mm, 5"
24	260-203-800	1 x	SHAPER Hook Scissors, left curved, insulated shaft, Ø 3.4mm, WL 125mm, 5"
25	260-702-000	1 x	Spatula Electrode, curved, with suction and trumpet valve, 270mm, 10 ² / ₃ "
26	260-700-000	1 x	J-Hook Electrode, curved, with suction and trumpet valve, 270mm, 10 ² / ₃ "



SCISSORS



Standard Scissors

- Reliable high quality scissors with standard characteristics
- Matt finished surface



Tungsten Carbide (TC) Scissors

- Welded Tungsten Carbide inserts
- Long-lasting cutting edges
- Suitable for harder materials
- Matt finished surface
- Gold plated rings



Super-Cut (SC) Scissors

- Unique with razor-sharp edge to cut smoothly through tissue
- Lower blade with very fine serrations preventing tissue slippage
- Mirror finished surface
- Black coated rings



CeraCut[®] Scissors

- Very high corrosion and rust resistance
- Significant extended durability
- Lower blade with very fine serrations preventing tissue slippage
- Non-reflective surface
- Harder surface
- Razor-sharp edges
- Black ceramic coating



Tungsten Carbide (TC) Super-Cut (SC) Scissors

- Combines the advantages of TC Scissors with the outstanding cutting performance of Super-Cut Scissors
- Lower blade with very fine serrations to prevent tissue slippage
- Matt finish surface with bead-blasted shanks
- Gold plated rings

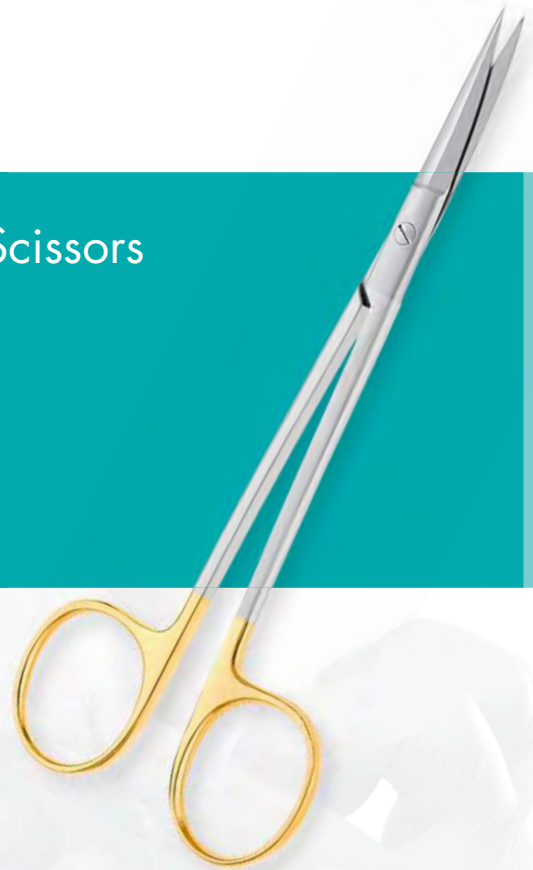

Tungsten Carbide (TC) CeraCut® Scissors

- Harder surface, combined with welded TC inserts
- Combines the advantages of TC Scissors with the excellent features of CERA-CUT Scissors
- Lower blade with very fine serrations to prevent tissue slippage
- Black ceramic coating
- Gold plated rings

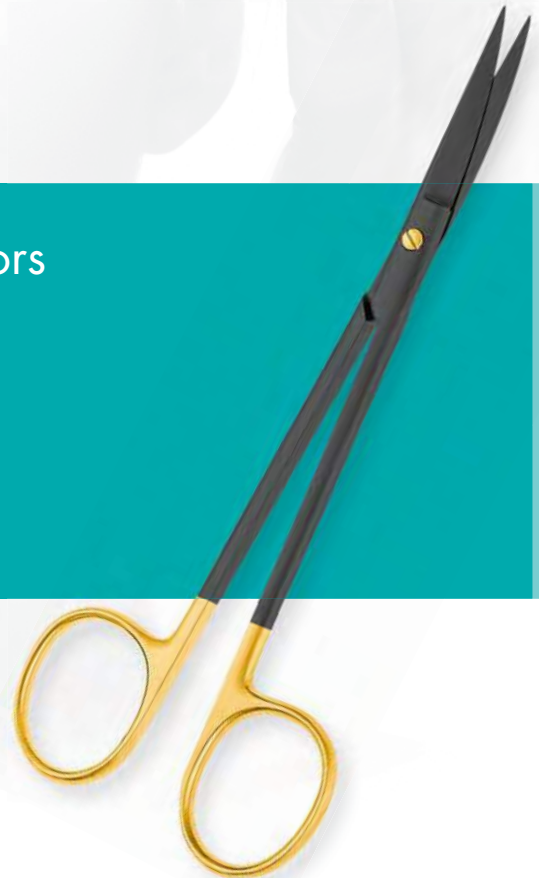



1:1

Straight

190mm, 7 1/2"

121-336-190

Curved

121-337-185

GORNEY
Super-Cut Facelift Scissors
with bevelled blades



1:1



1:1

Straight

190mm, 7 1/2"

120-586-190

Curved

120-587-190

GORNEY
TC Facelift Scissors
with bevelled blades



1:1

Straight

190mm, 7 1/2"

121-334-190

Curved

121-335-190

RZ-GORNEY
Super-Cut Facelift Scissors
with bevelled blades



1:1



1:1

230mm, 9"

121-334-230

121-335-230



SCISSORS

Facelift
Scissors



1:1



1:1



1:1



1:1

170mm, 6 3/4"

190mm, 7 1/2"

230mm, 9"

Straight

120-584-170

120-584-190

120-584-230

Curved

120-585-170

120-585-190

120-585-230

RZ-GORNEY

TC Facelift Scissors
with bevelled blades



1:1



1:1

190mm, 7 1/2"

Straight

123-584-190

Curved

123-585-190

RZ-GORNEY

CeraCut® Facelift Scissors
with bevelled blades





1:1

Straight

190mm, 7¹/₂"

121-342-190

Curved

121-343-190

GORNEY-FREEMAN
Super-Cut Facelift Scissors
with bevelled blades



1:1



1:1

Straight

190mm, 7¹/₂"

120-568-190

Curved

120-569-190

GORNEY-FREEMAN
TC Facelift Scissors
with bevelled blades



1:1



1:1

Straight

170mm, 6³/₄"

121-344-170

Curved

121-345-170

RZ-GORNEY-FREEMAN
Super-Cut Facelift Scissors
with bevelled blades



1:1



1:1

190mm, 7¹/₂"

121-344-190

121-345-190



1:1

230mm, 9"

121-344-230

121-345-230



SCISSORS

Facelift
Scissors



1:1

170mm, 6 3/4"

Straight

120-572-170

Curved

120-573-170



1:1



1:1



1:1

190mm, 7 1/2"

230mm, 9"

120-572-190

120-572-230

120-573-190

120-573-230

RZ-GORNEY-FREEMAN

TC Facelift Scissors
with bevelled blades



1:1



1:1

230mm, 9"

Curved

120-576-230



1:1



1:1

205mm, 8"

Curved

120-573-205

GORNEY-FREEMAN

TC Facelift Scissors, double angled shanks
with bevelled blades

METZENBAUM-FREEMAN

TC SMAS Platysma Facelift Scissors, delicate





1:1



1:1

145mm, 5³/₄"



1:1

180mm, 7"

Straight	121-326-145	121-326-180
Curved	121-327-145	121-327-180

KAYE
Super-Cut Facelift Scissors



1:1



1:1

145mm, 5³/₄"



1:1

180mm, 7"

Straight	120-570-145	120-570-180
Curved	120-571-145	120-571-180

KAYE
TC Facelift Scissors



SCISSORS

Facelift
Scissors



1:1



1:1



1:1



1:1

170mm, 6 3/4"

190mm, 7 1/2"

230mm, 9"

Straight

121-310-170

121-310-190

121-310-230

Curved

121-311-170

121-311-190

121-311-230

RZ-KAYE
Super-Cut Facelift Scissors



1:1



1:1



1:1



1:1

170mm, 6 3/4"

190mm, 7 1/2"

230mm, 9"

Straight

120-528-170

120-528-190

120-528-230

Curved

120-529-170

120-529-190

120-529-230

RZ-KAYE
TC Facelift Scissors





1:1

Curved

190mm, 7 1/2"

123-311-190

123-311-190

123-311-190

123-311-190

123-311-190

123-311-190

123-311-190

123-311-190

123-311-190

123-311-190

123-311-190

123-311-190

123-311-190

123-311-190

123-311-190

123-311-190

123-311-190

123-311-190

123-311-190

123-311-190

123-311-190

123-311-190

123-311-190

123-311-190

123-311-190

123-311-190

123-311-190

123-311-190

123-311-190

123-311-190

123-311-190

123-311-190

123-311-190

123-311-190

123-311-190

123-311-190

123-311-190

123-311-190

123-311-190

123-311-190

123-311-190

123-311-190

123-311-190

123-311-190

123-311-190

123-311-190

123-311-190

123-311-190

123-311-190

123-311-190

123-311-190

123-311-190

123-311-190

123-311-190

123-311-190

123-311-190

123-311-190

123-311-190

123-311-190

123-311-190

123-311-190



straight shanks

Regular



splayed shanks

Freeman

RZ-KAYE
CeraCut® Facelift Scissors



1:1

Straight

121-328-180

Curved

121-329-180

RZ-KAYE-FREEMAN
Super-Cut Facelift Scissors



1:1

180mm, 7"

121-328-180

121-329-180



1:1

Straight

120-310-180

Curved

120-311-180

KAYE-FREEMAN
TC Facelift Scissors



1:1

180mm, 7"

120-310-180

120-311-180



SCISSORS

Facelift
Scissors



1:1



1:1

180mm, 7"

Curved

122-311-180

KAYE-FREEMAN

TC Super-Cut Facelift Scissors
with one serrated blade



1:1



1:1



1:1

170mm, 6 3/4"

190mm, 7 1/2"

Curved

121-077-170

121-077-205

REES

Super-Cut Facelift Scissors, bevelled blade





	170mm, 6 ³ / ₄ "	190mm, 7 ¹ / ₂ "
Straight	120-576-170	120-576-190
Curved	120-577-170	120-577-205

REES
TC Facelift Scissors, bevelled blade



	200mm, 8"
Straight	123-300-200
Curved	123-301-200

REES
CeraCut® Facelift Scissors



	170mm, 6 ² / ₃ "	15mm blade 180mm, 6"	25mm blade 180mm, 6"
Straight	122-576-170	120-092-182	120-093-182
Curved	122-577-170		

REES
TC Super-Cut Facelift Scissors

PADDLE
Facelift Scissors
with one serrated blade

Not for sale in the USA and Canada



SCISSORS

Facelift
Scissors



1:1



1:1



1:1

170mm, 6 3/4"

200mm, 8"

Straight

121-300-170

121-300-200

Curved

121-301-170

121-301-200

ASTON
Super-Cut Facelift Scissors



1:1



1:1



1:1

170mm, 6 3/4"

200mm, 8"

Straight

120-500-170

120-500-200

Curved

120-501-170

120-501-200

ASTON
TC Facelift Scissors





1:1



1:1

170mm, 6 ³/₄"



1:1

200mm, 8"

Straight	121-304-170	121-304-200
Curved	121-305-170	121-305-200

MATARASSO
Super-Cut Facelift Scissors



1:1



1:1

170mm, 6 ³/₄"



1:1

200mm, 8"

Curved	123-305-170	123-305-200
---------------	-------------	-------------

MATARASSO
TC CeraCut® Facelift Scissors



SCISSORS

Facelift
Scissors



1:1

Curved

180mm, 7"

121-211-180



1:1



1:1

200mm, 8"

121-211-200



1:1

230mm, 9"

121-211-230

METZENBAUM-FREEMAN
Super-Cut Facelift Scissors with
bevelled blades



1:1

Curved

225mm, 9"

123-505-225



1:1



1:1

Straight

180mm, 7"

120-574-170



1:1

KLAPPER
TC CeraCut® Facelift Scissors
with bevelled blades

TESSIER
TC Facelift Scissors





1:1

Curved

145mm, 5³/₄"

121-575-145

AUFRICHT
Super-Cut Facelift Scissors



1:1



1:1

Curved

145mm, 5³/₄"

120-575-145

AUFRICHT
TC Facelift Scissors



1:1

Kaye pattern

150mm, 6"

121-214-150

200mm, 8"

121-214-200

BOETTLER (Kaye pattern)
Super-Cut Facelift Scissors, reinforced,
round shanks on the tip



1:1

Sims pattern

200mm, 8"

121-204-200

BOETTLER (Sims pattern)
Super-Cut Facelift Scissors, reinforced,
round shanks on the tip



SCISSORS

Facelift
Scissors



Straight

150mm, 6"

120-338-150

CASTANARES
Facelift Scissors, square blades



1:1



Straight

150mm, 6"

121-312-150

CASTANARES
Super-Cut Facelift Scissors



1:1



1:1

Curved

121-313-150



Straight

150mm, 6"

120-538-150

CASTANARES
TC Facelift Scissors



1:1

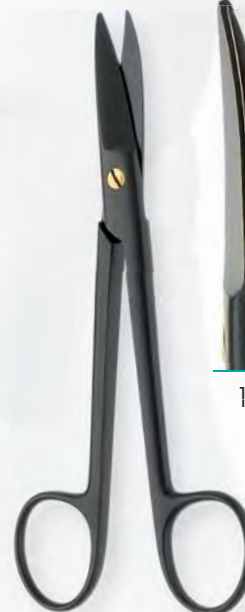

Straight

150mm, 6"

123-312-150

CASTANARES
CeraCut® Facelift Scissors



1:1



1:1

Curved

123-313-150





1:1

Curved

135mm, 5¹/₃"

121-139-135

FOMON-SABER
Super-Cut Facelift Scissors



1:1



1:1

Curved

145mm, 5³/₄"

121-137-145

KAHN
Super-Cut Facelift Scissors



1:1



1:1

Curved

140mm, 5¹/₂"

120-591-140

GREGORY
TC Facelift Scissors, slightly curved,
slightly bevelled blade



1:1



1:1

Curved

180mm, 7"

120-595-180

STELLA
Super-Cut Facelift Scissors, S-curved,
slightly bevelled blade





SCISSORS

Facelift
Scissors



Curved

180mm, 7"

120-173-180

DAVIS
Facelift Scissors



1:1



Curved

180mm, 7"

121-313-170

RZ-DAVIS
Super-Cut Facelift Scissors



1:1



1:1



Curved

180mm, 7"

120-209-180

BOETTCHER
Facelift Scissors



1:1



Curved

180mm, 7"

121-209-180

BOETTCHER
Super-Cut Facelift Scissors



1:1



1:1





GOLDMAN-FOX

Gum Scissors, one serrated blade, 130mm, 5¹/₈"

Straight	120-666-130
----------	-------------

Curved	120-667-130
--------	-------------



GOLDMAN-FOX

TC Scissors, one serrated blade, 130mm, 5¹/₈"

Straight	120-966-130
----------	-------------

Curved	120-967-130
--------	-------------



PAR TYPE

TC Scissors, serrated blade, 115mm, 4¹/₂"

Straight	120-323-110
----------	-------------



PAR TYPE

Super-Cut Scissors

Straight, 110mm, 4 ¹ / ₃ "	121-330-110
--	-------------

Curved, 110mm, 4 ¹ / ₃ "	121-331-110
--	-------------

Curved, 150mm, 6"	121-331-150
-------------------	-------------



KAYE

TC Blepharoplasty Scissors, serrated, 115mm, 4¹/₂"

Curved	120-571-115
--------	-------------



KAYE XL

TC Blepharoplasty Scissors, 135mm, 5¹/₃"

Curved	120-535-135
--------	-------------



SCISSORS

Tenotomy Scissors

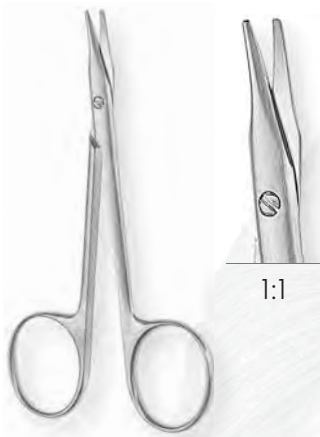

1:1

STEVENS

Tenotomy Scissors, blunt, 105mm, 4^{1/8}"

Straight	120-092-105
Curved	120-093-105



1:1

STEVENS

Tenotomy Scissors, blunt, 115mm, 4^{1/2}"

Straight	120-092-115
Curved	120-093-115



1:1

STEVENS

Tenotomy Scissors, blunt, 125mm, 5"

Straight	120-092-125
Curved	120-093-125

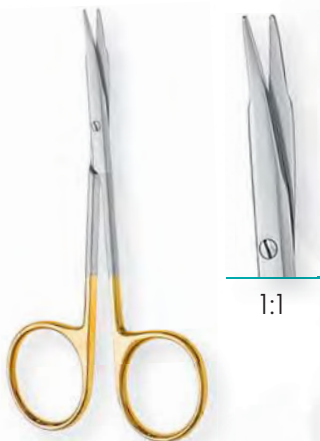

1:1

STEVENS

TC Tenotomy Scissors, sharp, 110mm, 4^{1/3}"

Straight	122-296-110
Curved	122-297-110



1:1

STEVENS

Super-Cut Tenotomy Scissors, blunt, 105mm, 4^{1/8}"

Curved	121-093-105
--------	-------------



1:1

STEVENS

Super-Cut Tenotomy Scissors, blunt, 115mm, 4^{1/2}"

Straight	121-196-110
Curved	121-197-110





1:1

STEVENS

CeraCut® Tenotomy Scissors, sharp, 110mm, 4^{1/3}"

Straight	123-196-110
----------	-------------

Curved	123-197-110
--------	-------------



1:1

STEVENS

CeraCut® Tenotomy Scissors, blunt, 120mm, 4^{3/4}"

Straight	123-196-120
----------	-------------

Curved	123-197-120
--------	-------------



1:1

STEVENS

CeraCut® Tenotomy Scissors, sharp, 150mm, 6"

Sharp	123-089-150
-------	-------------

Blunt	123-197-150
-------	-------------



1:1

JAMESON

Tenotomy Scissors, curved

150mm, 6"	120-315-150
-----------	-------------

180mm, 7"	120-315-180
-----------	-------------



1:1

JAMESON

Super-Cut Scissors, 150mm, 6"

Curved	121-315-150
--------	-------------



1:1

GREENBERG-PAR

TC Scissors, serrated, 115mm, 4^{1/2}"

Curved	120-593-115
--------	-------------



SCISSORS

Strabismus Scissors



1:1

STRABISMUS

Scissors, blunt, 115mm, 4¹/₂"

Straight	120-094-115
Curved	120-095-115



1:1

STRABISMUS

TC Scissors, blunt, 115mm, 4¹/₂"

Curved	120-595-115
--------	-------------

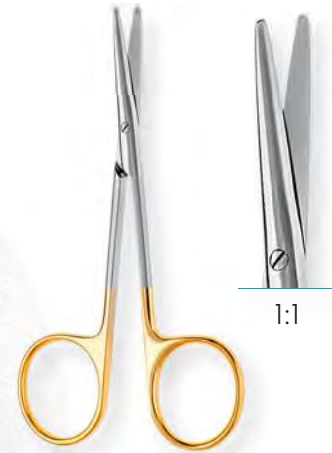

1:1

STRABISMUS

TC Super-Cut Scissors, 115mm, 4¹/₂"

Straight	122-594-115
Curved	122-595-115

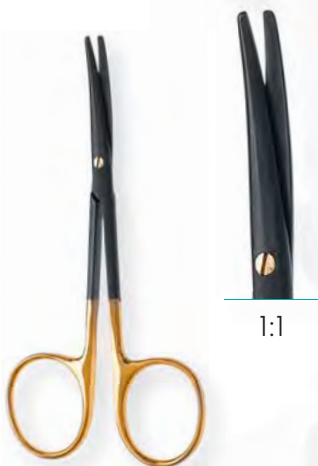

1:1

STRABISMUS

TC CeraCut® Scissors, blunt, 115mm, 4¹/₂"

Curved	123-595-115
--------	-------------



1:1

STRABISMUS

Super-Cut Scissors, blunt, 115mm, 4¹/₂"

Straight	121-094-115
Curved	121-095-115



1:1

LAHEY

Scissors, 145mm, 5³/₄"

Curved	120-330-145
--------	-------------





1:1

REYNOLDS

Super-Cut Tenotomy Scissors, 125mm, 5"

Curved

121-318-125



1:1

REYNOLDS

TC CeraCut® Tenotomy Scissors, 125mm, 5"

Curved

123-518-125



1:1

RAGNELL

Undermining and Dissecting Scissors, 130mm, 5 1/4"

Slightly curved

120-065-130



1:1

RAGNELL

SC Undermining and Dissecting Scissors, 130mm, 5 1/4"

Slightly curved

121-065-130



1:1

RAGNELL (KILNER)

Undermining and Dissecting Scissors, curved

120mm, 4 3/4"

120-065-120

150mm, 6"

120-065-150

180mm, 7"

120-065-180

200mm, 8"

120-065-200

230mm, 9"

120-065-230



1:1

RAGNELL (KILNER)

SC Undermining and Dissecting Scissors, curved

150mm, 6"

121-332-150

180mm, 7"

121-332-180

200mm, 8"

121-332-200



SCISSORS

Iris Type Scissors



1:1

IRIS

Scissors, with large rings, 100mm, 4"

Straight	120-082-100
Curved	120-083-100



1:1

IRIS

Scissors, 115mm, 4¹/₂"

Straight	120-080-115
Curved	120-081-115



1:1

IRIS

Super-Cut Scissors, 110mm, 4¹/₃"

Straight	121-070-110
Curved	121-071-110



1:1

IRIS

CeraCut® Scissors, 115mm, 4¹/₂"

Straight	123-070-115
Curved	123-071-115



1:1

GRADLE

Scissors, sharp, 120mm, 4³/₄"

Curved	120-134-120
--------	-------------



1:1

GRADLE

Super-Cut Scissors, sharp, 120mm, 4³/₄"

Straight	121-134-120
----------	-------------





1:1

JOSEPH
Dissecting Scissors, sharp, 150mm, 6"

Curved 120-059-140



1:1

JOSEPH
TC CeraCut® Dissecting Scissors, 145mm, 5³/₄"

Straight 123-526-145

Curved 123-527-145



1:1

BEUS-JOSEPH
Dissecting Scissors, 140mm, 5¹/₂"

S-Curved 120-283-140



1:1

PECK-JOSEPH
TC Dissecting Scissors, double serrated, 140mm, 5¹/₂"

Curved 120-561-140

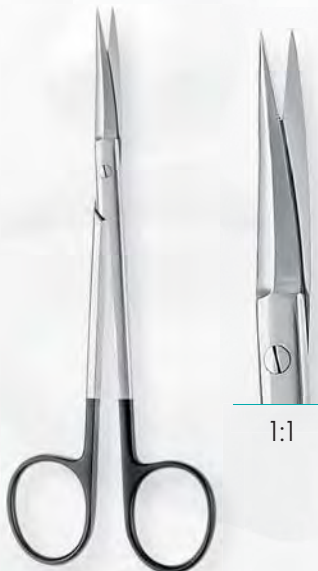

1:1

PECK-JOSEPH
Super-Cut Dissecting Scissors, 140mm, 5¹/₂"

Straight 121-060-140

Curved 121-061-140



1:1

PECK-JOSEPH
TC Super-Cut Dissecting Scissors, 140mm, 5¹/₂"

Curved 122-561-140



KELLY
Surgical Scissors, 160mm, 6^{1/4}"

Straight	120-046-160
Curved	120-047-160



SHEA
Dissecting Scissors, sharp, 120mm, 4^{3/4}"

Curved	120-141-120
--------	-------------



Nerve Dissecting Scissors
Sharp, 150mm, 6"

Straight	120-120-150
Curved	120-121-150



BONN
Scissors, extra delicate blades, 90mm, 3^{1/2}"

Curved	120-073-080
--------	-------------

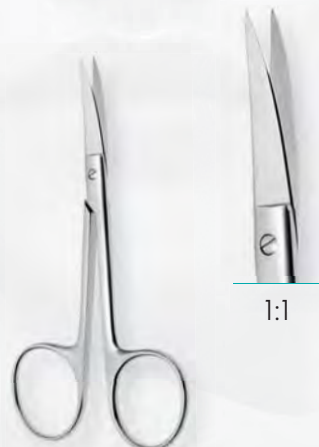

SEALY
Scissors, sharp, 105mm, 4^{1/8}"

Curved	120-079-105
--------	-------------

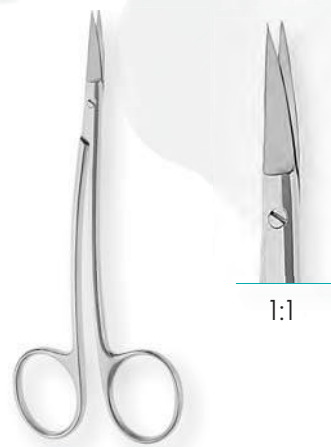

LAGRANGE
Scissors, 1 serrated blade, 115mm, 4^{1/2}"

S-Curved	120-305-105
----------	-------------



1:1

FOMON

Lower Lateral Nasal Scissors, 110mm, 4¹/₃"

Strongly-Curved

120-131-110



1:1

FOMON

Super-Cut Lower Lateral Nasal Scissors, 110mm, 4¹/₃"

Strongly-Curved

121-131-110



1:1

FOMON

Super-Cut Lower Lateral Nasal Scissors, 125mm, 5"

Strongly-Curved

121-339-127

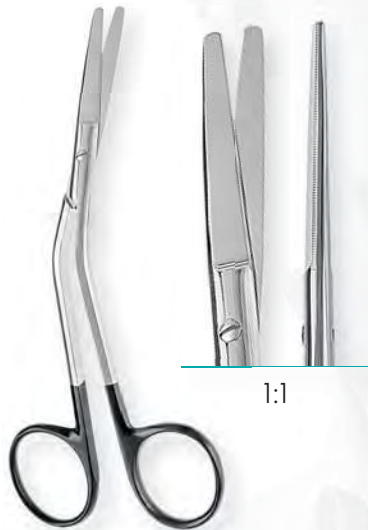

1:1

FOMON

Super-Cut Dorsal Scissors, 145mm, 5³/₄"

Knee bent

121-280-145



1:1

FOMON

Lower Lateral Nasal Scissors, 170mm, 6²/₃"

Strongly-Curved

120-339-170



1:1

Enderectomy Super-Cut Dissecting Scissors, 180mm, 7"

Curved

121-320-180



SCISSORS

Rhinoplasty Scissors



1:1

DANIELS

Nasal Scissors, 90mm, 3 1/2"

40° upwards angled

120-411-090



1:1

WILMER

Utility Scissors, 100mm, 4"

Angled on flat

120-084-100



1:1

QUINTA

TC Nasal Scissors, angled shanks, serrated, 135mm, 5 1/3"

Angled upwards

122-411-135



1:1

BEUSE

Nasal Scissors, blunt, 110mm, 4 1/3"

Slightly-Curved

120-281-110



1:1

BEUSE

Nasal Scissors, sharp, 130mm, 5 1/8"

Slightly-Curved

120-281-130



1:1

REES

Bulldog Scissors, 130mm, 5 1/8"

Slightly-Curved

120-283-130





CAPLAN
Nasal Scissors, 220mm, 8²/₃"

Straight	120-286-220
Curved	120-287-220



GORNEY
Nasal Scissors, 220mm, 8²/₃"

Straight	120-588-220
----------	-------------



COTTLE
Super-Cut Dorsal Scissors, 170mm, 6²/₃"

Knee bent	121-290-165
-----------	-------------



HEYMANN
TC Nasal Scissors, one serrated blade, 180mm, 7"

Straight	120-585-180
----------	-------------



HEYMANN
TC Nasal Scissors, both blades serrated, 180mm, 7"

Straight	120-583-180
----------	-------------



1:1

BABY-METZENBAUM

Scissors, 115mm, 4^{1/2}"

Straight	120-110-115
Curved	120-111-115



1:1

BABY-METZENBAUM

TC Scissors, 115mm, 4^{1/2}"

Straight	120-510-115
Curved	120-511-115



1:1

BABY-METZENBAUM

Super-Cut Scissors, curved

115mm, 4 ^{1/2} "	121-317-110
145mm, 5 ^{3/4} "	121-317-145



1:1

BABY-METZENBAUM

CeraCut® Scissors, curved

110mm, 4 ^{1/3} "	123-317-110
145mm, 5 ^{3/4} "	123-317-145



1:1



1:1

METZENBAUM
TC Dissecting Scissors

	Straight	Curved
145mm, 5 ³ / ₄ "	120-510-145	120-511-145
180mm, 7"	120-510-180	120-511-180
200mm, 8"	120-510-200	120-511-200
230mm, 9"	120-510-230	120-511-230
280mm, 11"	120-510-280	120-511-280

METZENBAUM
Super-Cut Dissecting Scissors, curved

145mm, 5 ³ / ₄ "	121-111-145
180mm, 7"	121-111-180
200mm, 8"	121-111-200
230mm, 9"	121-111-230
280mm, 11"	121-111-280



1:1



1:1

METZENBAUM
TC Dissecting Scissors, sharp

	Straight	Curved
145mm, 5 ³ / ₄ "	120-514-145	120-515-145
180mm, 7"	120-514-180	120-515-180
230mm, 9"	120-514-230	120-515-230

METZENBAUM
CeraCut® Dissecting Scissors, curved

145mm, 5 ³ / ₄ "	123-111-145
180mm, 7"	123-111-180
200mm, 8"	123-111-200



1:1

METZENBAUM-FINO
TC Dissecting Scissors, 145mm, 5³/₄"

Straight	120-520-145
Curved	120-521-145



1:1

METZENBAUM-FINO
TC Dissecting Scissors, sharp, 145mm, 5³/₄"

S-Curved	120-527-145
----------	-------------



1:1

METZENBAUM-FINO
Super-Cut Dissecting Scissors, curved, blunt

145mm, 5 ³ / ₄ "	121-153-145
180mm, 7"	121-153-180
200mm, 8"	121-153-200
230mm, 9"	121-153-230



1:1

METZENBAUM-FINO
CeraCut® Dissecting Scissors, sharp, 145mm, 5³/₄"

Straight	123-152-145
Curved	123-153-145



1:1

TOENNIS-ADSON
TC Dissecting Scissors, curved

170mm, 6 ² / ₃ "	120-531-170
--	-------------



1:1

TOENNIS-ADSON
Super-Cut Dissecting Scissors, curved

170mm, 6 ² / ₃ "	121-319-170
--	-------------

Mayo Scissors



1:1

MAYO
TC Surgical Scissors

	Straight	Curved
145mm, 5 ³ / ₄ "	120-506-145	120-507-145
170mm, 6 ² / ₃ "	120-506-170	120-507-170
230mm, 9"	120-506-230	120-507-230



1:1

MAYO
CeraCut® Surgical Scissors, curved

170mm, 6 ² / ₃ "	123-031-170
--	-------------



1:1

MAYO
Super-Cut Surgical Scissors

	Straight	Curved
145mm, 5 ³ / ₄ "	121-030-145	121-031-145
170mm, 6 ¹ / ₂ "	121-030-170	121-031-170
230mm, 9"	121-030-230	121-030-230



1:1

MAYO-STILLE
CeraCut® Surgical Scissors, curved

170mm, 6 ² / ₃ "	123-037-170
--	-------------

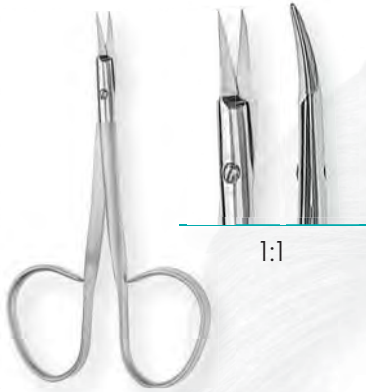

1:1

STITCH

Removal Scissors, 100mm, 4"

Curved

120-078-100

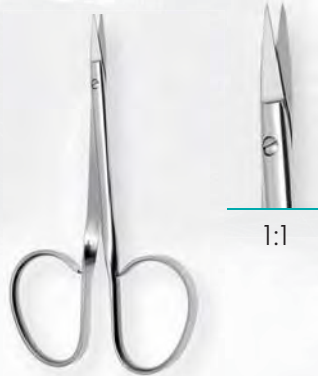

1:1

IRIS

Tenotomy Scissors, sharp, 95mm, 3³/₄"

Straight

120-080-095

Curved

120-081-095



1:1

IRIS

Tenotomy Scissors, sharp, 105mm, 4¹/₈"

Straight

120-078-105

Curved

120-083-105

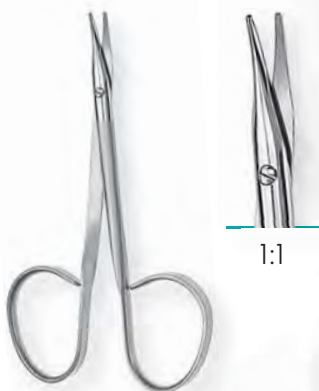

1:1

STEVENS

Tenotomy Scissors, blunt, 100mm, 4"

Straight

120-098-100

Curved

120-099-100



1:1

STEVENS

Super-Cut Tenotomy Scissors, blunt, 100mm, 4"

Straight

121-098-100

Curved

121-099-100



1:1

STEVENS

Super-Cut Tenotomy Scissors, sharp, 100mm, 4"

Curved

121-091-095





WALTON
Tenotomy Scissors, sharp, 100mm, 4"

Curved	120-091-095
--------	-------------



GRADLE-WALTON
Scissors, sharp, 115mm, 4 1/2"

Straight	120-132-200
Curved	120-133-200

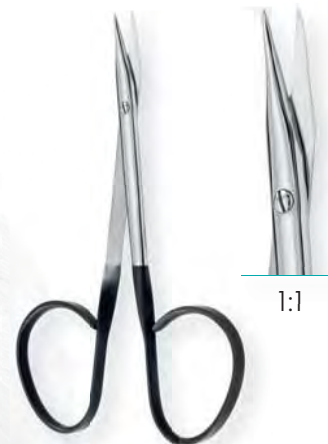

GRADLE-WALTON
Super-Cut Scissors, sharp, 115mm, 4 1/2"

Straight	121-132-200
Slightly curved	121-133-200



KAYE
Blepharoplasty Scissors, serrated, 115mm, 4 1/2"

Curved	120-135-115
--------	-------------



WALDRAM
Super-Cut Scissors, blunt, 118mm, 4^{2/3}"

Curved 121-011-125



STRABISMUS
Super-Cut Scissors, blunt, 120mm, 4^{3/4}"

Straight 121-100-120
Slightly curved 121-101-120



STEVENS
Super-Cut Tenotomy Scissors, blunt, 125mm, 5"

Curved 121-012-125



IRIS
Super-Cut Scissors, sharp, 100mm, 4"

Curved 121-081-100



JABALEY
Super-Cut Scissors, sharp, 130mm, 5^{1/8}"

Curved 121-089-130



STEVENS
Super-Cut Scissors, with splayed shanks, 120mm, 4^{1/2}"

Straight 121-296-120





1:1

STEVENS
Super-Cut Dissecting Scissors

Straight



Curved



1:1

STRABISMUS
Super-Cut Dissecting Scissors, blunt, 115mm, 4 1/2"

Straight 121-186-115

Curved 121-187-115

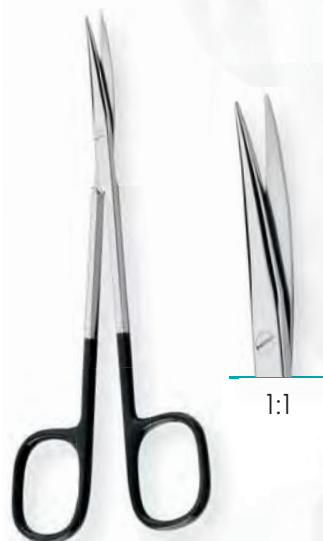

1:1

REYNOLDS-JAMESON
Super-Cut Vessel Scissors, sharp, 140mm, 5 1/2"

Straight 121-190-140

Curved 121-191-140



1:1

METZENBAUM
Super-Cut Dissecting Scissors, 145mm, 5 3/4"

Straight 121-188-145

Curved 121-189-145



SCISSORS

Ligature Scissors



RZ
TC Ligature Scissors, curved, serrated blade

115mm, 4 ¹ / ₂ "	120-611-115
140mm, 5 ¹ / ₂ "	120-611-140
180mm, 7"	120-611-180
230mm, 9"	120-611-230



SPENCER
Ligature Scissors, 90mm, 3¹/₂"

Straight	120-220-090
----------	-------------



O'BRIEN
Suture Scissors, 120mm, 4³/₄"

Angled	120-084-120
--------	-------------

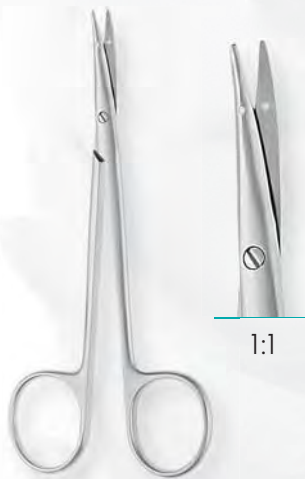

LITTLER
Delicate Scissors, sharp, with suture hole, 115mm, 4¹/₂"

Slightly Curved	120-061-115
-----------------	-------------



LITTLER
Super-Cut Delicate Scissors, sharp, with suture hole, 115mm, 4¹/₂"

Slightly Curved	121-061-115
-----------------	-------------





1:1

POTTS-SMITH

CeraCut® TC Vascular Scissors, 190mm, 7^{1/2}"

60° angled

123-583-190



1:1

TC UNIVERSAL

TC Wire & Plate Scissors, serrated, 120mm, 5"

Straight

120-565-120



1:1

LISTER

Bandage Scissors

140mm, 5^{1/2}"

190-165-140

180mm, 7"

190-165-180

180mm, 7" - Super-Cut

191-165-180



1:1

WALDEN-MARSHALL

Breast Dissecting Scissors, curved

230mm, 9"	120-580-230
250mm, 10"	120-580-250
305mm, 12"	120-580-305
355mm, 14"	120-580-355



Breast dissecting scissors with double-sided cutting edges, curved. The different lengths provide adequate access when using a transaxillary approach for breast augmentation.

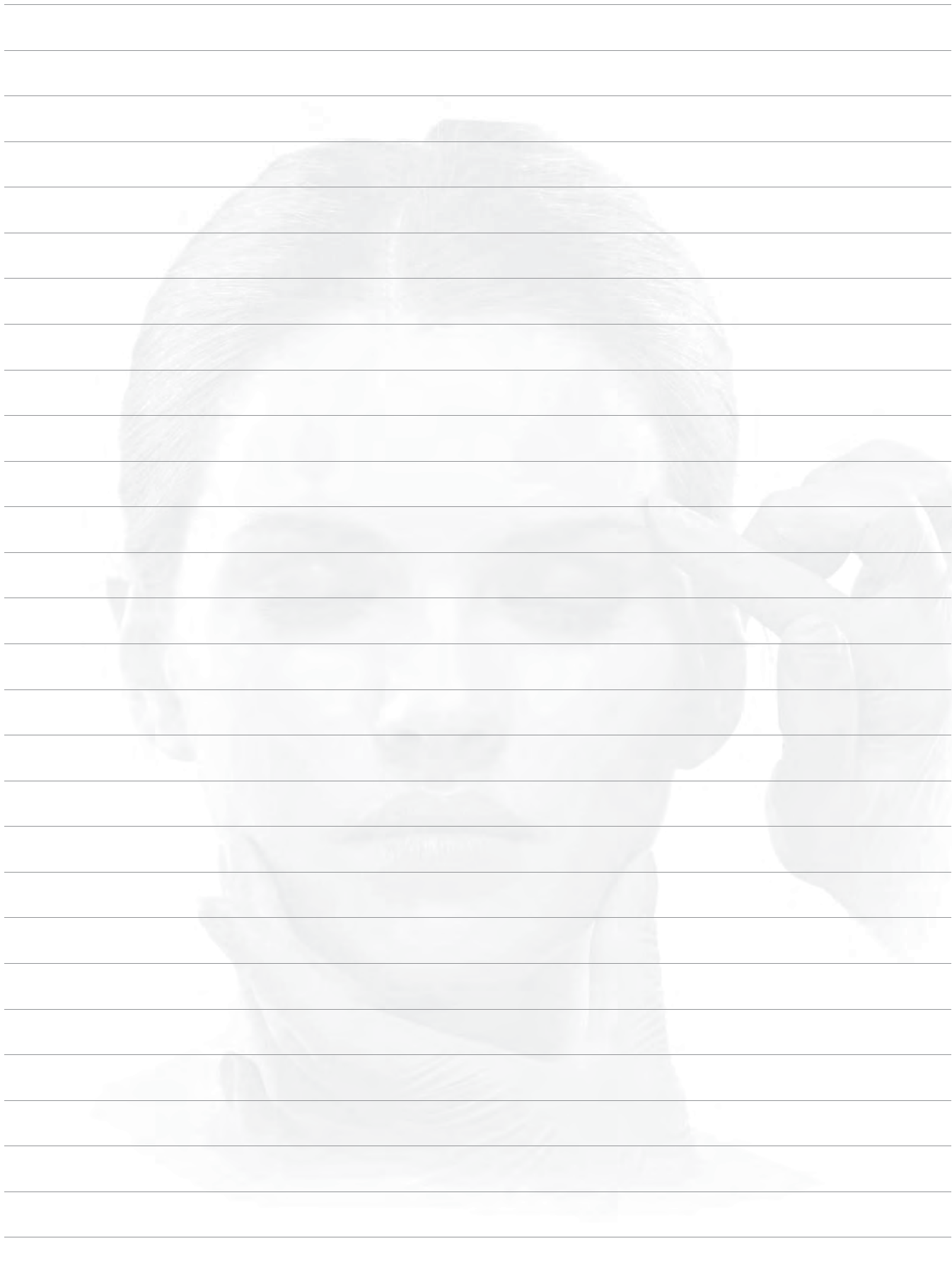



FORCEPS



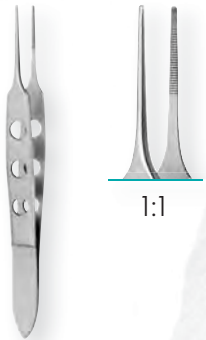

1:1

BISHOP-HARMON

Dressing Forceps, 0.5mm tip, 85mm, 3¹/₃"

Straight

400-018-005

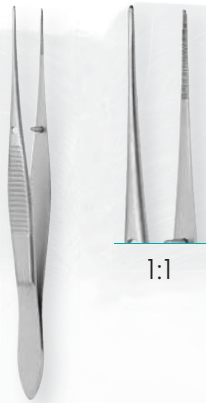

1:1

RZ

Delicate Dressing Forceps, 0.7mm wide, 100mm, 4"

Straight

130-490-100

Slightly curved

130-491-100

Strongly curved

130-492-100



1:1

GRAEFE

Dressing Forceps, 100mm, 4"

Straight

130-500-100

Slightly curved

130-501-100

Strongly curved

130-502-100



1:1

ADSON

Dressing Forceps, serrated

120mm, 4³/₄"

130-026-120

150mm, 6"

130-026-150



1:1

MICRO-ADSON

Dressing Forceps, serrated

120mm, 4³/₄"

130-548-120

150mm, 6"

130-548-150



1:1

STEVENS

Dressing Forceps, 105mm, 4¹/₈"

Slightly curved

130-511-110



LUCAE
Dressing Aural Forceps, bayonet shape, 140mm, 5¹/₂"

Serrated	410-391-140
----------	-------------



JANSEN
Dressing Nasal Forceps, bayonet shape, 190mm, 7¹/₂"

Serrated	410-395-190
1x2 teeth	410-396-190

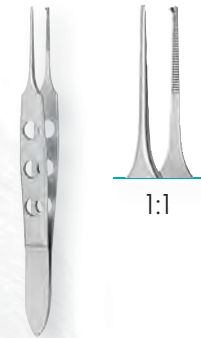

BISHOP-HARMON
Tissue Forceps, straight, 0.5mm tip, 85mm, 3¹/₃"

1x2 teeth	400-118-005
-----------	-------------



GRAEFE
Delicate Tissue Forceps, 1x2 teeth, 100mm, 4"

Straight	130-503-100
Slightly curved	130-504-100
Strongly curved	130-505-100

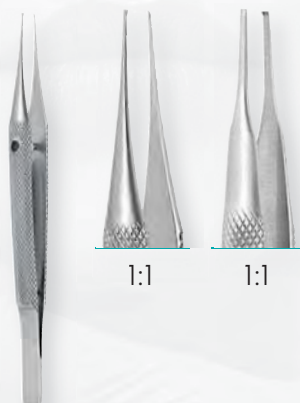

KIRBY
Fixation Forceps, straight, 100mm, 4"

1x2 teeth	400-082-100
2x3 teeth	400-083-100

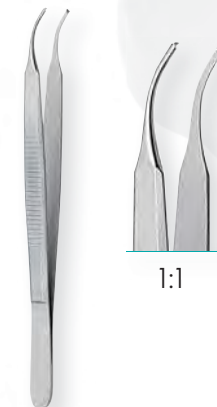

STEVENS
Tissue Forceps, 1 x 2 teeth, 110mm, 4¹/₃"

Slightly curved	130-513-110
-----------------	-------------

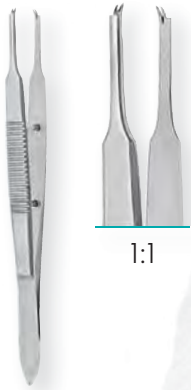

1:1

CASTROVIEJO

Fixation Forceps, straight, 0.3mm tip, 100mm, 4"

2x2 teeth

400-022-090

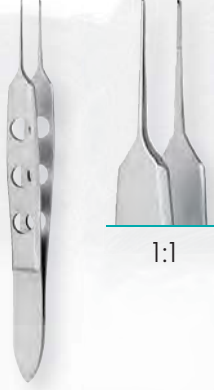

1:1

CASTROVIEJO (HOLE HANDLE)

Suture Forceps, 0.9mm tip, 110mm, 4^{1/3}", tying platform

1x2 teeth

400-137-150



1:1

(0.12mm tip illustrated)

CASTROVIEJO (HOLE HANDLE)

Suture Forceps, 1x2 teeth, 110mm, 4^{1/3}", tying platform

0.12mm tip

400-137-012

0.3mm tip

400-137-030

0.5mm tip

400-137-050



1:1
(0.5mm tip illustrated)

US HANDLE

CASTROVIEJO

Suture Forceps, 1x2 teeth, 110mm, 4^{1/3}", tying platform

0.12mm tip

400-137-021

0.3mm tip

400-137-031

0.5mm tip

400-137-055

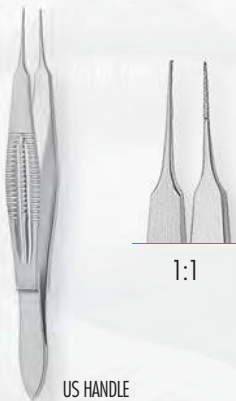

1:1

US HANDLE

CASTROVIEJO (DIAMOND DUSTED)

Suture Forceps, 1x2 teeth, 0.3mm tip, tying platform

100mm, 4"

400-137-003

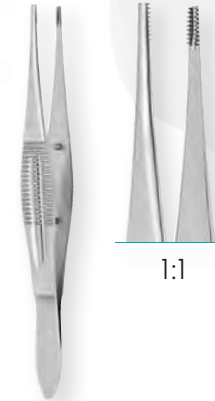

1:1

CASTROVIEJO BROWN

Tissue Forceps, straight, 100mm, 4"

7x7 teeth

400-139-050



1:1

ADSON

Forceps, 1x2 teeth

120mm, 4^{3/4}"

130-140-120

150mm, 6"

130-140-150



1:1

MICRO-ADSON

Forceps, 1x2 teeth

120mm, 4^{3/4}"

130-550-120

150mm, 6"

130-550-150



1:1



Detail

ADSON-DEBAKEY

Atraumatic Forceps, 120mm, 4^{3/4}"

Straight

130-527-120



1:1

GERALD

Tissue Forceps, 1x2 teeth, 180mm, 6^{3/4}"

Curved

130-151-180



1:1

BROWN

Tissue Forceps, 7x7 teeth

160mm, 6^{1/4}"

130-554-160

200mm, 8"

130-554-200



1:1

DEBAKEY

Atraumatic Forceps, 2.0 mm wide, 160mm, 6^{1/4}"

Straight

290-552-160



MILLARD
Hook Forceps, with swivelling ring, 150mm, 6"

1x2 teeth

260-411-150



MILLARD
Hook Forceps, with fixed ring, 150mm, 6"

9x9 teeth

260-412-150

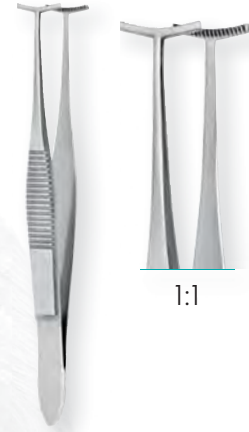

GREEN
Fixation Forceps, 12mm jaws, 110mm, 4¹/₃"

Delicate teeth

400-029-012

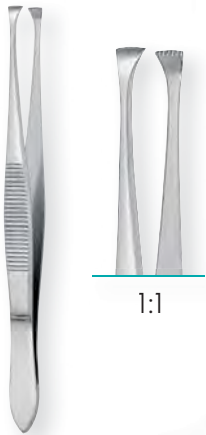

GRAEFE
Fixation Forceps, 4.5mm wide, 110mm, 4¹/₃"

7x8 teeth

400-025-110



KIRBY-BARRAQUER
Fixation Forceps, 110mm, 4¹/₃"

Delicate teeth

400-084-100



BEASLEY-BABCOCK
Tissue Forceps, 6x7 teeth, 125mm, 5"

Straight

130-561-125



FORCEPS

Dressing Forceps
with TC-inserts



1:1

ADSON
TC Dissecting Forceps

120mm, 4^{3/4}"

130-532-120

150mm, 6"

130-532-150



1:1

MICRO-ADSON
TC Dressing Forceps

120mm, 4^{3/4}"

130-538-120

150mm, 6"

130-538-150



1:1

STANDARD
TC Dressing Forceps

145mm, 5^{3/4}"

130-518-145

160mm, 6^{1/4}"

130-518-160

180mm, 7"

130-518-180



1:1

SEMKEN
TC Dressing Forceps

150mm, 6"

130-512-150



1:1

CUSHING
TC Dressing Forceps

180mm, 7"

130-536-175



1:1

POTTS-SMITH
TC Dressing Forceps

150mm, 5^{3/4}"

130-542-150

180mm, 6^{1/4}"

130-542-180

210mm, 7"

130-542-210





MCINDOE
TC Dressing Forceps

150mm, 6"

130-522-150



TICKNER
TC Dressing Forceps, square tip

150mm, 6"

130-536-150



GERALD
TC Dressing Forceps, 170mm, 6²/₃"

170mm, 6³/₄"

130-516-170



CUSHING-TAYLOR
TC Dressing Forceps, bayonet shaped, dissector end

180mm, 7"

130-541-180



DEBAKEY
TC Atraumatic Forceps

1.5mm wide

2.0mm wide

2.7mm wide

160mm, 6¹/₄"

130-568-150

130-570-160

130-572-160

200mm, 8"

130-568-190

130-570-200

130-572-200

240mm, 9¹/₂"

130-568-240

130-570-240

130-572-240

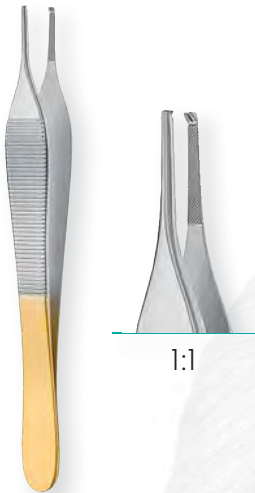

1:1

ADSON

TC Tissue Forceps, 1x2 teeth, with platform

120mm, 4³/₄"

130-534-120

150mm, 6"

130-534-150

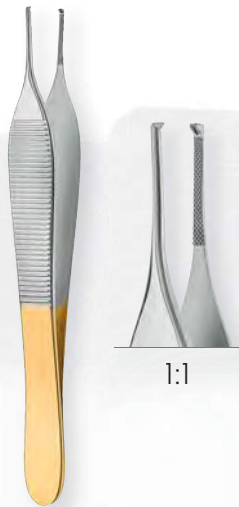

1:1

MICRO-ADSON

TC Tissue Forceps, 1x2 teeth, with platform

120mm, 4³/₄"

130-537-120

150mm, 6"

130-537-150



1:1

ADSON-BROWN

TC Tissue Forceps, 7x7 teeth

120mm, 4³/₄"

130-529-120

150mm, 6"

130-529-150



1:1

SEMKEN

TC Tissue Forceps, 1x2 teeth, with platform

150mm, 6"

130-524-150

180mm, 7"

130-524-180



1:1

GERALD

TC Tissue Forceps, 1x2 teeth, serrated, with platform

180mm, 7"

130-518-170



1:1

GILLIES

TC Tissue Forceps, 1x2 teeth, with platform

150mm, 6"

130-520-150



1:1

OEHLER

TC Tissue Forceps, 1x2 teeth, with platform

145mm, 5 ³ / ₄ "	130-522-145
160mm, 6 ¹ / ₄ "	130-522-160
180mm, 7"	130-522-180

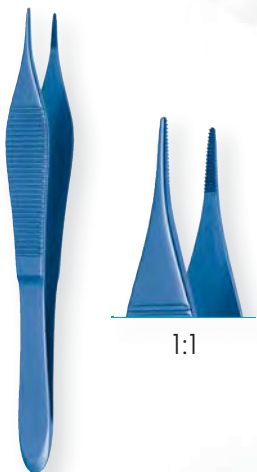

1:1

TITAN ADSON

Dressing Forceps

120mm, 4 ³ / ₄ "	130-242-120
150mm, 6"	130-242-150



1:1

TITAN ADSON-BROWN

Tissue Forceps, 7x7 teeth

120mm, 4 ³ / ₄ "	130-243-120
150mm, 6"	130-243-150



1:1

TITAN GILLIES

Tissue Forceps, 1x2 teeth

150mm, 6"	130-239-150
-----------	-------------



MONOPOLAR FORCEPS





GILLIES

Tissue Forceps, 1x2 teeth, 150mm

Without plug	130-720-150
4mm male plug	130-719-150



GERALD

Tissue Forceps, 1x2 teeth

	180mm, 7"	230mm, 8"
Without plug	130-750-180	130-750-230
4mm male plug	130-749-180	130-749-230



ADSON

Tissue Forceps, 1x2 teeth, 2mm tip, 120mm

Without plug	130-740-120
4mm male plug	130-746-120



MICRO-ADSON

Tissue Forceps, 1x2 teeth, 150mm

Without plug	130-750-150
4mm male plug	130-751-150

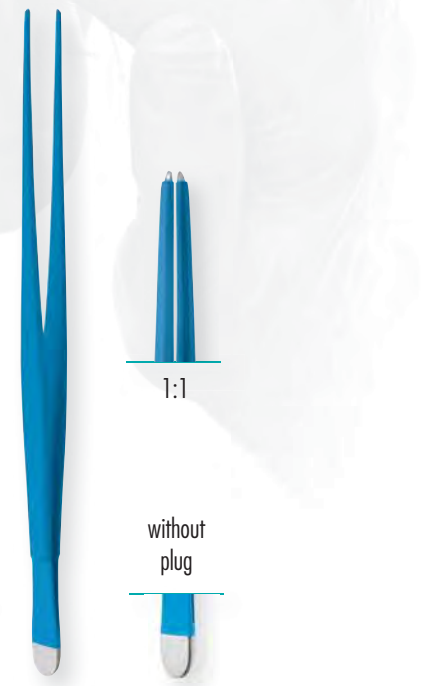

SULIVAN

Forceps, very delicate, smooth jaws, 1mm tips, 250mm

Without plug	130-743-250
--------------	-------------

For suitable monopolar cables see page 76.



MONOPOLAR FORCEPS

Monopolar
Forceps



1:1



Without plug



Male 4mm plug

180mm, 7"	130-738-180	130-752-180
210mm, 8 ¹ / ₄ "	130-738-210	130-752-210
250mm, 10"	130-738-250	130-752-250
300mm, 12"	130-738-300	130-752-300

POTTS-SMITH

Dressing Forceps, serrated, elevated shanks



1:1



Without plug



Male 4mm plug

180mm, 7"	130-741-180	130-748-180
210mm, 8 ¹ / ₄ "	130-741-210	130-748-210
250mm, 10"	130-741-250	130-748-250
300mm, 12"	130-741-300	130-748-300

POTTS-SMITH

Tissue Forceps, 1x2 teeth, elevated shanks



1:1



Without plug



Male 4mm plug

145mm, 5 ³ / ₄ "	130-740-145	130-747-145
180mm, 7"	130-740-180	130-747-180
210mm, 8 ¹ / ₄ "	130-740-210	130-747-210
250mm, 10"	130-740-250	130-747-250
300mm, 12"	130-740-300	130-747-300

POTTS-SMITH

Dressing Forceps, serrated



1:1



Without plug



Male 4mm plug

145mm, 5 ³ / ₄ "	130-753-145	130-754-145
180mm, 7"	130-753-180	130-754-180
210mm, 8 ¹ / ₄ "	130-753-210	130-754-210
250mm, 10"	130-753-250	130-754-250
300mm, 12"	130-753-300	130-754-250

POTTS-SMITH

Tissue Forceps, 1x2 teeth

For suitable monopolar cables see page 76.



RZ
Medizintechnik
GmbH



1:1

without
plug



protected male
4mm plug



CUSHING

Dressing Forceps, serrated

175mm, 7"

200mm, 8"

Without plug

130-736-175

130-736-200

4mm male plug

130-737-175

130-737-200



1:1

without
plug



DEBAKEY

Atraumatic Forceps, 1.5mm tip

160mm, 6¹/₄"

200mm, 8"

240mm, 9¹/₂"

300mm, 12"

1.5mm tip

290-850-160

290-850-200

290-850-240

290-850-300

2.0mm tip

290-851-160

290-851-200

290-851-240

290-851-300

2.4mm tip

290-852-160

290-852-200

290-852-240

290-852-300

2.7mm tip

290-853-160

290-853-200

290-853-240

290-853-300

3.5mm tip

290-854-160

290-854-200

290-854-240

290-854-300

For suitable monopolar cables see page 76.



BIPOLAR NON-STICK FORCEPS





NON-STICK
Bipolar Forceps, straight

Tip width	Total length	Flat plug	2-pin plug
0.3mm	150mm, 6"	700-010-150	700-012-150
	180mm, 7"	700-010-180	700-012-180
	200mm, 8"	700-010-200	700-012-200
	225mm, 9"	700-010-220	700-012-220
0.6mm	150mm, 6"	700-020-150	700-022-150
	180mm, 7"	700-020-180	700-022-180
	200mm, 8"	700-020-200	700-022-200
	225mm, 9"	700-020-220	700-022-220
1.0mm	150mm, 6"	700-030-150	700-032-150
	180mm, 7"	700-030-180	700-032-180
	200mm, 8"	700-030-200	700-032-200
	225mm, 9"	700-030-220	700-032-220
2.0mm	150mm, 6"	700-040-150	700-042-150
	180mm, 7"	700-040-180	700-042-180
	200mm, 8"	700-040-200	700-042-200
	225mm, 9"	700-040-220	700-042-220



NON-STICK
Bipolar Forceps, angled

Tip width	Total length	Flat plug	2-pin plug
0.3mm	150mm, 6"	700-011-150	700-013-150
	180mm, 7"	700-011-180	700-013-180
	200mm, 8"	700-011-200	700-013-200
	225mm, 9"	700-011-220	700-013-220
0.6mm	150mm, 6"	700-021-150	700-023-150
	180mm, 7"	700-021-180	700-023-180
	200mm, 8"	700-021-200	700-023-200
	225mm, 9"	700-021-220	700-023-220
1.0mm	150mm, 6"	700-031-150	700-033-150
	180mm, 7"	700-031-180	700-033-180
	200mm, 8"	700-031-200	700-033-200
	225mm, 9"	700-031-220	700-033-220
2.0mm	150mm, 6"	700-041-150	700-043-150
	180mm, 7"	700-041-180	700-043-180
	200mm, 8"	700-041-200	700-043-200
	225mm, 9"	700-041-220	700-043-220



NON-STICK FORCEPS

Bipolar
Non-Stick Forceps



1:1

flat plug

2-pin plug

Tip width	Total length	Flat plug	2-pin plug
0.3mm	150mm, 6"	700-050-150	700-052-150
	180mm, 7"	700-050-180	700-052-180
	200mm, 8"	700-050-200	700-052-200
	225mm, 9"	700-050-220	700-052-220
0.6mm	150mm, 6"	700-060-150	700-062-150
	180mm, 7"	700-060-180	700-062-180
	200mm, 8"	700-060-200	700-062-200
	225mm, 9"	700-060-220	700-062-220
1.0mm	150mm, 6"	700-070-150	700-072-150
	180mm, 7"	700-070-180	700-072-180
	200mm, 8"	700-070-200	700-072-200
	225mm, 9"	700-070-220	700-072-220
2.0mm	150mm, 6"	700-080-150	700-082-150
	180mm, 7"	700-080-180	700-082-180
	200mm, 8"	700-080-200	700-082-200
	225mm, 9"	700-080-220	700-082-220

NON-STICK

Bipolar Forceps, bayonet



For suitable monopolar cables see page 76.

MONOPOLAR CABLES

Generator end									
			4mm socket	4mm socket, ang.	2mm plug	4mm plug	3mm socket	4mm hexagon	4mm plug
	3 m	700-501-303							
	5 m	700-501-503							
	3 m	700-501-302							
	5 m	700-501-502							
	3 m	700-280-030	700-290-030	700-291-030			700-292-030	700-293-030	700-293-033
	5 m	700-280-050	700-290-050	700-291-050					700-293-035
	3 m	700-360-031	700-361-030	700-362-030	700-363-030	700-364-030			700-370-030
	5 m	700-360-051	700-361-050	700-362-050	700-363-050				700-370-050
	3 m	700-285-030		700-286-030	700-286-130				700-286-230
	5 m	700-285-050		700-286-050					
	3 m	700-101-030	700-102-030	700-103-030				700-105-030	
	5 m	700-101-050		700-103-050			700-104-050		

BIPOLAR CABLES

Generator end								
			Flat Plug	Flat plug, angled	Flat plug, square	2-pin plug	2-pin plug, angled	2-pin plug, angled
	3 m	700-350-030	300-860-100	700-350-130	700-351-030	700-345-403	700-345-003	
	5 m	700-350-050	300-860-111	700-350-150	700-351-050	700-345-405	700-345-005	
	3 m	700-101-001	700-100-130	700-101-130	700-100-102	700-101-230		
	5 m	700-100-101	700-100-150	700-101-150	700-100-103	700-101-250		
	3 m	700-287-030	700-200-130	700-287-130	700-200-132	700-287-230		
	5 m	700-287-050	700-200-150	700-287-150	700-200-152	700-287-250		
	3 m	700-351-031	700-300-003	700-351-131	700-300-203	700-351-231	700-300-403	
	5 m	700-351-051	700-300-005	700-351-151	700-300-205	700-351-251	700-300-405	
	3 m	700-400-050	700-400-003	700-400-103	700-400-203	700-400-303	700-400-403	
	5 m	700-400-055		700-400-105				
	3 m	700-400-035			700-400-230			
	5 m	700-400-036			700-400-250			
	3 m	700-400-041			700-400-330	700-400-430	700-400-530	
	5 m	700-400-040			700-400-350	700-400-450	700-400-550	
	3 m	700-400-030		700-400-130				
	5 m							

* Not for sale within Europe



FORCEPS & CLAMPS





JACOBSON

Hemostatic Forceps, 0.3mm tips

	Straight	Curved	Strongly curved
100mm, 4"	140-160-100	140-161-100	–
130mm, 5 ¹ / ₈ "	140-160-130	140-161-130	–
190mm, 7 ¹ / ₂ "	140-160-190	140-161-190	140-162-190
230mm, 9"	140-160-230	140-161-230	–

MICRO-MOSQUITO

Hemostatic Forceps, 120mm, 4³/₄"

Straight	140-270-120
Curved	140-271-120

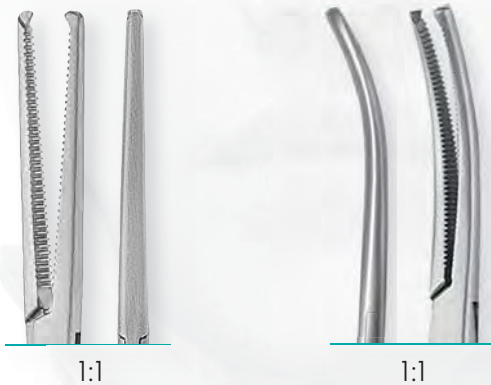

KOCHER (DELICATE)

Hemostatic Forceps, 1x2 teeth

	Straight	Curved
130mm, 5 ¹ / ₈ "	140-318-130	140-319-130
140mm, 5 ¹ / ₂ "	140-318-140	140-319-140
160mm, 6 ¹ / ₄ "	140-318-160	140-319-160

MICRO-ADSON

Dissecting Forceps, 140mm, 5¹/₂"

Curved	140-338-140



FORCEPS & CLAMPS

Hemostatic & Tissue
Forceps, Bulldog Clamps



1:1

HARTMANN

Titanium Hemostatic Forceps, 90mm, 3 1/2"

Straight	140-258-090
Curved	140-259-090



1:1

HALSTEAD-MOSQUITO

Titanium Hemostatic Forceps, 125mm, 5"

Straight	140-258-125
Curved	140-259-125



1:1

MICRO HALSTEAD-MOSQUITO

Titanium Hemostatic Forceps, 125mm, 5"

Straight	140-262-125
Curved	140-263-125

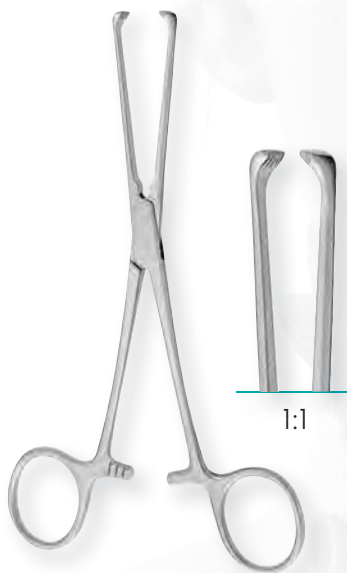

1:1

ALLIS

Tissue Forceps, 5x6 teeth

150mm, 6"	310-014-150
190mm, 7 1/2"	310-014-190



1:1

ALLIS

TC Atraumatic Tissue Grasping Forceps

140mm, 5 2/3"	310-022-140
---------------	-------------



JOHNS-HOPKINS

Bulldog Clamp, 38mm, 1 1/2"

Straight	140-050-038
Curved	140-051-038



DIETRICH-DEBAKEY

Micro Bulldog Clamp, angled, 3g weight

45mm, 14mm jaws	140-221-425
50mm, 20mm jaws	140-221-426

More bulldog clamps in our RZ Bulldog Clamps brochure.



1:1

D'ASSUMPCAO

Face Lift Forceps, without ratchet

160mm, 6 ¹ / ₄ "	260-520-010
260mm, 10 ¹ / ₄ "	260-520-016

For precise marking of dissected facial flaps for excision.



1:1

D'ASSUMPCAO

Face Lift Forceps, with ratchet

160mm, 6 ¹ / ₄ "	260-520-020
260mm, 10 ¹ / ₄ "	260-520-026

For precise marking of dissected facial flaps for excision.



1:1

LOCKWOOD

Abdominal Demarcator

310mm, 6 ¹ / ₄ "	260-268-310
320mm, 10 ¹ / ₄ "	260-268-410

For the measuring of abdominal flaps.

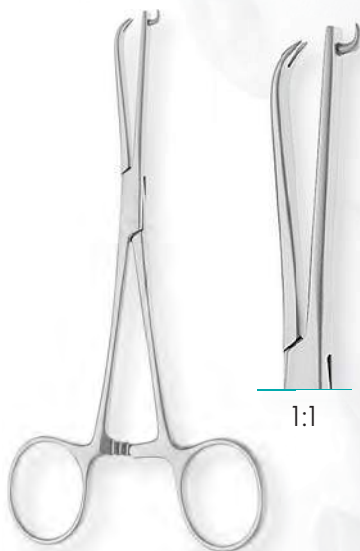

1:1

MARTEN

Flap Forceps, 145mm, 5³/₄"

Without ratchet	260-233-145
With ratchet	260-234-145

For accurate marking of skin flaps.



1:1

PITANGUY

Flap Demarcator

150mm, 6"	260-267-155
260mm, 10 ¹ / ₄ "	260-267-260

For accurate marking of facial or abdominal flaps that are to be excised.

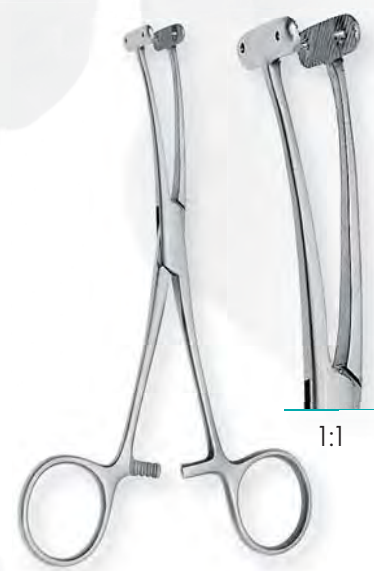

1:1

MARTEL

Flap Grasping Forceps

140mm, 5 ¹ / ₂ "	140-267-140
--	-------------



NEEDLE HOLDERS



Depending on their application, our TCs are equipped with the most suitable TC-inserts.

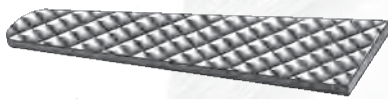

R - Regular 0.5mm

For use with sutures up to size 4-0

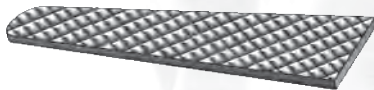

F - Fine 0.4mm

For delicate needles and sutures up to sizes 5-0 and 6-0

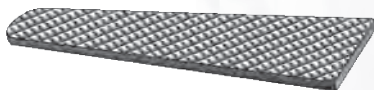

EF - Extra-Fine 0.3mm

For use with micro-needles and sutures up to size 10-0



S - Smooth

For delicate needles and sutures from sizes 7-0 to 10-0



D - Diamond dusted

For very delicate needles and suture material

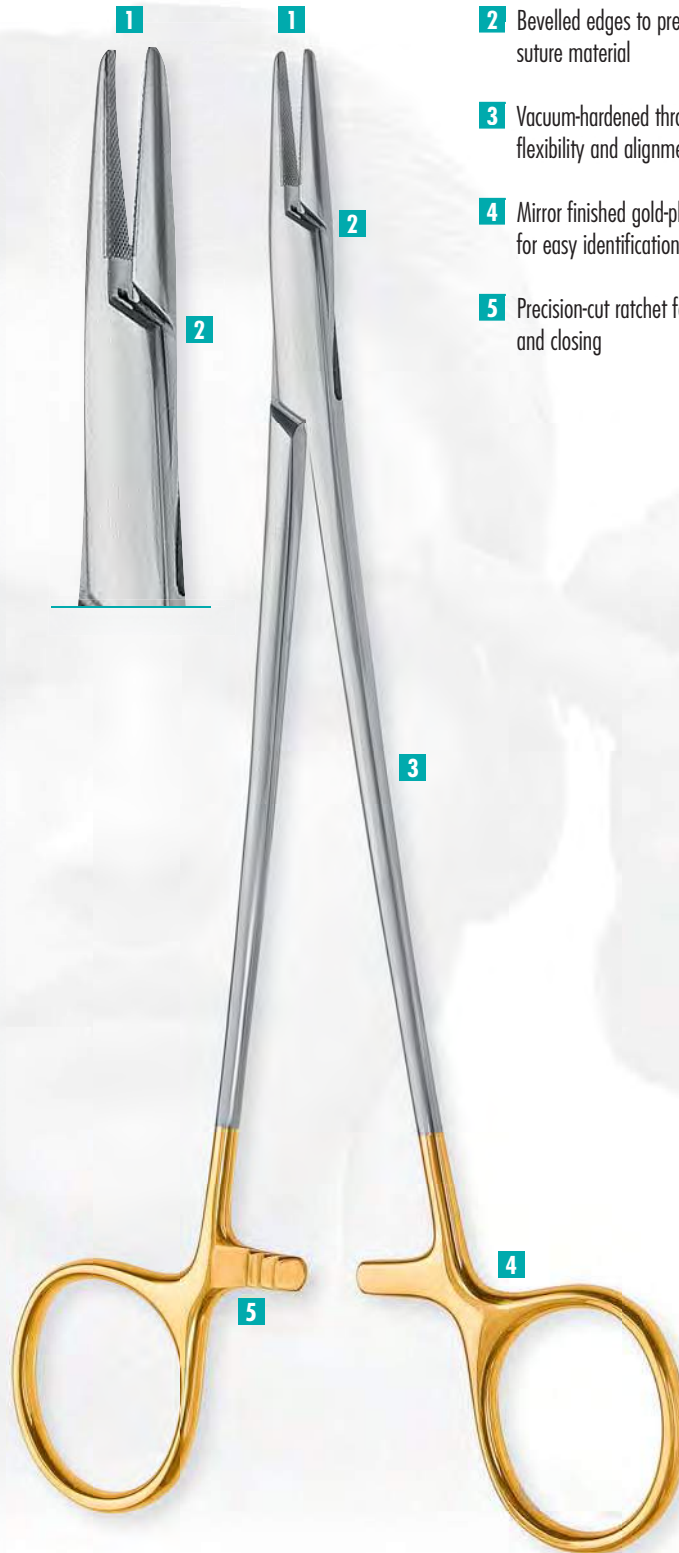

- 1** Milled inserts of solid tungsten carbide for long-lasting secure grip of suture needles
- 2** Bevelled edges to prevent catching of suture material
- 3** Vacuum-hardened throughout for consistent flexibility and alignment
- 4** Mirror finished gold-plated ring handles for easy identification
- 5** Precision-cut ratchet for safe opening and closing



NEEDLE HOLDERS

Standard Needle Holder,
TC Needle Holder



PAR
TC Needle Holder, very delicate, serrated

115mm, 4 ³ / ₄ "	180-555-115
120mm, 4 ³ / ₄ "	180-558-120
135mm, 4 ³ / ₄ "	180-558-135



DERF
TC Needle Holder, serrated

120mm, 4 ³ / ₄ "	180-532-120
--	-------------



CONVERSE
TC Needle Holder, serrated

120mm, 4 ³ / ₄ "	180-544-120
--	-------------

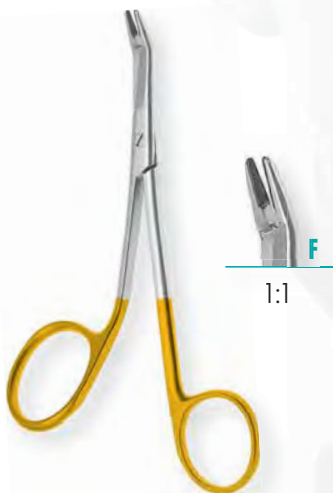

FOSTER-GILLIES
TC Needle Holder

120mm, 4 ³ / ₄ "	180-570-120
--	-------------

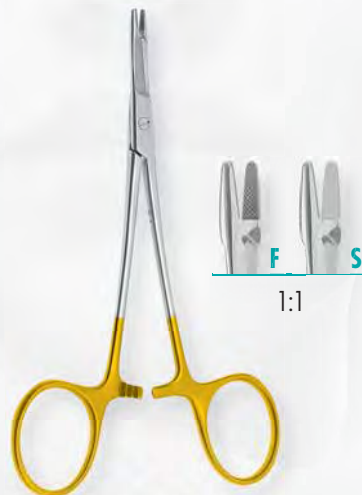

MINI OLSEN-HEGAR
TC Needle Holder, 120mm, 4³/₄"

Fine	180-568-120
Smooth	180-569-120



HALSEY
TC Needle Holder, 130mm, 5"

Smooth	180-536-130
Fine	180-537-130





WEBSTER
TC Needle Holder, slim jaw, 130mm, 5"

Smooth	180-538-130
Fine	180-539-130



WEBSTER
TC Needle Holder, smooth jaws

130mm, 5"	180-570-130
-----------	-------------

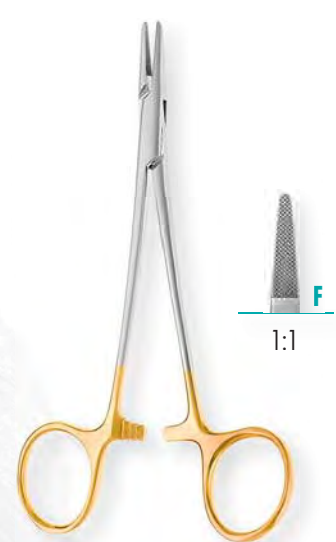

NEIVERT
TC Needle Holder

130mm, 5 ¹ / ₈ "	180-533-130
--	-------------

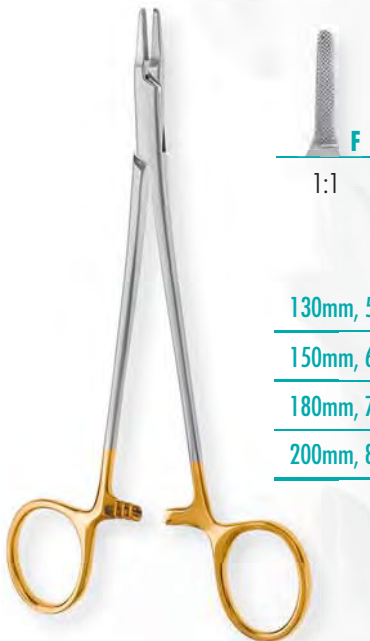

RYDER
TC Vascular Needle Holder, 2mm jaw

130mm, 5 ¹ / ₈ "	180-560-130
150mm, 6"	180-560-160
180mm, 7"	180-560-180
200mm, 8"	180-560-200

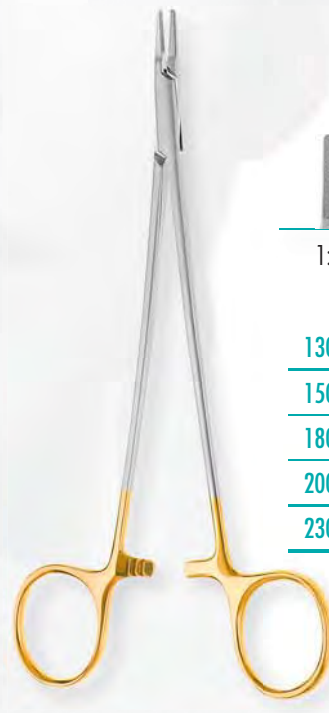

RYDER-VASCULAR
TC Needle Holder, 1.5mm jaw

130mm, 5 ¹ / ₈ "	180-561-130
150mm, 6"	180-561-150
180mm, 7"	180-561-180
200mm, 8"	180-561-200
230mm, 9"	180-561-230



125mm, 5"	180-550-125
140mm, 5 ¹ / ₂ "	180-550-140
160mm, 6 ¹ / ₄ "	180-550-160
180mm, 7"	180-550-180
200mm, 7 ⁷ / ₈ "	180-550-200
240mm, 9 ¹ / ₂ "	180-550-240
260mm, 10 ¹ / ₄ "	180-550-260
300mm, 12"	180-550-300
400mm, 16"	180-550-400

MAYO-HEGAR
TC Needle Holder, straight, serrated



140mm, 5 ¹ / ₂ "	180-568-140
170mm, 6 ² / ₃ "	180-568-170
190mm, 7 ¹ / ₂ "	180-568-180

OLSEN-HEGAR
TC Vascular Needle Holder, serrated



150mm, 6"	180-540-150
180mm, 7"	180-540-180
200mm, 8"	180-540-200
230mm, 9"	180-540-230
260mm, 10 ¹ / ₄ "	180-540-260

CRILE-WOOD
TC Needle Holder, straight, serrated

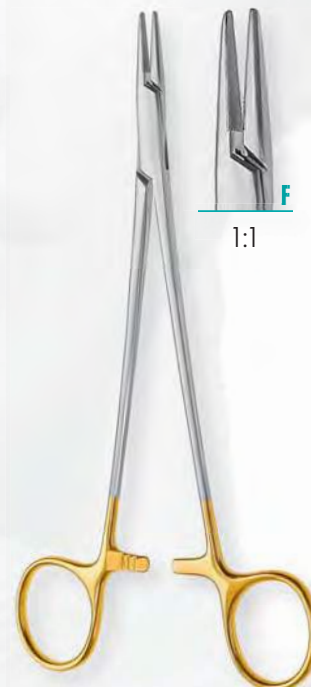

Straight	
150mm, 6"	180-548-150
180mm, 7"	180-548-180
200mm, 8"	180-548-200
230mm, 9"	180-548-230
Curved	
150mm, 6"	180-549-150
180mm, 7"	180-549-180
200mm, 8"	180-549-200
230mm, 9"	180-549-230

DEBAKEY
TC Needle Holder, serrated

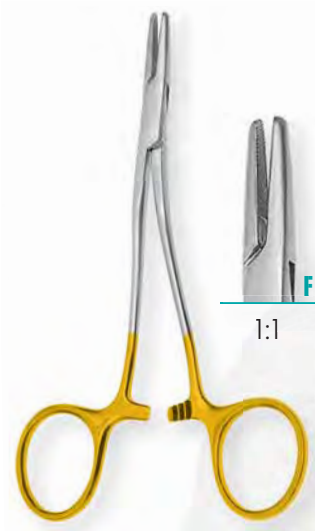

KILNER
TC Needle Holder, s-curved, serrated

135mm, 5¹/₃" 180-525-135



HEGAR-BAUMGARTNER
TC Needle Holder, serrated

140mm, 5¹/₂" 180-534-140



BABY CRILE-WOOD
TC Needle Holder, serrated

150mm, 6" 180-542-150

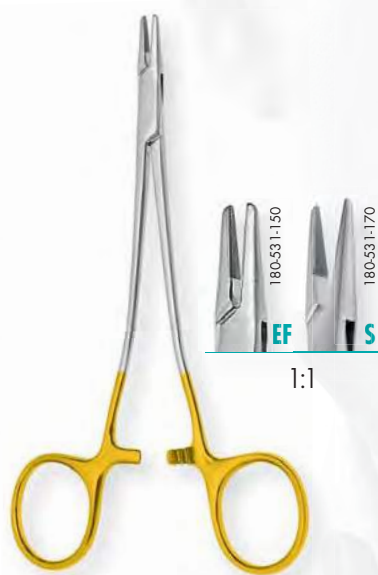

SENNING
TC Needle Holder, serrated

150mm, 6" 180-531-150
170mm, 6²/₃" 180-531-170



MINI-GILLIES
TC Needle Holder, curved, serrated

150mm, 6" 180-588-150



GILLIES
TC Needle Holder, curved, serrated

160mm, 6¹/₄" 180-570-160



NEEDLE HOLDERS

TC Needle Holders



TC Wire Holding Forceps, square jaws, serrated

160mm, 6¹/₄"

180-571-150



TC Wire Holding Forceps, round jaws, serrated

130mm, 5¹/₈"

180-569-130

180mm, 7"

180-569-180



OLSEN-HEGAR

TC Needle Holder, serrated

170mm, 6³/₄"

180-567-170

190mm, 7¹/₂"

180-567-190

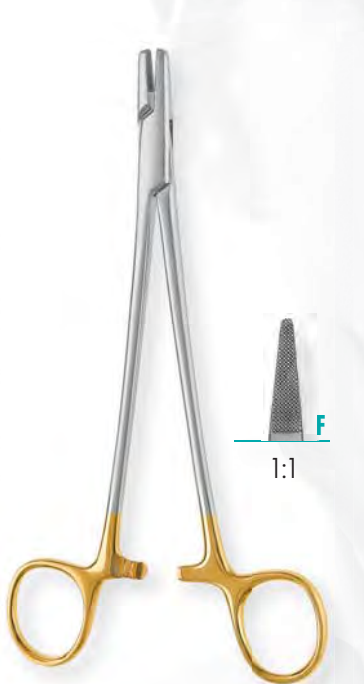

SAROT

TC Needle Holder, serrated

180mm, 7"

180-545-180

200mm, 8"

180-545-200

260mm, 10¹/₄"

180-545-260

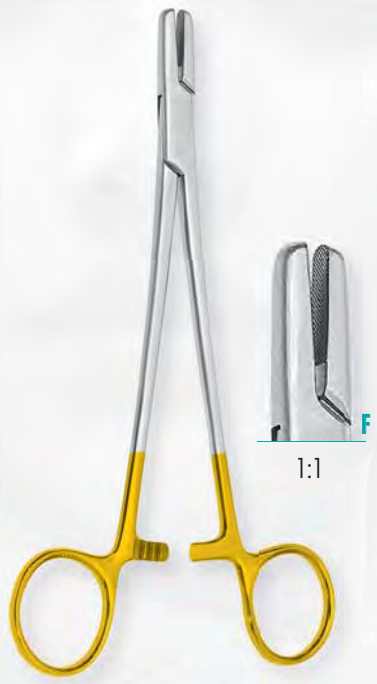

BERRY

TC Wire Holding Forceps, round jaws, serrated

200mm, 8"

180-570-200





SENNING
Needle Holder, slim pattern

170mm, 6³/₄"

180-335-170



DEBAKEY
Needle Holder, diamond dusted, 1mm tip

180mm, 7"

180-648-180



LOEFFLER
Needle Holder, delicate short jaws, diamond dusted

150mm, 6"

180-755-150

Suitable for suturing in rhinoplastic surgery.



NEEDLE HOLDERS

Titanium
Needle Holders



RYDER
TC Titanium Needle Holder, delicate tips

150mm, 6"	180-661-150
180mm, 7"	180-661-180
190mm, 7 1/2"	180-661-190



RYDER
Titanium Needle Holder, diamond dusted, 2mm tip

180mm, 7"	180-660-180
-----------	-------------



HALSEY
Titanium Needle Holder, diamond dusted

125mm, 5"	180-670-125
-----------	-------------



DERF
Titanium Needle Holder, diamond dusted

125mm, 5"	180-671-115
-----------	-------------



Titanium Vascular Needle Holder
delicate, diamond dusted

160mm, 6 1/4"	180-674-160
---------------	-------------

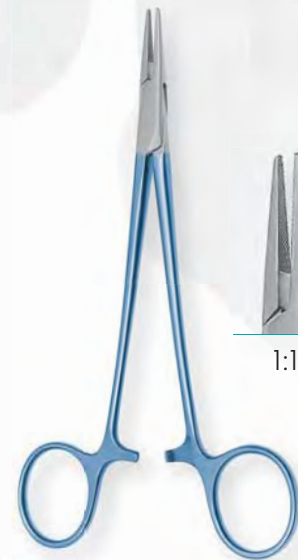

DEBAKEY
Titanium Needle Holder, diamond dusted

160mm, 6 1/4"	180-675-160
---------------	-------------





BARRAQUER

Micro Needle Holder, curved, smooth, delicate, with ratchet, Ø8mm round handle

135mm, 5¹/₃"

400-350-135



BARRAQUER

Micro Needle Holder, curved, smooth, without ratchet, Ø8mm round handle

130mm, 5¹/₈"

400-348-135



BARRAQUER

TC Micro Needle Holder, serrated, with ratchet, Ø8mm round handle, 140mm, 5¹/₂"

Straight

180-512-145

Curved

180-513-145



CASTROVIEJO

TC Micro Needle Holder, serrated, with ratchet, sand-blasted, flat handle, 140mm, 5¹/₂"

Straight

180-520-145

Curved

180-522-145



JACOBSON

Micro Needle Holder, diamond dusted, with ratchet, Ø8mm round handle, 180mm, 7"

Straight

250-264-246

Curved

250-264-247



Micro Needle Holder Forceps, balanced, curved, with tying platform, round handle, 0.6 mm tip

150mm, 6"

251-660-150

More Micro Needle Holders illustrated in our Micro Vascular and Micro Neuro Catalogue.



WOUND RETRACTORS





PENN (HUMBY)
Double Skin Hook, sharp

115mm, 4¹/₂"

170-021-115



GRAEFTE
Skin Hook, 120mm, 4³/₄"

Sharp

170-010-125

Blunt

170-011-125



O'CONNOR
Skin Hook, sharp

120mm, 4³/₄"

170-040-160



CUSHING
Skin Hook, sharp

140mm, 5¹/₂"

170-015-140



KILNER
Skin Hook, sharp, detachable tip

155mm, 6¹/₈"

230-203-002

tip only

230-203-102



KILNER
Skin Hook, sharp

150mm, 6"

230-203-150



1:1

BARSKY

Double Skin Hook, sharp, 150mm, 6"

Non-detachable	170-019-000
Detachable	170-020-000
Tip only	170-020-100

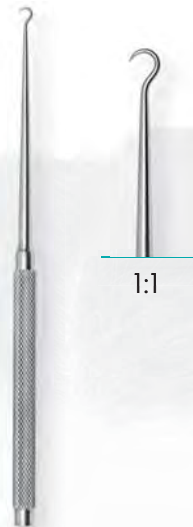

1:1

KLEINERT-KUTZ

Skin Hook, sharp, 160mm, 6¹/₂"

3mm	170-020-001
5mm	170-020-002
8mm	170-020-003



1:1

CLOWARD

Skin Hook, sharp

165mm, 6 ¹ / ₂ "	170-014-165
--	-------------

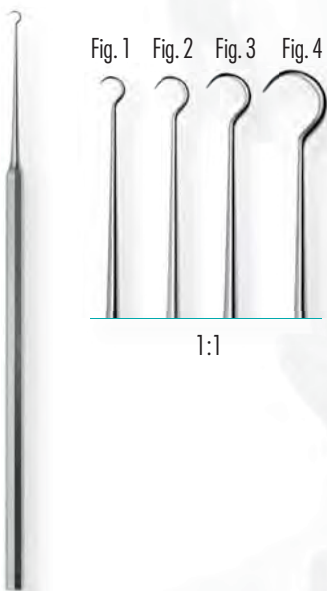

Fig. 1 Fig. 2 Fig. 3 Fig. 4

1:1

NIRO

Skin Hook, sharp, 170mm, 6³/₄"

Fig. 1	170-041-001
Fig. 2	170-041-002
Fig. 3	170-041-003
Fig. 4	170-041-004



1:1

GILLIES

Skin Hook, sharp, square handle

175mm, 7"	170-237-175
-----------	-------------

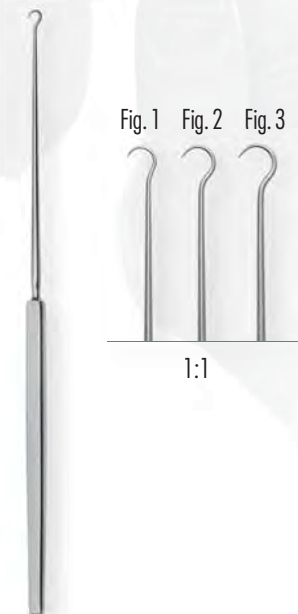

Fig. 1 Fig. 2 Fig. 3

1:1

GILLIES

Skin Hook, sharp, 180mm, 7"

Fig. 1	230-205-180
Fig. 2	230-207-180
Fig. 3	230-209-180



1:1

GUTHRIE

Fine Wound Retractor, 2 prongs, sharp

120mm, 4 ³ / ₄ "	170-042-130
130mm, 5 ¹ / ₈ "	170-044-130

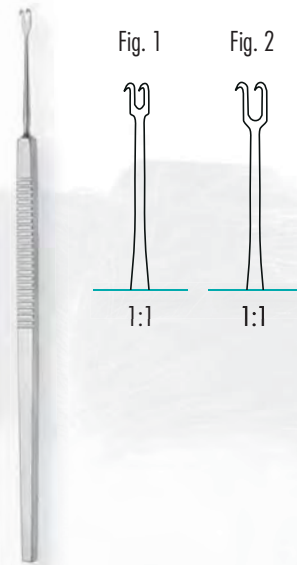

Fig. 1

Fig. 2

1:1

1:1

GUTHRIE

Fine Wound Retractor, 2 prongs, sharp, 160mm, 6¹/₄"

Fig. 1	170-042-160
Fig. 2	170-044-160



1:1

RZ-SQUARE

Fine Wound Retractor, 2 prongs, 175mm, 7"

Blunt	170-122-175
Sharp	170-123-175

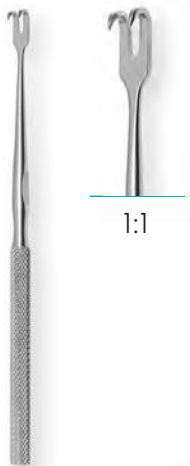

1:1

LAHEY

Fine Wound Retractor, sharp, 120mm, 4³/₄"

1 prong	170-031-120
2 prongs	170-033-120
3 prongs	170-034-120



1:1

KNAPP

Fine Wound Retractor, 4 prongs, sharp, 130mm, 5¹/₈"

Sharp	170-080-001
Blunt	170-080-002



1:1

RZ

Fine Wound Retractor, 6 prongs, sharp

135mm, 5 ¹ / ₃ "	170-081-135
--	-------------



WOUND RETRACTORS

Wound Retractors, Alar Retractors

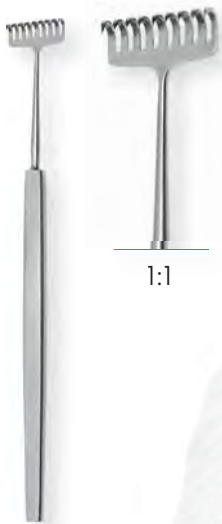

1:1

MILLER

Fine Wound Retractor, 9 prongs, 135mm, 5¹/₃"

Sharp	170-085-130
Blunt	170-086-130



1:1

SCHWALBENSCHWANZ

Wound Retractor, sharp, 180mm, 7"

2 prongs	170-079-002
3 prongs	170-079-003



1:1

Wound Retractor, 5 prongs, sharp,
15mm wide, square handle

175mm, 6 ⁷ / ₈ "	170-879-175
--	-------------

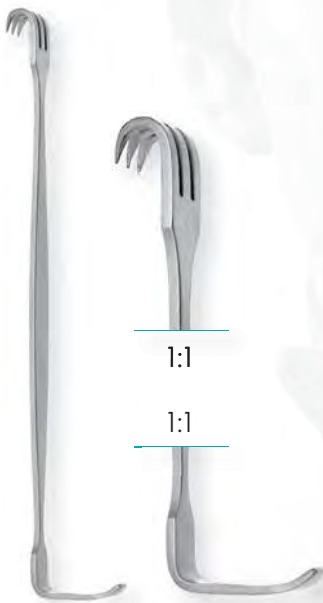

1:1

1:1

BABY SENN-MILLER

Retractor, 3 prongs, 20x7mm blade, 160mm, 6¹/₄"

Blunt	170-213-160
Sharp	170-214-160



1:1

FOMON

Alar Retractor, 2 buttoned prongs

160mm, 6 ¹ / ₄ "	230-280-160
--	-------------



1:1

FOMON

Alar Retractor, insulated, 2 buttoned prongs

160mm, 6 ¹ / ₄ "	230-780-160
--	-------------





1:1

COTTLE

Alar Retractor, 2 prongs, sharp with one buttoned prong, 140mm, 5¹/₂"

Buttoned right 230-281-140

Buttoned left 230-282-140

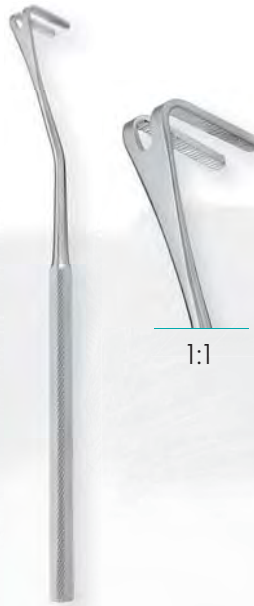

1:1

STACK

Fork Retractor, 15mm deep, square handle

175mm, 6⁷/₈" 230-195-175



1:1

MOBERG

Wound and Skin Retractor, 17x5mm blade

175mm, 6⁷/₈" 170-136-175

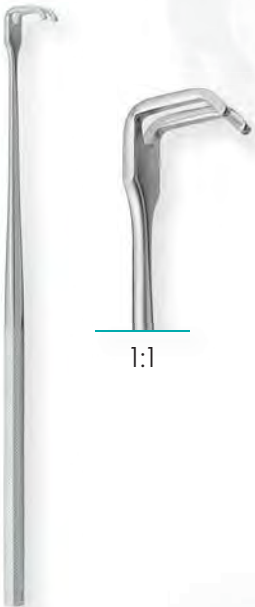

1:1

Retractor, 15mm blade length, 2 prongs, square handle

175mm, 6⁷/₈" 170-275-175

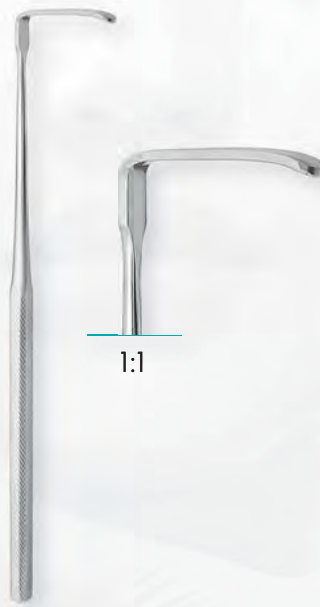

1:1

BUCK-GRAMCKO

Retractor, 25x6mm, square handle

175mm, 6⁷/₈" 170-296-175



1:1

Hook, 1 prong, sharp, 9mm deep, square handle

175mm, 6⁷/₈" 170-079-175



WOUND RETRACTORS

Lid Retractors,
Alar Retractors



RZ

Skin Retractor, fenestrated, square handle, 175mm, 6⁷/₈"

12x14mm	230-140-175
13x16mm	230-160-175
14x19mm	230-190-175

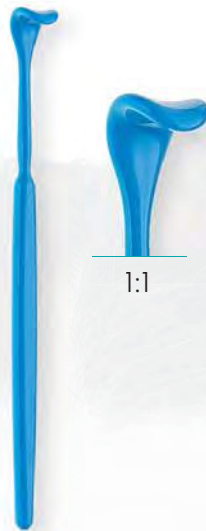

DESMARRES

Lid Retractor, insulated

	Total length	
10mm blade	130mm, 5"	170-510-130
13mm blade	140mm, 5 ¹ / ₂ "	170-513-145
12mm blade	160mm, 6 ¹ / ₄ "	170-512-160
13mm blade	160mm, 6 ¹ / ₄ "	170-513-160

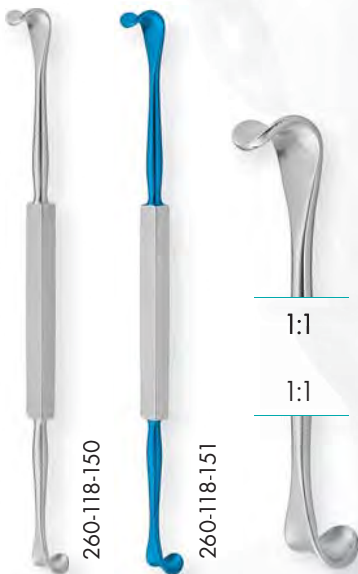

DESMARRES

Lid Retractor, 8mm/10mm, 150mm, 6"

Non-insulated	260-118-150
Insulated	260-118-151



COTTLE

Alar Retractor, 10x12mm, 140mm, 5¹/₂"

Non-insulated	420-523-140
Insulated	420-523-141

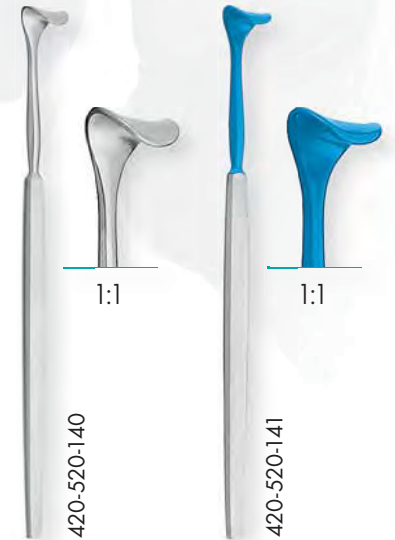

MASING

Alar Retractor, 6x12mm, 140mm, 5¹/₂"

Non-insulated	420-520-140
Insulated	420-520-141





KASDEN

Retractor, 165mm, 6^{1/2}"

Non-insulated

170-130-165

Insulated

171-130-165

COTTLE-NEIVERT

Alar Retractor, 2 blunt prongs, saw/knife guide

200mm, 8"

230-260-200

NEIVERT

Nasal Retractor, double-ended, with knife guide

160mm, 6^{1/4}"

170-036-180



WOUND RETRACTORS

Rake Retractors



FREEMAN
Rake Retractor, 4 prongs, with thumb ring

50mm, 2"

260-012-198



FREEMAN
Rake Retractor, 4 prongs, reversed, thumb ring

50mm, 2"

260-012-398



FREEMAN
Rake Retractor, 4 prongs, 2 recessed, thumb ring

50mm, 2"

260-015-198



GORNEY
Rake Retractor, 4 prongs, sharp, with spring

75mm, 3"

260-020-038



FREEMAN
Rake Retractor, 4 prongs, sharp

100mm, 4"

260-012-192



FREEMAN
Rake Retractor, 4 prongs (2 recessed), sharp

100mm, 4"

260-013-192





WOUND RETRACTORS

Rake Retractors



FREEMAN
Rake Retractor, 4 prongs, sharp, 2 prongs recessed

180mm, 7"

260-012-193



FREEMAN
Rake Retractor, 4 prongs, sharp

180mm, 7"

260-012-195



FREEMAN
Rake Retractor, 4 prongs, sharp, 2 prongs recessed

180mm, 7"

260-012-191



FREEMAN-ADAMSON
Face Lift Retractor, 4 prongs, angled, sharp

180mm, 7"

260-013-191



VAN SICKLE
Rake Retractor, 4 prongs (2 recessed), blunt

180mm, 7"

260-012-194



Rake Retractor, 3 prongs, sharp

115mm, 4 1/2"

260-210-130



WOUND RETRACTORS

Skin/Nasal
Retractors



MILLARD
Thimble Hook

1 prong

260-418-100



MILLARD
Thimble Hook

2 prongs

260-418-120



ANDERSON
Retractor, 3 prongs

120mm, 4³/₄"

260-012-212



ANDERSON
Retractor, 5 prongs

120mm, 4³/₄"

260-012-210



KILNER
Nasal Retractor, 80mm, 3¹/₈"

Sharp/sharp

420-184-100

Blunt/blunt

420-185-100



CONVERSE
Alar Retractor, double-ended, 120mm, 4³/₄"

Blunt

260-501-120

Sharp

260-502-120



RZ-NOSE
RZ Nasal Retractor with Thimble Hook, swivelling

85mm, 3¹/₈"

260-200-110





SISSON
Wire Spring Retractor, 1x1 sharp prongs

105mm, 4 ¹ / ₈ "	260-711-110
--	-------------

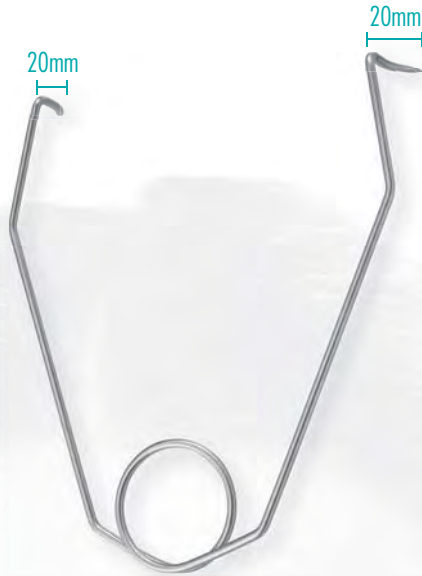

FARR
Retractor Wire, sharp, 20mm

140mm, 5 ¹ / ₂ "	170-711-140
--	-------------



ALM
Self Retaining Retractor, 4x4 teeth, 100mm, 4"

Sharp	170-714-100
Blunt	170-715-100



JANSEN
Self Retaining Retractor, 3x3 teeth, 100mm, 4"

Sharp	170-720-100
Blunt	170-723-100



WEITLANER-LOKTITE
Self Retaining Retractor, 2x3 teeth, 120mm, 4³/₄"

Blunt	170-749-105
Semi-sharp	170-750-105



COX
Ocular Shield incl. suction cup

24x21mm, S	400-850-240
25.5x22mm, M	400-850-255
26.5x23mm, L	400-850-265



NASAL RASPS





NASAL RASPS

TC Nasal Rasps

The major advantages of the RZ tungsten carbide rasps over conventional models are their superior rasping/cutting ability, increased longevity and a clean, precise tissue removal.



TC-Inserts										
	Fig. 1 0.8	Fig. 2 1.1	Fig. 3 1.3	Fig. 4 1.6	Fig. 5 1.8	Fig. 6 2.0	Fig. 7 2.4	Fig. 8 2.6	Fig. 9 2.8	Fig. 10 3.0



Fig. 1	420-491-165
Fig. 2	420-492-165
Fig. 3	420-493-165
Fig. 4	420-494-165
Fig. 5	420-495-165
Fig. 6	420-496-165
Fig. 7	420-497-165
Fig. 8	420-498-165
Fig. 9	420-499-165
Fig. 10	420-500-165

MALTZ
TC Nasal Rasp, 170mm, 6^{2/3}"



Fig. 1	420-491-230
Fig. 2	420-492-230
Fig. 3	420-493-230
Fig. 4	420-494-230
Fig. 5	420-495-230
Fig. 6	420-496-230
Fig. 7	420-497-230
Fig. 8	420-498-230

LAMB
TC Nasal Rasp, Ergo handle, 230mm, 9"



1:1 (Fig. 2 illustrated)

Fig. 2	420-480-200
Fig. 8	420-488-200

ASTON

TC Nasal Rasp, backward cutting, 200mm, 8"



1:1

1:1

Fig. 1/Fig. 2	420-660-219
Fig. 3/Fig. 4	420-660-214
Fig. 5/Fig. 6	420-660-216
Fig. 7/Fig. 8	420-660-218
Fig. 9/Fig. 10	420-660-220

FOMON

TC Nasal Rasp, 40x7mm, 210mm, 8^{1/4}"



1:1

Fig. 1	420-490-210
Fig. 2	420-491-210
Fig. 3	420-492-210
Fig. 4	420-493-210
Fig. 5	420-494-210
Fig. 6	420-495-210
Fig. 7	420-496-210
Fig. 8	420-497-210
Fig. 9	420-498-210
Fig. 10	420-499-210

PARKES

TC Nasal Rasp, 8x39mm, 210mm, 8^{1/4}"



1:1

ORIGINAL MALTZ

TC Nasal Rasp, 180mm, 7"

Backward cutting	420-672-000
Forward cutting	420-672-004



1:1

GLABELLA

TC Nasal Rasp, 210mm, 8¹/₄"

Coarse	420-668-210
Medium	420-669-210



1:1

AUFRICT (PEET)

Nasal Rasp, fine, curved, 25x7mm, diamond dusted

210mm, 8 ¹ / ₄ "	420-650-101
--	-------------



1:1

PEET-COTTLE

Nasal Rasp, curved, RZ diamonds, 190mm, 7¹/₂"

Curved	420-650-100
Straight	420-650-050

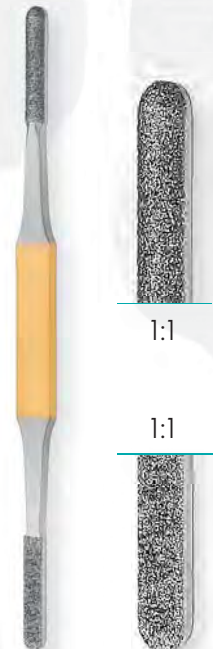

1:1

1:1

FOMON

Rasp, coarse, convex on flat, 40x7mm, diamond dusted

210mm, 8 ¹ / ₄ "	420-653-000
--	-------------

Diamond dusted rasps are mainly used for final finishing.



NASAL RASPS

Double-ended Nasal Rasps

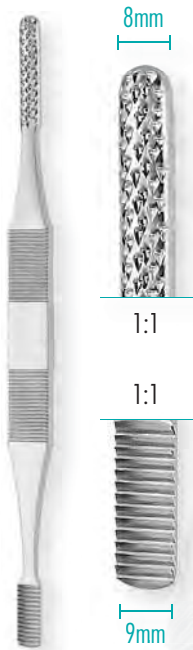

FRIEDMAN
Nasal Rasp, coarse, round/flat

210mm, 8^{1/4}"

420-677-210

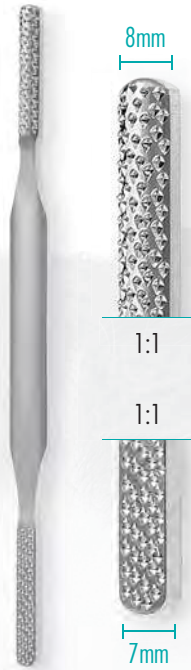

FOMON
Rasp, coarse, round/flat

215mm, 8^{1/2}"

420-660-000

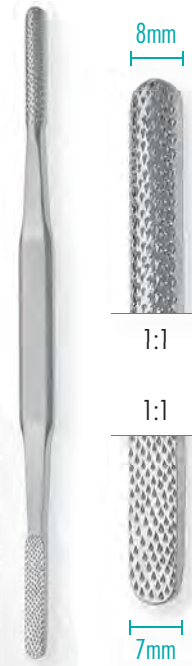

FOMON
Rasp, fine, round/flat

215mm, 8^{1/2}"

420-661-000

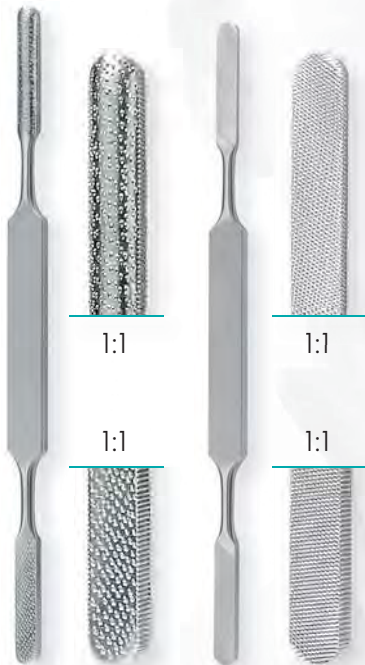

FOMON
Rasp, 4 sides, round/flat, fine/course

210mm, 8^{1/4}"

420-661-100



FOMON
Rasp, coarse, lightweight handle design

215mm, 8^{1/2}"

420-662-001



FOMON
Rasp, fine, lightweight handle design

215mm, 8^{1/2}"

420-662-002





1:1

BARSKY-GLABELLA

Nasal Rasp, backward cutting, curved

175mm, 6⁷/₈"

420-756-180



1:1

MCINDOE

Nasal Rasp, straight, 180mm, 7"

Backward cutting

420-655-180

Forward cutting

420-656-180



1:1

ORIGINAL MALTZ

Nasal Rasp, straight, 165mm, 6¹/₂"

Backward cutting

420-654-180

Forward cutting

420-657-180

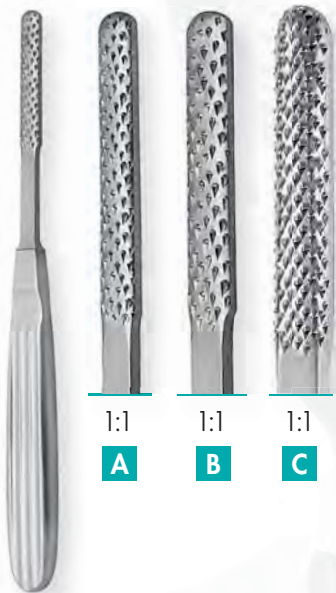

1:1

A

1:1

B

1:1

C

LAMONT

Nasal Rasp, backward cutting, straight, 175mm, 6⁷/₈"

A Delicate

420-690-200

B Standard

420-691-200

C Wide

420-692-200



1:1

AUFRICHT

Nasal Rasp, curved, 210mm, 8¹/₄"

Forward cutting

420-650-001

Backward cutting

420-650-002



1:1

COTTLE

Nasal Rasp, backward cutting, straight

210mm, 8¹/₄"

420-670-210



NASAL RASPS

Conventional Nasal Rasps
Fomon Modular Nasal Rasp System



1:1

GALLAHER

Nasal Rasp, with ring, coarse

170mm, 6²/₃"

420-678-190



1:1

WATSON-WILLIAMS

Nasal Rasp, convex blade, knee bent, 170mm, 6²/₃"

Fine

420-520-170

Coarse

420-521-170

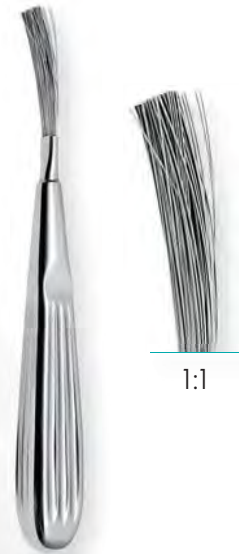

1:1

Wire Brush for cleaning Rasps

165mm, 6¹/₂"

260-500-001

FOMON MODULAR Nasal Rasp System



420-660-200

Fomon Nasal Rasp Holder, double-ended



420-660-100

Fomon Nasal Rasp Holder, single ended



420-660-500

Fomon TC Nasal Rasp Set, complete in sterilization tray, incl. 10 inserts, 1 key and 2 handles (single+double)



420-660-101 Fomon TC Insert, Fig. 1



420-660-102 Fomon TC Insert, Fig. 2



420-660-103 Fomon TC Insert, Fig. 3



420-660-104 Fomon TC Insert, Fig. 4



420-660-105 Fomon TC Insert, Fig. 5



420-660-106 Fomon TC Insert, Fig. 6



420-660-107 Fomon TC Insert, Fig. 7



420-660-108 Fomon TC Insert, Fig. 8



420-660-109 Fomon TC Insert, Fig. 9



420-660-110 Fomon TC Insert, Fig. 10



420-660-150 Key for nasal rasps on the handle



RZ
Medizintechnik
GmbH

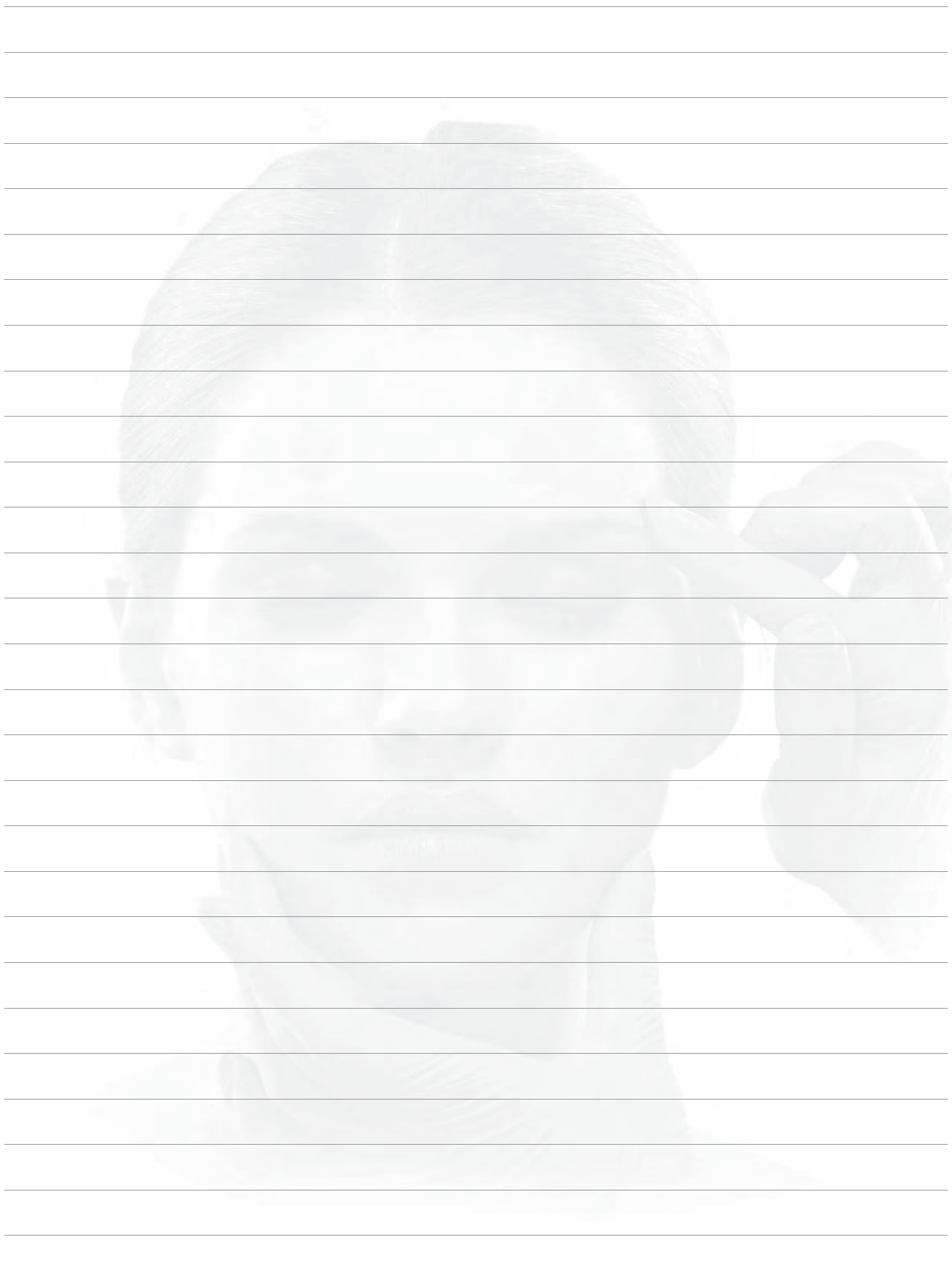



CHISELS & OSTEOTOMES



Osteotomes

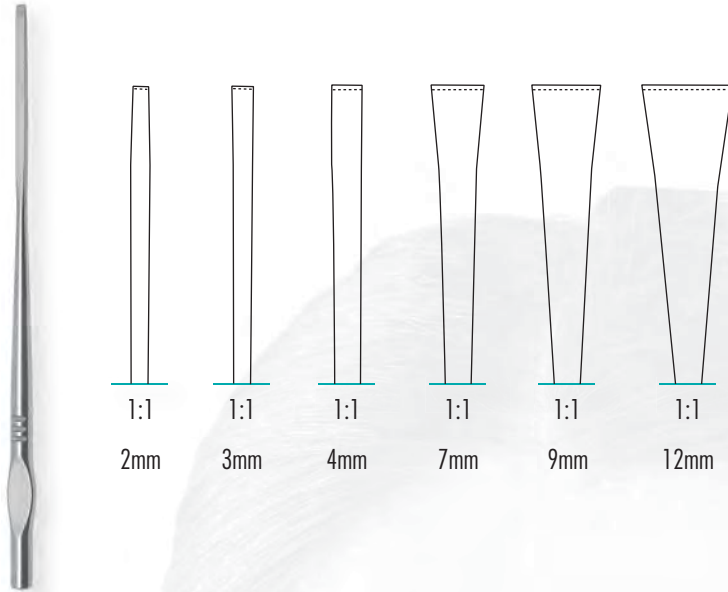

WALTER
Osteotome, 190mm, 7^{1/2}"

MATTHEW
Osteotome, 180mm, 7"

2mm	420-580-002	7mm	420-580-007
3mm	420-580-003	9mm	420-580-009
4mm	420-580-004	12mm	420-580-012

11mm	420-503-011
------	-------------

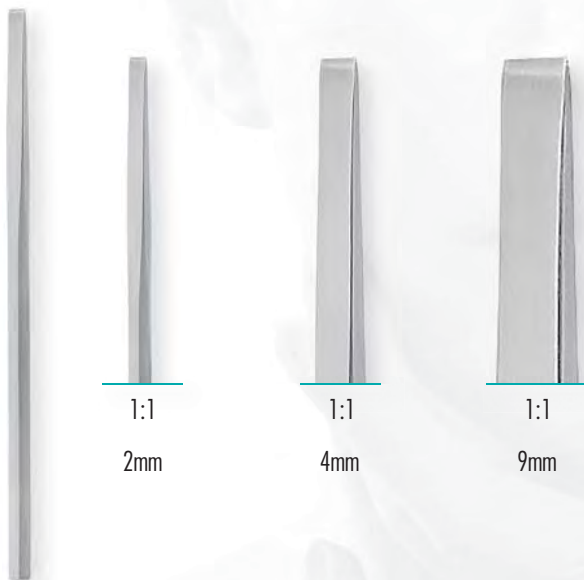

SHEEHAN
Osteotome, 175mm, 6^{3/4}"

REES
Osteotome, 200mm, 8", with aluminum handle

2mm	420-594-002	9mm	420-594-009
3mm	420-594-003	10mm	420-594-010
4mm	420-594-004	11mm	420-594-011
5mm	420-594-005	12mm	420-594-012
6mm	420-594-006	15mm	420-594-015
8mm	420-594-008		

3.0 mm	420-500-200
--------	-------------



CHISELS & OSTEOTOMES

Osteotomes



2mm
H

1:1

RZ

Osteotome, 180mm, 7"

2mm	420-568-002	8mm	420-568-008
4mm	420-568-004	10mm	420-568-010
6mm	420-568-006		

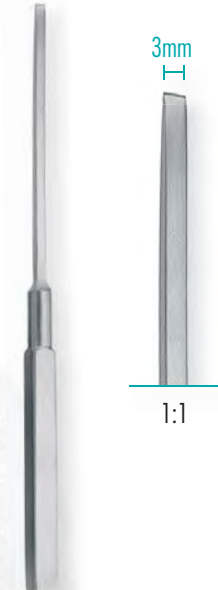

3mm
H

1:1

WARD

Osteotome, 180mm, 7"

3mm	420-495-003
4mm	420-495-004
5mm	420-495-005

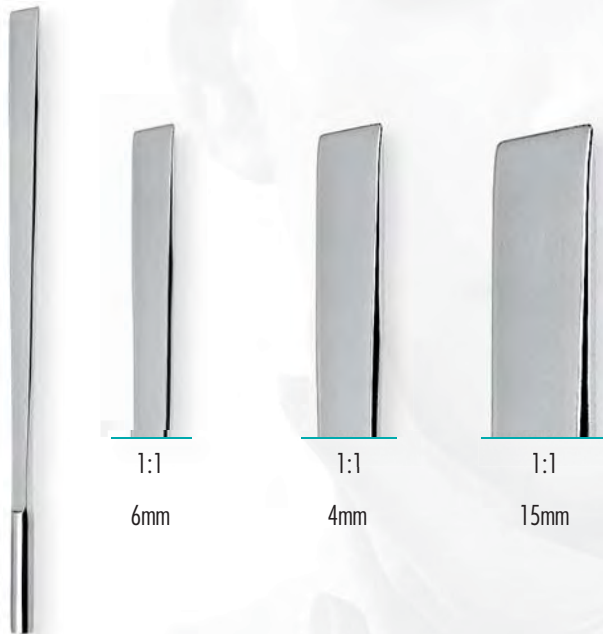

1:1

6mm

1:1

4mm

1:1

15mm

JAYES

Osteotome, 190mm, 7^{1/2}"

2mm	420-501-002	10mm	420-501-010
4mm	420-501-004	12mm	420-501-012
6mm	420-501-006	15mm	420-501-015
8mm	420-501-008		



8mm
H

1:1

ROZNER

Osteotome, double guarded on the inclined cutting edge

180mm, 7"	420-507-010
-----------	-------------





1:1
9mm

FRENCH (GILLIES)

Osteotome, 140mm, 5^{1/2}"

5mm	420-490-005
7mm	420-490-007
9mm	420-490-009
11mm	420-490-011
13mm	420-490-013



1:1
14mm

RUBIN

Osteotome, 180mm, 7"

8mm	420-587-008
10mm	420-587-010
12mm	420-587-012
14mm	420-587-014
16mm	420-587-016



10mm

1:1
10mm

CINELLI

Osteotome, double guarded, 160mm, 6^{1/4}"

8mm	420-589-008
10mm	420-589-010
12mm	420-589-012
14mm	420-589-014
16mm	420-589-016

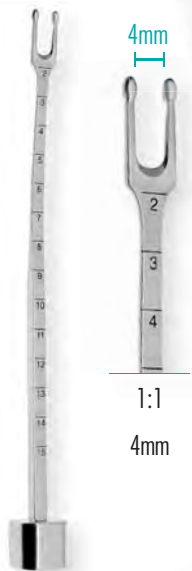

4mm
1:1
4mm

OBWEGESER

Osteotome, buttoned, U-shape cutting edge, 185mm, 7^{1/4}"

4mm	431-662-190
6mm	431-666-190
8mm	431-668-190



4mm
1:1

OBWEGESER

Osteotome, with V-tip, 175mm, 6^{3/4}"

Straight	420-460-004
Curved	420-460-005



1:1
6mm

EPKER

Osteotome, straight, 180mm, 7"

4mm	420-498-004
6mm	420-498-006
8mm	420-498-008



CHISELS & OSTEOTOMES

Osteotomes



1:1

SILVER

Osteotome, with guard, 180mm, 7"

Straight	420-459-001
Right curved	420-459-002
Left curved	420-459-003

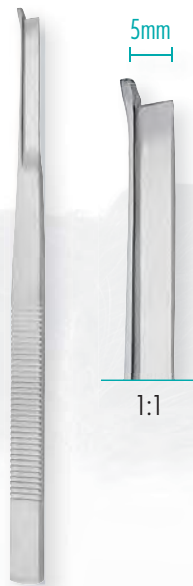

1:1

MASING

Osteotome, with guard, 180mm, 7"

Straight	420-459-101
Right curved	420-459-102
Left curved	420-459-103

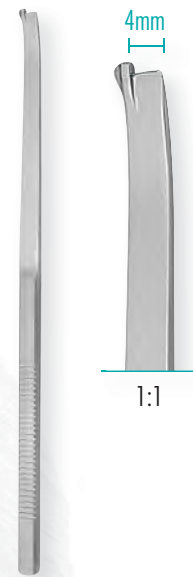

1:1

ANDERSON-NEIVERT

Osteotome, with guard, 180mm, 7"

Straight	420-639-001
Right curved	420-639-002
Left curved	420-639-003

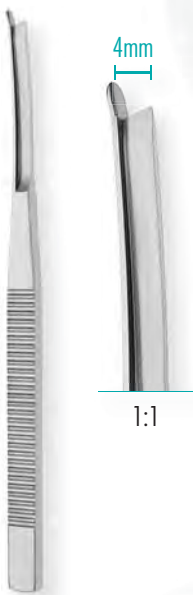

1:1

FRENCHAY

Osteotome, with guard, 180mm, 7"

Straight	420-491-000
Right curved	420-491-002
Left curved	420-491-001



1:1

FANOUS-GUBISCH

Osteotome, straight, 4mm wide, 200mm, 8" with guard

Straight	420-640-001
Right curved	420-640-002
Left curved	420-640-003



1:1

BRAITHWAITE

Nasal Chisel, 5mm wide, 145mm, 5³/₄"

Guard left	420-485-005
Guard right	420-486-005
Without guard	420-487-005



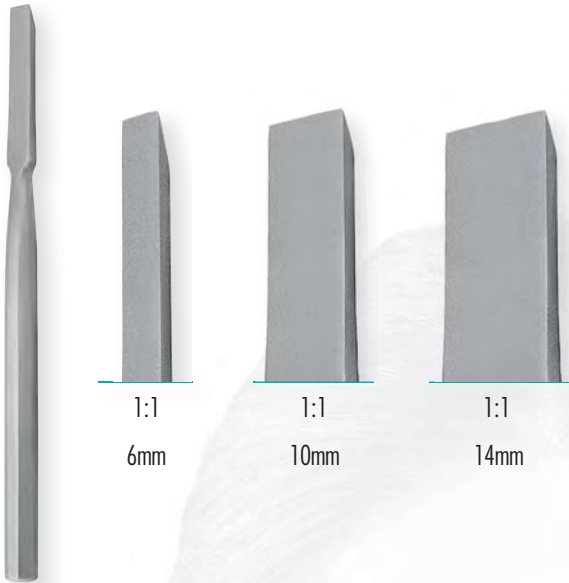

1:1
6mm

1:1
10mm

1:1
14mm



1:1

JENKINS

Nasal Chisel, 145mm, 4"

2mm	420-494-002	10mm	420-494-010
4mm	420-494-004	12mm	420-494-012
6mm	420-494-006	14mm	420-494-014
8mm	420-494-008		

MCINDOE

Nasal Chisel with Mushroom head, 150mm, 6"

9mm	420-487-009
11mm	420-487-011
13mm	420-487-013
15mm	420-487-015



1:1

COTTLE

Nasal Chisel, black coated, 5mm, 7¹/₄"

5mm	420-505-005	11mm	420-505-011
7mm	420-505-007	16mm	420-505-016
9mm	420-505-009		



1:1

MCINDOE

Nasal Chisel, 150mm, 6"

9mm	420-488-009
11mm	420-488-011
13mm	420-488-013
15mm	420-488-015



CHISELS & OSTEOTOMES

Chisels & Gouges



1:1

COTTLE

Chisel, graduated, 185mm, 7¹/₄"

4mm	210-488-004	8mm	210-488-008
6mm	210-488-006	9mm	210-488-009
7mm	210-488-007	12mm	210-488-012

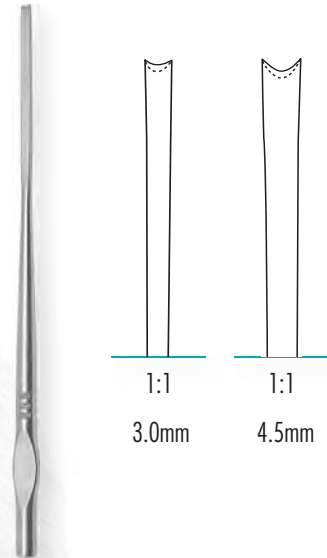

1:1
3.0mm

1:1
4.5mm

WALTER

Chisel with notch, double guarded, 190mm, 7¹/₂"

3.0mm	420-582-003
4.5mm	420-582-045



1:1

READ

Nasal Gouge, 180mm, 7"

3mm	420-492-003
4mm	420-492-004
5mm	420-492-005
6mm	420-492-006



1:1

KILLIAN

Septum Gouge, round cutting edge, 170mm, 6³/₄"

6mm	420-552-170
-----	-------------



1:1

KILLIAN-CLAUS

Septum Gouge, notched cutting edge, 170mm, 6³/₄"

6mm	420-551-170
-----	-------------



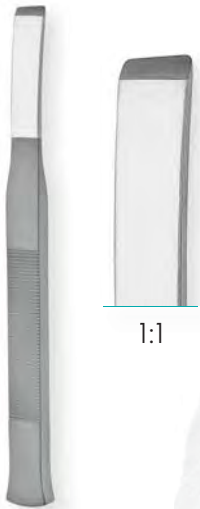

1:1

TESSIER

Osteotome, straight, 160mm, 6¹/₄"

2mm	420-502-002	10mm	420-502-010
3mm	420-502-003	15mm	420-502-015
5mm	420-502-005	18mm	420-502-018
7mm	420-502-007		



1:1

TESSIER

Osteotome, curved, 200mm, 8"

10mm	420-502-211
15mm	420-502-216

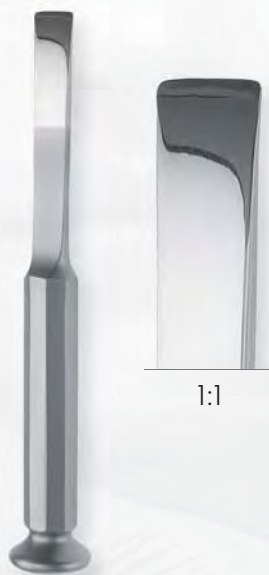

1:1

TESSIER

Osteotome, straight, 200mm, 8"

10mm	420-502-210
15mm	420-502-215



CHISELS & OSTEOTOMES

Osteotomes



1:1

OBWEGESER

Osteotome, curved, 230mm, 9"

8mm	431-643-008
11mm	431-643-011



1:1

OBWEGESER

Osteotome, thin blade, 220mm, 8³/₄"

8mm	431-645-008
12mm	431-645-012
16mm	431-645-016



1:1

OBWEGESER-RAMUS

Osteotome, wedge-shaped, 220mm, 8³/₄"

8mm	431-646-008
12mm	431-646-012
16mm	431-646-016



1:1

OBWEGESER

Osteotome, tapered, 220mm, 8³/₄"

7mm	431-645-007
10mm	431-645-010

More Osteotomes and Chisels in our comprehensive ORTHOPAEDICS catalogue.



OSTEOTOME

CHISEL



ADVANCED RHINOPLASTIC SET

420-990-004



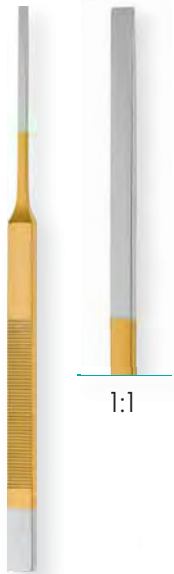

1:1

Micro Osteotome
185mm, 7^{1/4}"

2.0mm	420-700-020
2.5mm	420-700-025
3.0mm	420-700-030



1:1

Micro Osteotome
with guard, 185mm, 7^{1/4}"

2.2mm	420-700-022
-------	-------------



1:1

Micro Osteotome
185mm, 7^{1/4}"

10mm	420-700-100
12mm	420-700-120
14mm	420-700-140



1:1

JOSEPH
Periosteal Elevator, 180mm, 7"

3mm	420-700-430
-----	-------------



1:1

Skin Hook
2 prongs, 10mm wide

120mm, 4 ^{3/4} "	420-700-210
---------------------------	-------------



1:1

Micro Skin Hook
155mm, 6"

1 prong	420-700-001
2 prongs	420-700-002



RHINOPLASTIC SET

Rasps, Retractors, Forceps,
& Needle Holders



1:1

Glabella Rasp
8mm wide

185mm, 7¹/₄"

420-700-400



1:1

1:1

TC Nasal Rasp
double-ended, 200mm, 7³/₄"

Medium

420-700-501

Medium & fine

420-700-502



AUFRICT

Nasal Retractor, 160mm, 6¹/₄"

160mm, 6¹/₄"

420-700-200

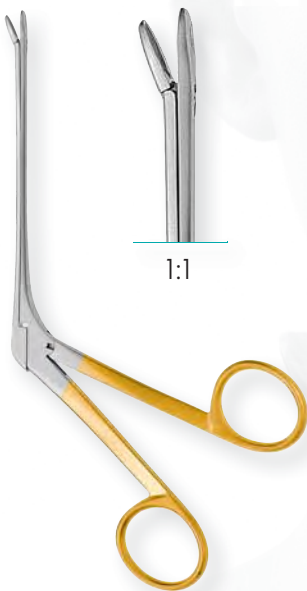

1:1

BLAKESLEY

Nasal Forceps, delicate, 110mm, 4¹/₂"

110mm, 4¹/₂"

420-700-700



1:1

HALSEY

TC Needle Holder, 130mm, 5"

130mm, 5"

420-700-330





1:1

KILNER
Dissecting Scissors

140mm, 5¹/₂"

420-700-340



1:1

Rhinoplasty Scissors
sharp, 100mm, 4"

Straight

420-700-610

Curved

420-700-611



1:1

WALTER
Scissors, angled

100mm, 4"

420-700-620



1:1

ADSON-BROWN

Tissue Forceps, lateral grasping teeth with 7x7 brown teeth

120mm, 4³/₄"

420-700-630



1:1

ADSON

Dressing Forceps

120mm, 4³/₄"

420-700-640



1:1

ADSON

Tissue Forceps, 1x2 teeth

120mm, 4³/₄"

420-700-650



MALLETS





Weight	240g
Diameter	30mm

COTTLE

Mallet, with plain and convex side

190mm, 7¹/₂"

210-240-180



Weight	140g
Diameter	25mm

BERGMANN

Mallet, with exchangeable plastic discs

185mm, 7¹/₄"

210-264-140

Spare plastic discs

One pair

210-265-000



Weight	320g
Diameter	27mm

MEAD

Mallet, with exchangeable plastic discs

190mm, 7¹/₂"

210-262-170

Spare plastic discs

One pair

210-263-000



Weight	130g
Diameter	27mm

HAJEK

Mallet

220mm, 8³/₄"

210-244-220



Weight	117g
Diameter	19mm

RZ

Mallet, with copper head

170mm, 6²/₃"

210-019-170

More mallets in our comprehensive ORTHOPAEDICS catalogue.

NASAL SPECULA





THUDICHUM (MARK HOVELL)
Nasal Speculum, non-insulated

Blade size	Total length	Order Number
8.5 x 6mm	70mm	420-050-001
9 x 7mm	70mm	420-050-002
12.5 x 8mm	70mm	420-050-003
15 x 8.5mm	70mm	420-050-004
16.5 x 9mm	70mm	420-050-005
18 x 10mm	70mm	420-050-006
19.5 x 10.5mm	70mm	420-050-007



THUDICHUM (MARK HOVELL)
Nasal Speculum, insulated

Blade size	Total length	Order Number
8.5 x 6mm	70mm	420-050-101
9 x 7mm	70mm	420-050-102
12.5 x 8mm	70mm	420-050-103
15 x 8.5mm	70mm	420-050-104
16.5 x 9mm	70mm	420-050-105
18 x 10mm	70mm	420-050-106
19.5 x 10.5mm	70mm	420-050-107

8.5 x 6 mm

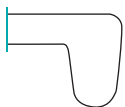

9 x 7 mm



12.5 x 8 mm

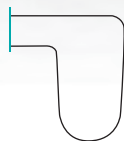

15 x 8.5mm

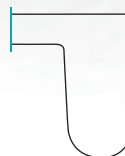

16.5 x 9 mm

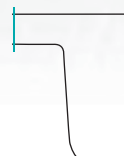

18 x 10mm

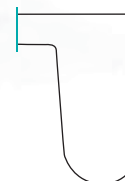

19.5 x 10.5mm

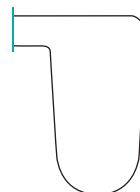



NASAL SPECULA

St. Claire Thompson
Nasal Specula

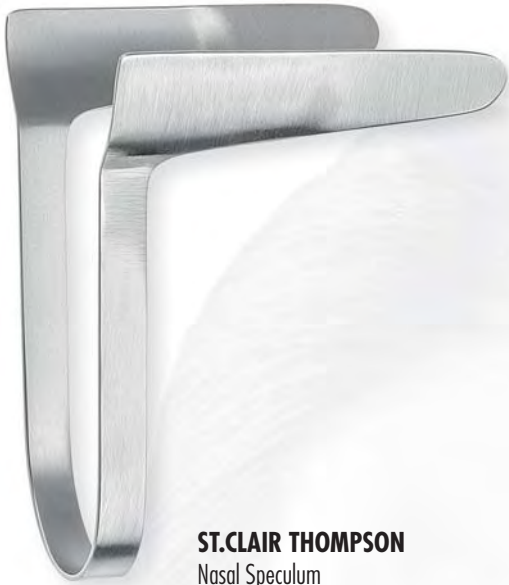

ST. CLAIR THOMPSON
Nasal Speculum

Blade length	Total length	Order Number
38mm	73mm	420-052-001
50mm	73mm	420-052-002
65mm	73mm	420-052-003
75mm	73mm	420-052-004

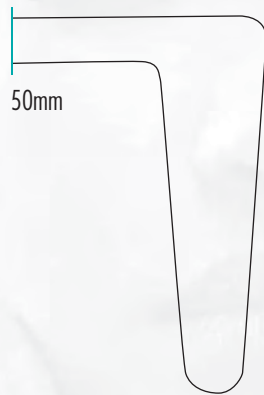
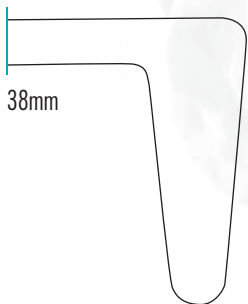

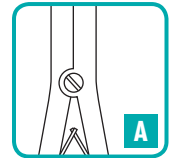

Blade length	Total length	A - Without locking screw
28mm	140mm	420-100-001
30mm	140mm	420-100-002
32mm	140mm	420-100-003

WIENER MODELL
Nasal Speculum, screw joint

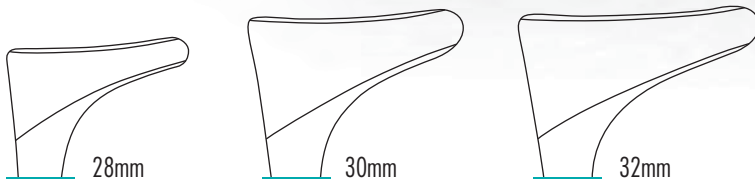



NASAL SPECULA

Hartmann-Halle
Nasal Specula

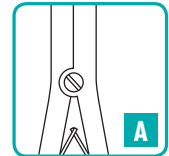

Blade length	Total length	A - Without locking screw
29mm	155mm	420-120-150
33mm	155mm	420-122-150
37mm	155mm	420-123-150

HARTMANN-HALLE

Nasal Speculum, tapered blade, screw joint

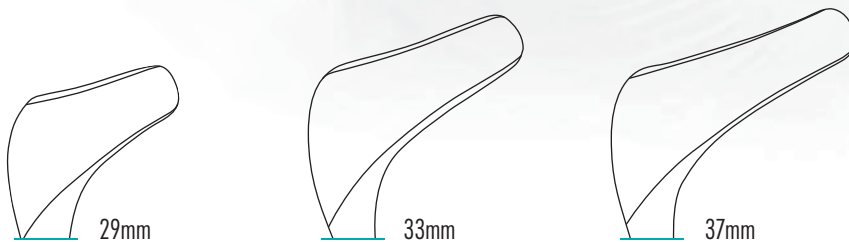

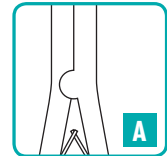

Blade length	Total length	A - Without locking screw
29mm	155mm	420-124-029
33mm	155mm	420-124-033
37mm	155mm	420-124-037

HARTMANN-HALLE
Nasal Speculum, tapered blade, aseptic joint

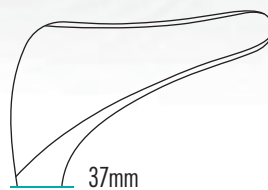
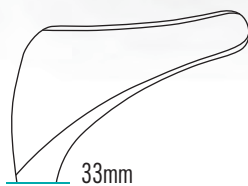
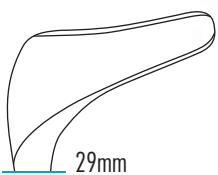



NASAL SPECULA

Hartmann
Nasal Specula

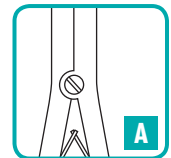

Blade length	Total length	A - Without locking screw
27mm	160mm	420-119-001
30mm	160mm	420-119-002
34mm	160mm	420-119-003

HARTMANN
Nasal Speculum, screw joint

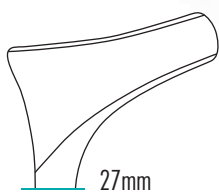

27mm

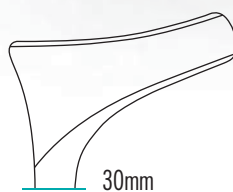

30mm

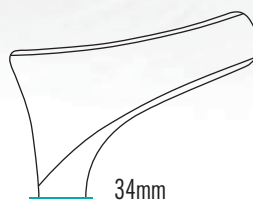

34mm

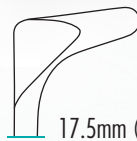
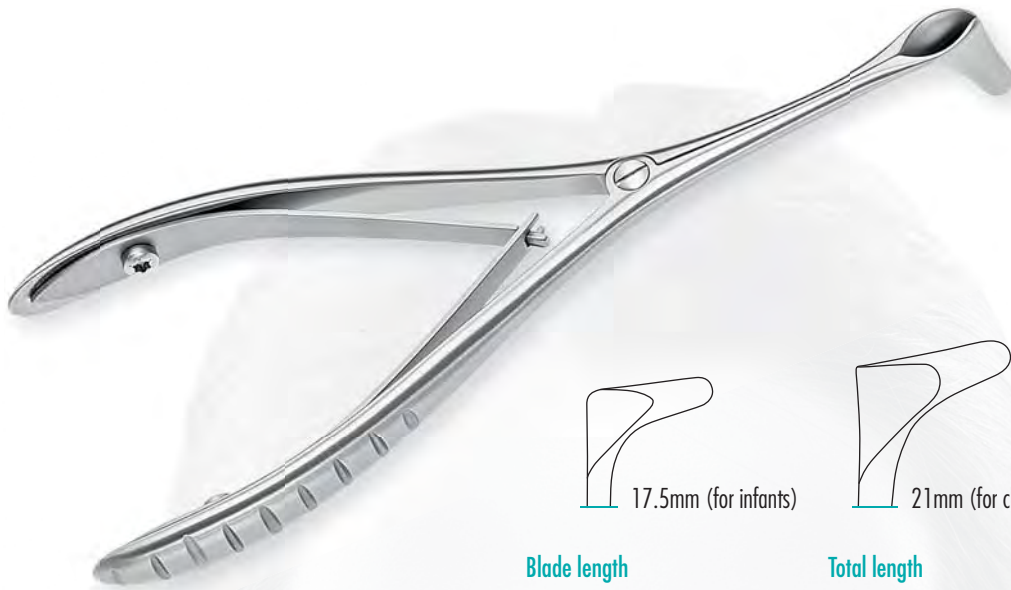

17.5mm (for infants)



21mm (for children)

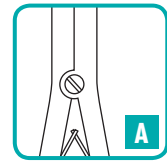

Blade length

Total length

A - Without locking screw

17.5mm (for infants)

130mm

420-140-135

21mm (for children)

130mm

420-142-135

HALLE-TIECK

Nasal Speculum, screw joint

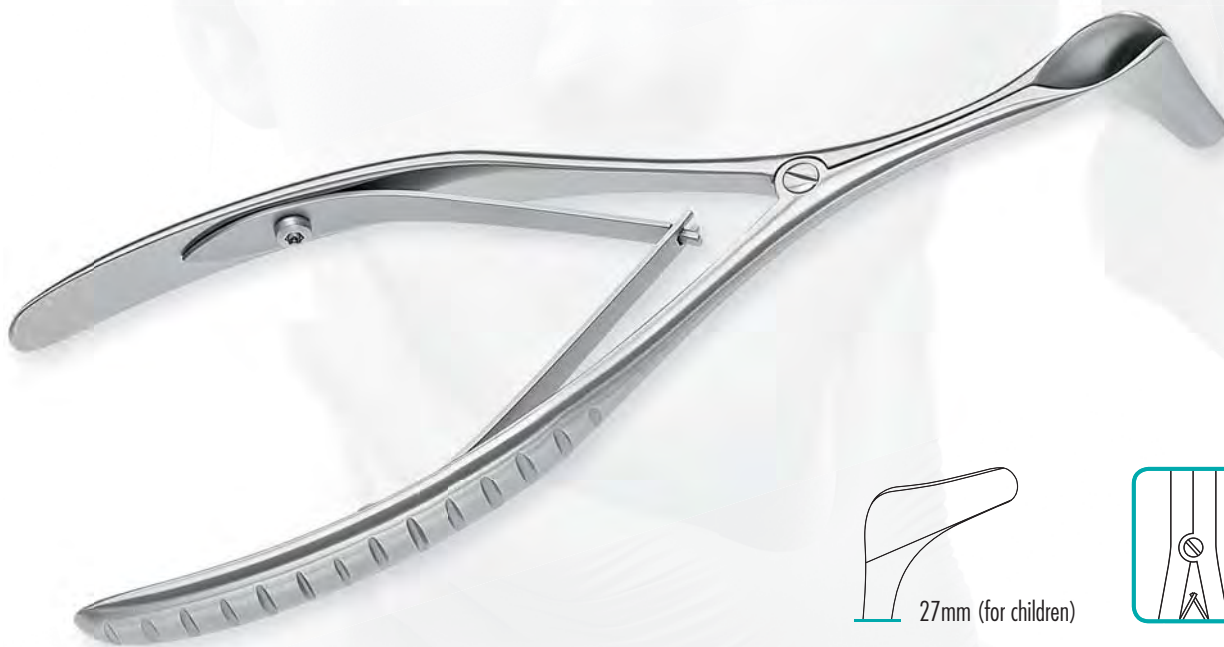

27mm (for children)

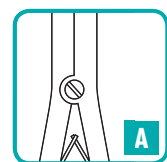

Blade length

Total length

A - Without locking screw

27mm (for children)

150mm

420-150-150

HARTMANN-HALLE MOD. SONNENSCHN

Nasal Speculum, screw joint



NASAL SPECULA

Beckmann
Nasal Specula

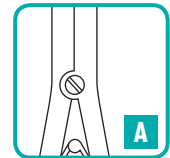
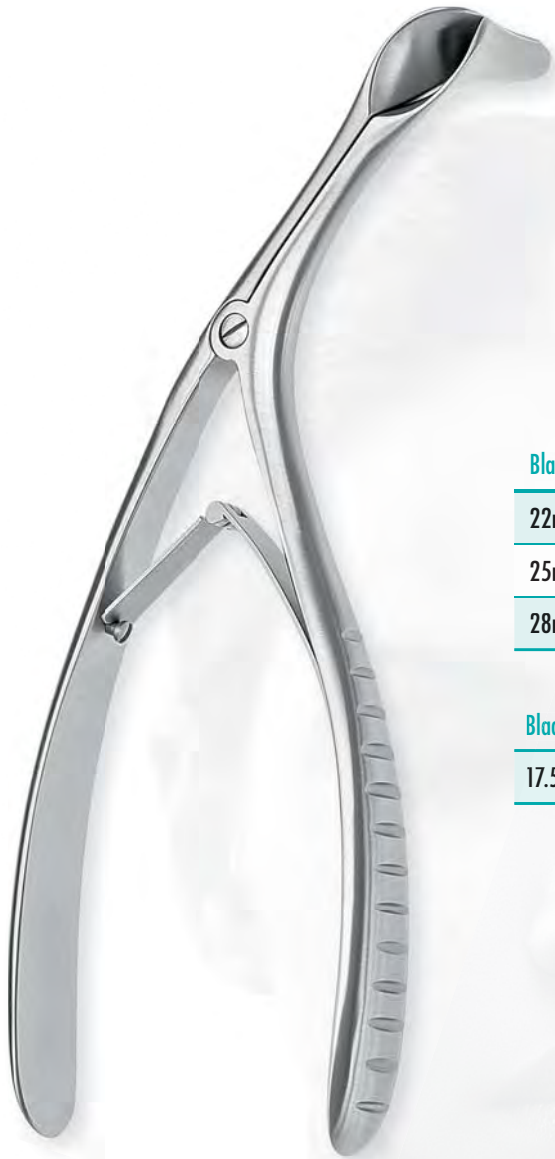

Blade length	Total length	A - Without locking screw
22mm	150mm	420-148-150
25mm	150mm	420-146-152
28mm	155mm	420-146-153

Blade length	Total length	A - Without locking screw
17.5mm (for infants)	130mm	420-147-140

BECKMANN
Nasal Speculum, screw joint

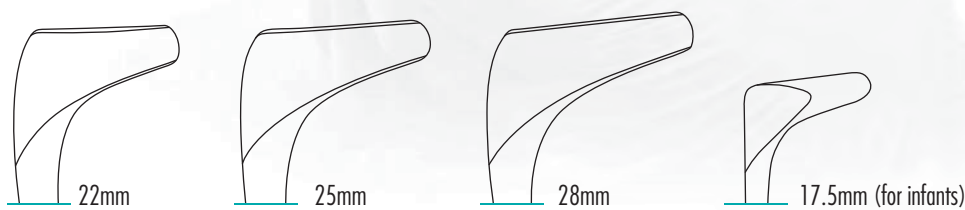

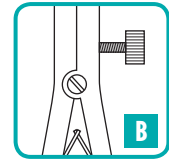
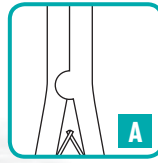
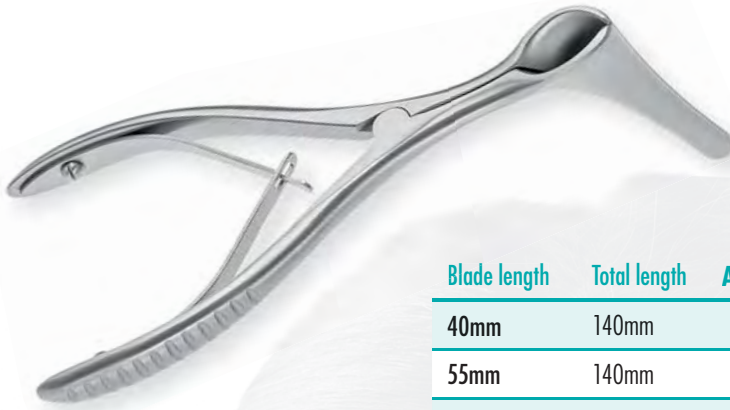

Blade length	Total length	A - Without locking screw, aseptic joint	B - With locking screw, screw joint
40mm	140mm	420-143-040	420-148-040
55mm	140mm	420-143-055	420-148-055
75mm	140mm	420-143-075	420-148-075
90mm	140mm	420-143-090	420-148-090

KILLIAN STANDARD
Nasal Speculum

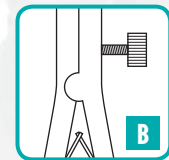
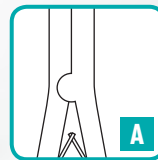
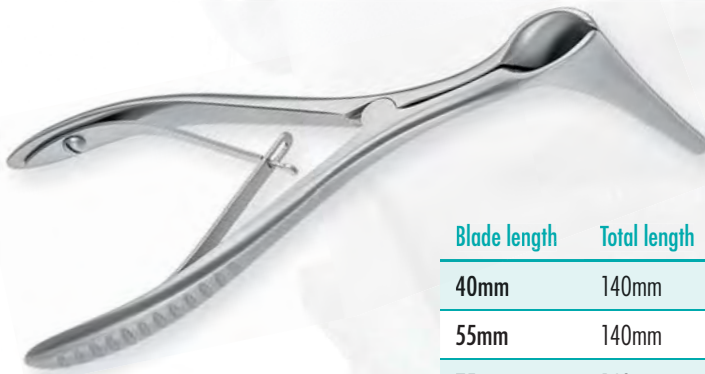
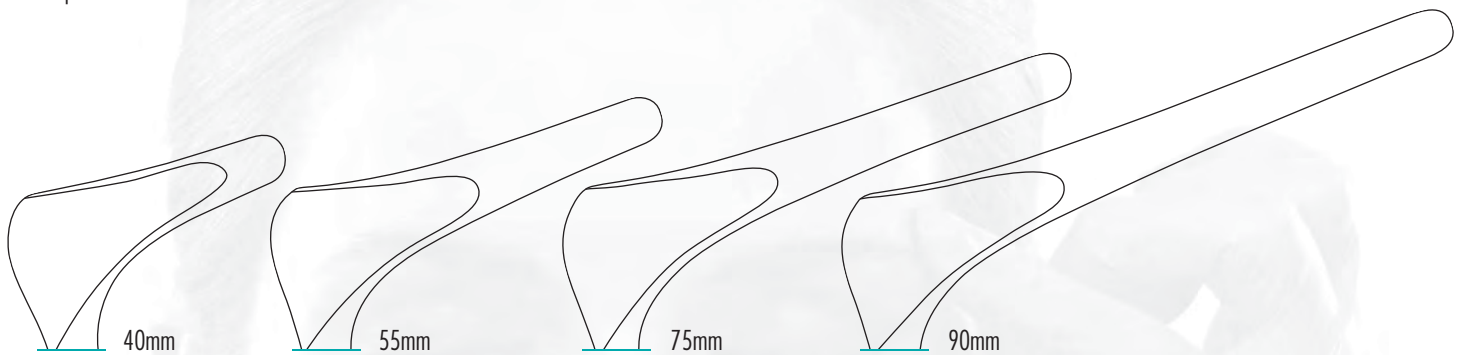

Blade length	Total length	A - Without locking screw	B - With locking screw
40mm	140mm	420-144-040	420-141-040
55mm	140mm	420-144-055	420-141-055
75mm	140mm	420-144-075	420-141-075
90mm	140mm	420-144-090	420-141-090

KILLIAN
Nasal Speculum, tapered blades, aseptic joint

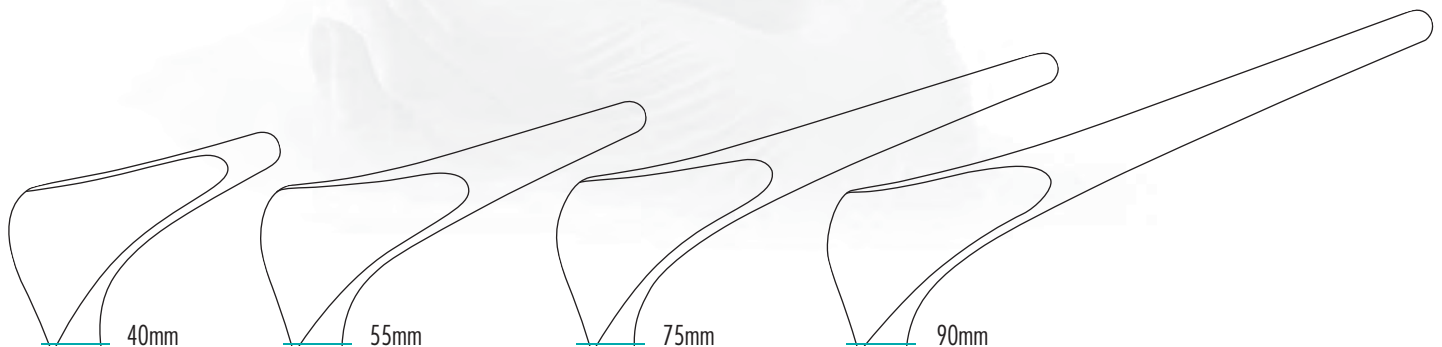



NASAL SPECULA

Killian-Walter, Walter
Nasal Specula

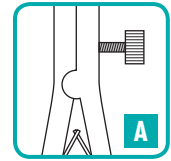
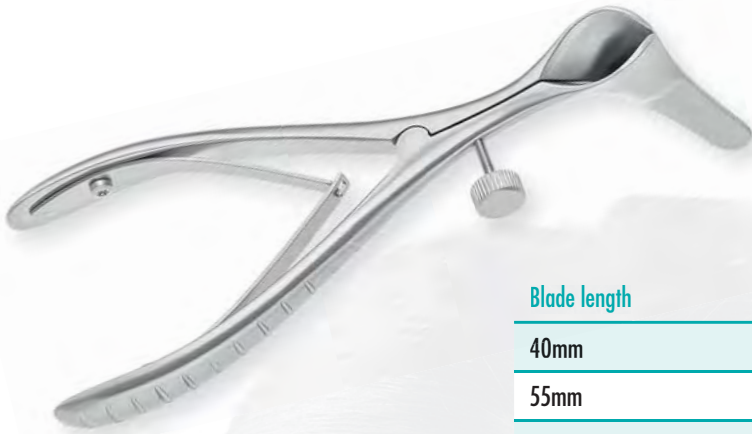

Blade length	Total length	A - With locking screw
40mm	140mm	420-138-040
55mm	140mm	420-138-055
75mm	140mm	420-138-075
90mm	140mm	420-138-090

KILLIAN-WALTER
Nasal Speculum, thin blades, aseptic joint

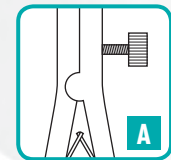
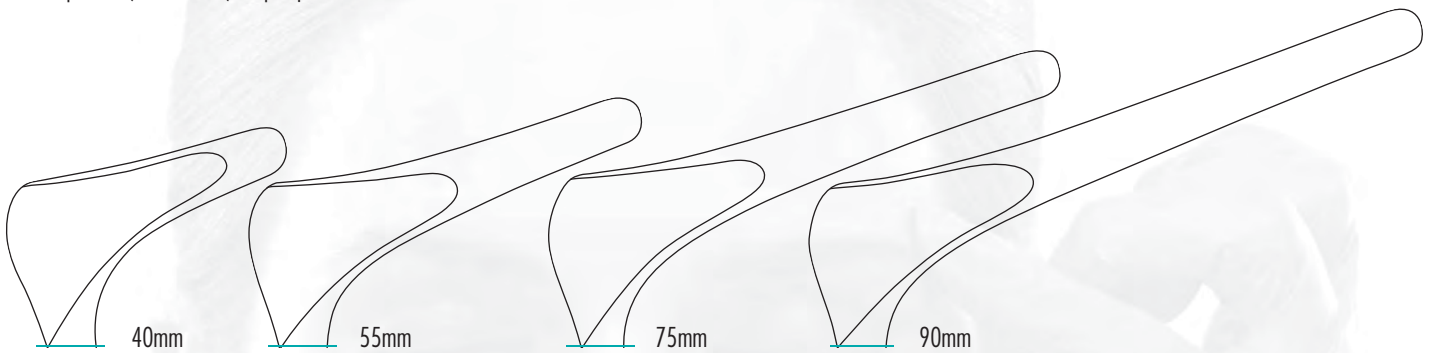

Blade length	Total length	A - With locking screw
35mm	130mm	420-139-035
55mm	130mm	420-139-055
75mm	130mm	420-139-075

WALTER
Nasal Speculum, very thin blade, aseptic joint

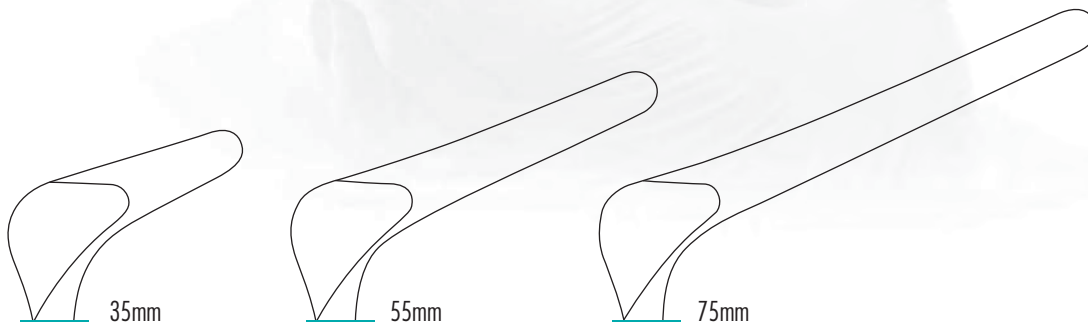

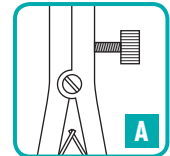

Blade length	Total length	A - With locking screw
30mm	135mm	420-136-020
35mm	135mm	420-136-035
55mm (tapered blade)	140mm	420-134-050
55mm	135mm	420-136-055
70mm	135mm	420-136-070
80mm	135mm	420-136-080
90mm	140mm	420-136-090

KILLIAN-COTTLE
Nasal Speculum, screw joint

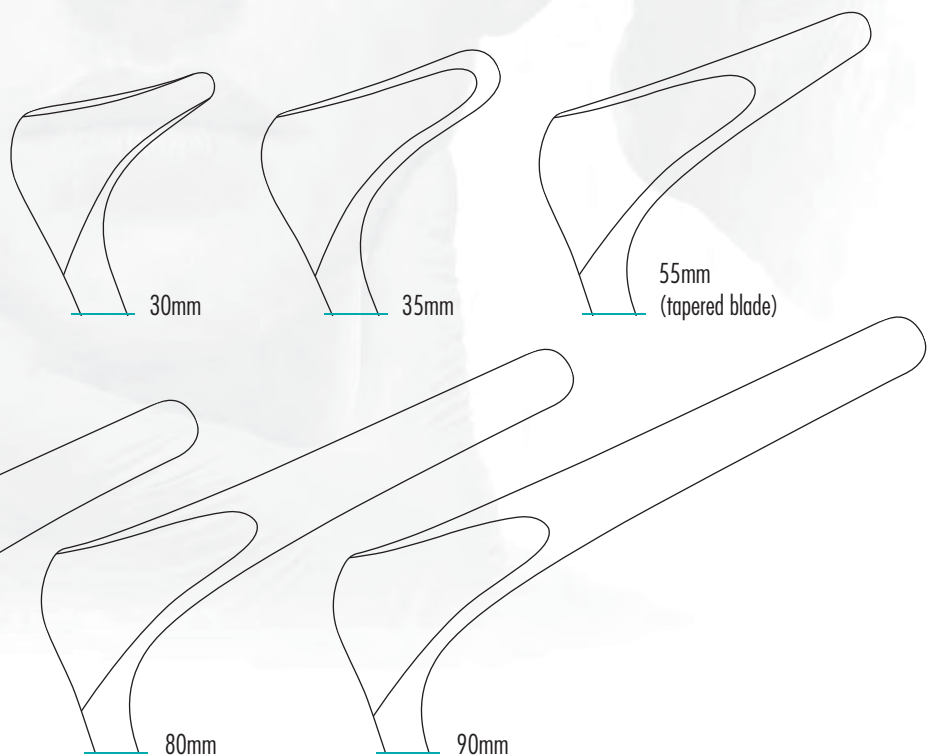



NASAL SPECULA

Killian-Struycken
Nasal Specula

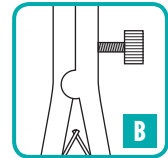
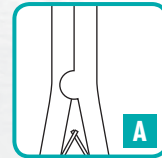

Blade length	Total length	A - Without locking screw	B - With locking screw
40mm	140mm	420-147-040	420-146-040
55mm	140mm	420-147-055	420-146-055
75mm	140mm	420-147-075	420-146-075
90mm	140mm	420-147-090	420-146-090

KILLIAN-STRUYCKEN
Nasal Speculum, aseptic joint

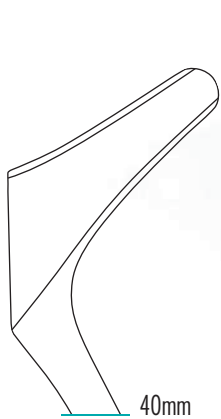

40mm

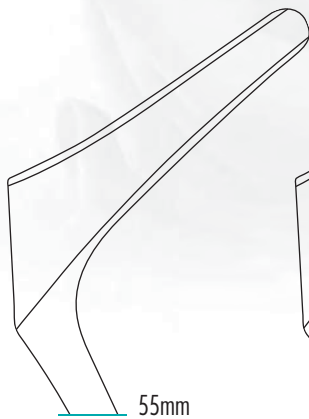

55mm



75mm



90mm



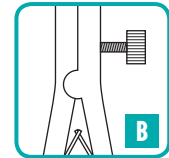
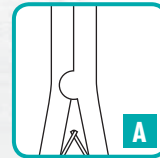

Blade length	Total length	A - Without locking screw	B - With locking screw
35mm	130mm	420-132-035	420-135-035
55mm	130mm	420-132-055	420-135-055
75mm	130mm	420-132-075	420-135-075
90mm	130mm	420-132-090	420-135-090

COTTLE
Nasal Speculum, aseptic joint

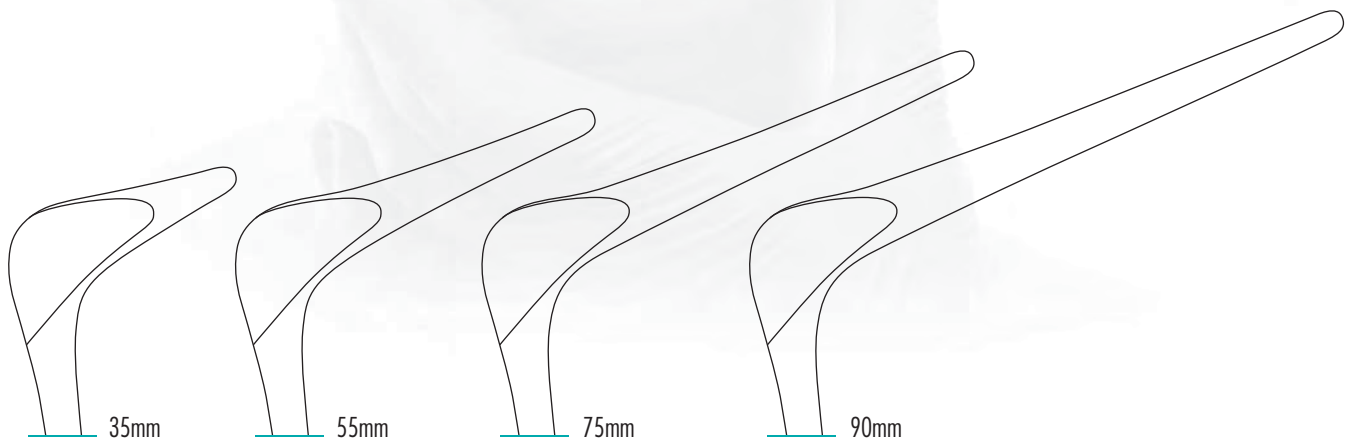



NASAL SPECULA

Killian
Nasal Specula

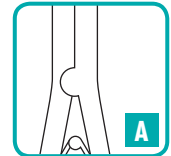
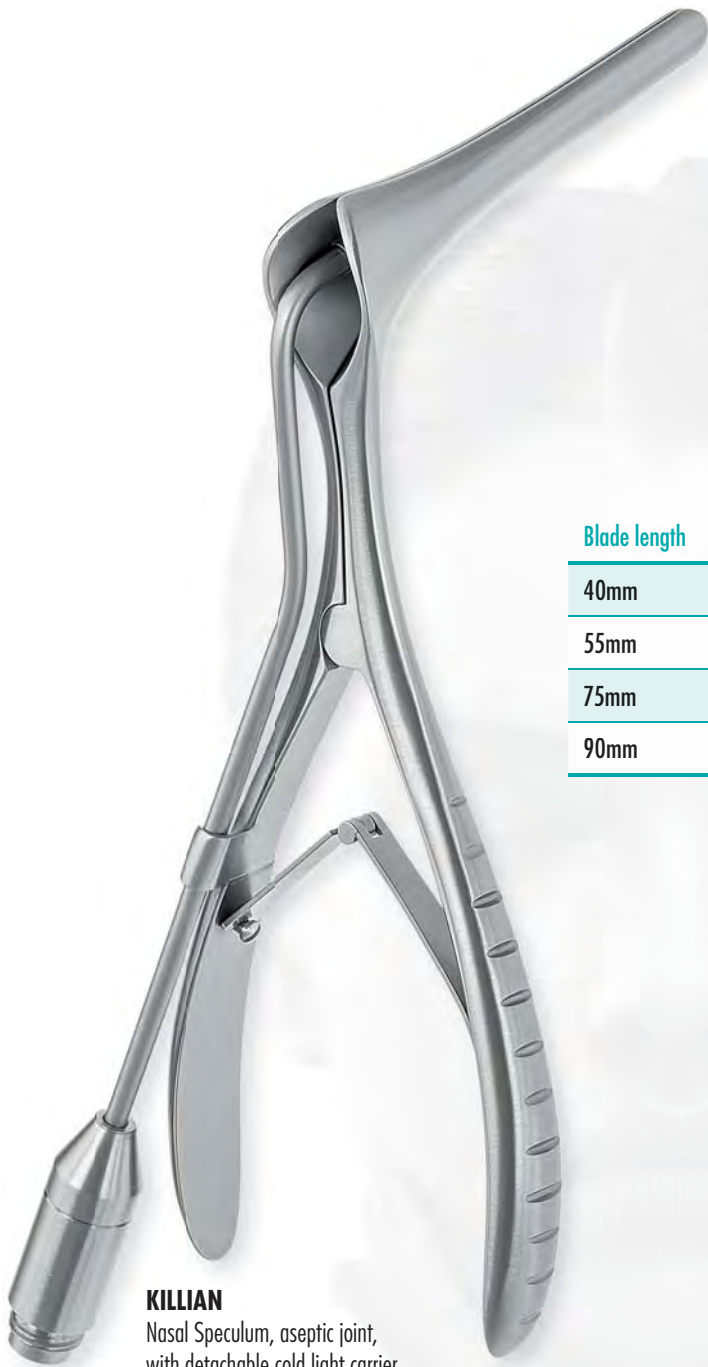

Blade length Total length A - Without locking screw

40mm	140mm	420-743-040
55mm	140mm	420-743-055
75mm	140mm	420-743-075
90mm	140mm	420-743-090

KILLIAN
Nasal Speculum, aseptic joint,
with detachable cold light carrier

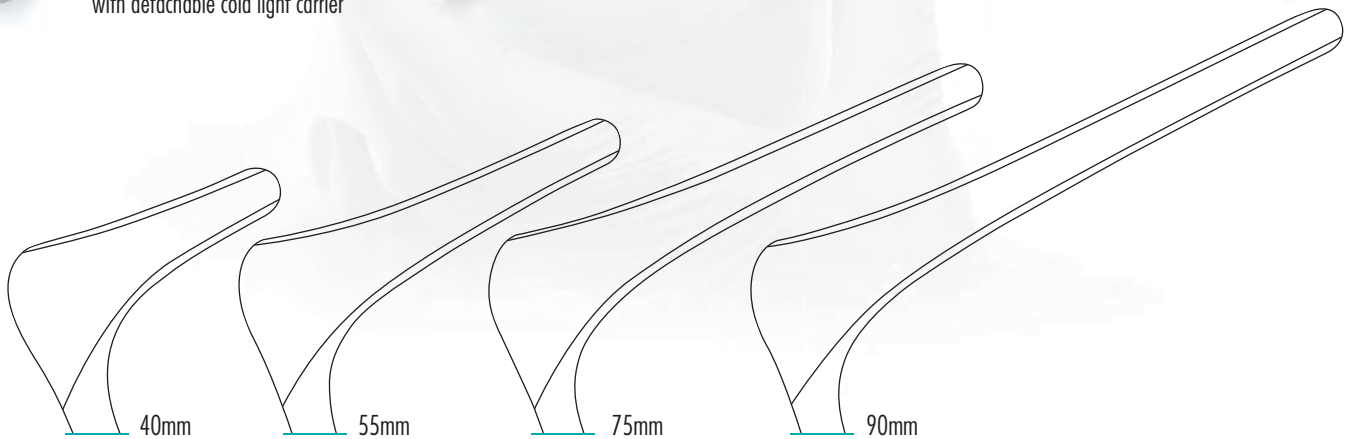

For use with fibre-optic cables (see page 248).



COTTLE-MASING

Nasal Speculum, aseptic joint, for flexible arm

Blade length	Total length	A - With locking screw
35mm	140mm	420-140-035
50mm	140mm	420-140-050
75mm	140mm	420-140-075
90mm	140mm	420-140-090
100mm	140mm	420-140-100
Flexible Arm complete with holding rod		251-010-000
Nasal Specula Clamp for Flexible Arm		251-010-400



SINUS

Nasal Speculum, aseptic joint, for flexible arm

Blade length left	Blade length right	Total length	A - With locking screw
55mm	35mm	140mm	420-150-101
35mm	55mm	140mm	420-150-102
75mm	35mm	140mm	420-150-105
35mm	75mm	140mm	420-150-106
75mm	52mm	140mm	420-150-107
52mm	75mm	140mm	420-150-108
Flexible Arm complete with holding rod			251-010-000
Nasal Specula Clamp for Flexible Arm			251-010-400

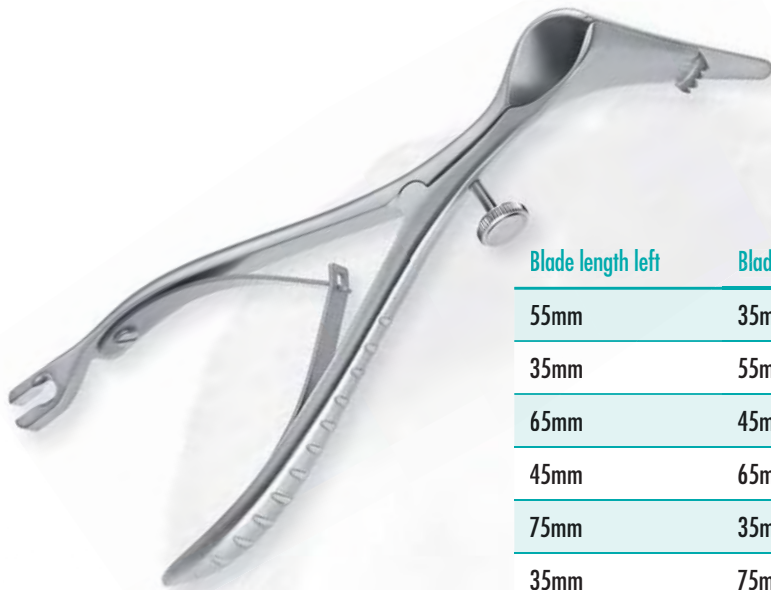

Sinus
Nasal Speculum, with teeth,
aseptic joint, for flexible arm

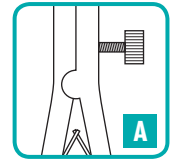

Blade length left	Blade length right	Total length	A - With locking screw
55mm	35mm	140mm	420-150-001
35mm	55mm	140mm	420-150-002
65mm	45mm	140mm	420-150-003
45mm	65mm	140mm	420-150-004
75mm	35mm	140mm	420-150-005
35mm	75mm	140mm	420-150-006
75mm	52mm	140mm	420-150-007
52mm	75mm	140mm	420-150-008
Flexible Arm complete with holding rod			251-010-000
Nasal Specula Clamp for Flexible Arm			251-010-400

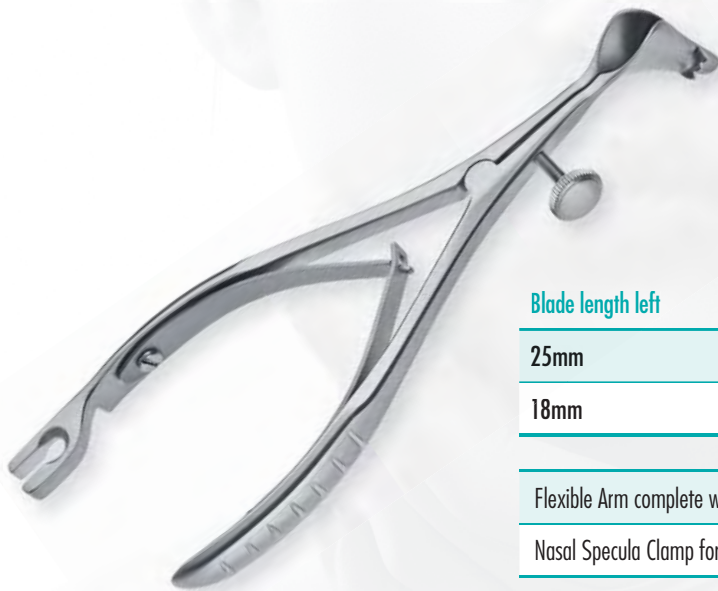

Sinus
Nasal Speculum, for children,
with teeth, aseptic joint,
for flexible arm

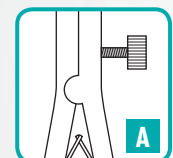

Blade length left	Blade length right	Total length	A - With locking screw
25mm	18mm	140mm	420-150-301
18mm	25mm	140mm	420-150-302
Flexible Arm complete with holding rod			251-010-000
Nasal Specula Clamp for Flexible Arm			251-010-400

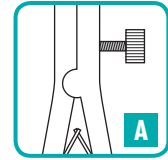
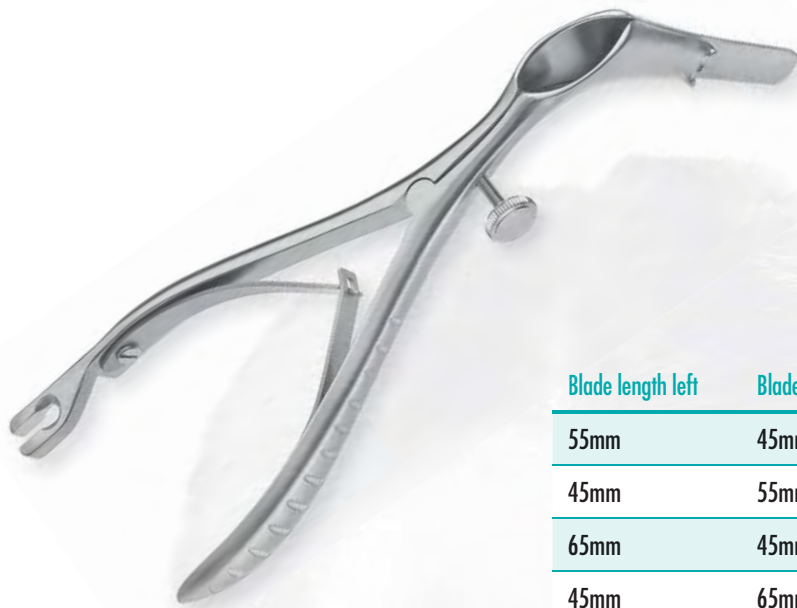

Killian-Struycken Sinus
Nasal Speculum, with teeth,
aseptic joint, for flexible arm

Blade length left	Blade length right	Total length	A - With locking screw
55mm	45mm	150mm	420-150-201
45mm	55mm	150mm	420-150-202
65mm	45mm	150mm	420-150-203
45mm	65mm	150mm	420-150-204
75mm	45mm	150mm	420-150-205
45mm	75mm	150mm	420-150-206

Flexible Arm complete with holding rod	251-010-000
Nasal Specula Clamp for Flexible Arm	251-010-400



Length of flexible arm 500mm

Flexible Arm complete with holding rod without Rotating Clamp

Flexible Arm 251-010-000

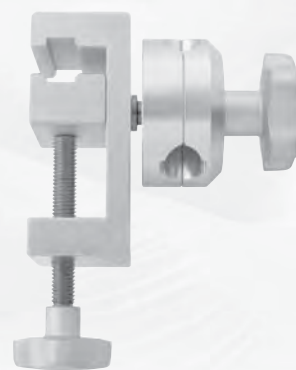

Rotating clamp for flexible tension arm attachable to operating table

Rotating Clamp 251-010-100



Nasal Specula Clamp for Flexible Arm

Nasal Specula Clamp 251-010-400



NASAL INSTRUMENTS





1:1

JOSEPH

Septum Raspatory, slightly curved, 170mm, 6²/₃"

2mm	420-530-165
3mm	420-531-165
4mm	420-532-165



1:1

JOSEPH

Periosteal Elevator, curved, 160mm, 6¹/₄"

4mm	420-585-160
-----	-------------



1:1

OBWEGESER

Periosteal Elevator, curved, 175mm, 6⁵/₈"

6mm	431-630-006
7mm	431-630-007
9mm	431-630-009
11mm	431-630-011



1:1

WARD

Periosteal Elevator, curved rand blade, 170mm, 6³/₄"

5.5mm	420-553-170
-------	-------------

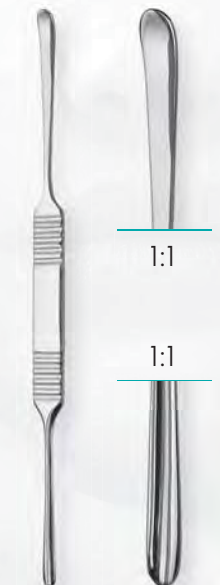

1:1

1:1

READ

Elevator, double-ended, blunt

215mm, 8 ¹ / ₂ "	420-481-215
--	-------------

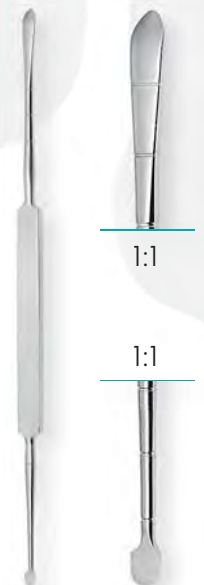

1:1

1:1

COTTLE

Elevator, double-ended, graduated, sharp/blunt

210mm, 8 ¹ / ₄ "	420-550-230
--	-------------



NASAL INSTRUMENTS

Elevator

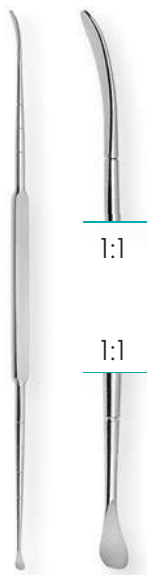

1:1

1:1

MASING

Septum Elevator, double-ended, graduated, sharp/blunt

200mm, 8"

420-551-200

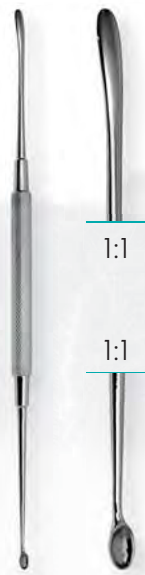

1:1

1:1

CARTER

Septum Elevator, double-ended

210mm, 8¹/₄"

420-551-210

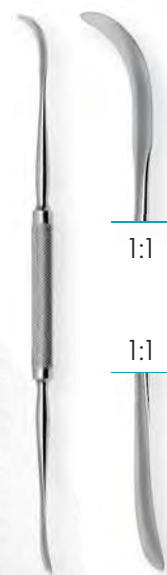

1:1

1:1

OBWEGESER-FREER

Septum Elevator

200mm, 8"

420-532-200



1:1

GOLDMANN

Septum elevator, round, for straightening the nose

200mm, 8"

420-189-210



1:1

BOIES

Elevator for Septum Repositioning

170mm, 6³/₄"

420-557-170



1:1

BOIES

Nasal Fracture Elevator, 9mm

195mm, 7³/₄"

420-555-195





LAMONT

Raspatory, strongly curved, sharp, 170mm, 6²/₃"

3mm	430-531-170
-----	-------------

6mm	430-532-170
-----	-------------

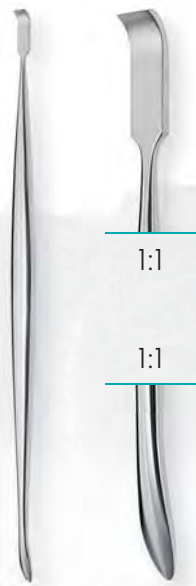

HOWARTH

Elevator, double-ended, sharp/blunt

215mm, 8 ¹ / ₂ "	420-552-215
--	-------------



JOSEPH

Nasal Saw, 170mm, 6³/₄"

Straight	230-202-000
----------	-------------

Bayonet, curved right	230-202-001
-----------------------	-------------

Bayonet, curved left	230-202-002
----------------------	-------------

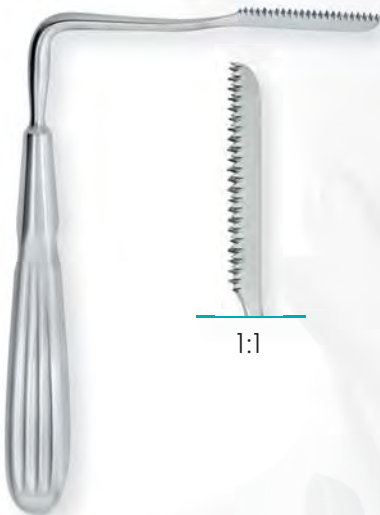

JOSEPH

Nasal Saw, 170mm, 6³/₄"

Right-angled	230-210-170
--------------	-------------

Left-angled	230-211-170
-------------	-------------

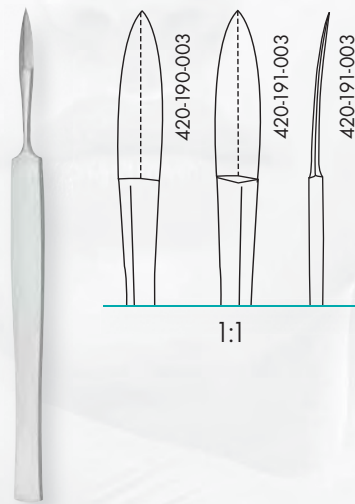

JOSEPH

Nasal Knife, double-edge, sharp, 150mm, 6"

Straight	420-190-003
----------	-------------

Curved	420-191-003
--------	-------------

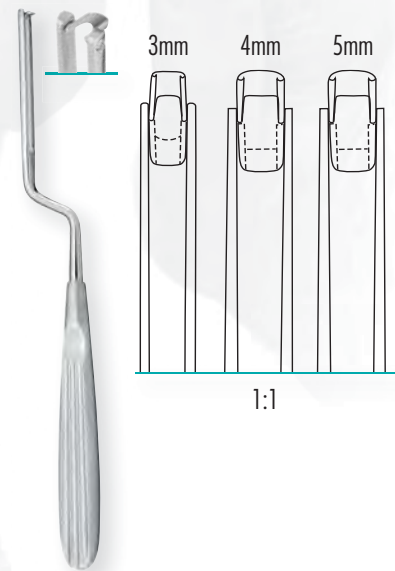

BALLENGER

Swivel Knife, bayonet shaped, 210mm, 8¹/₄"

3mm	420-392-003
-----	-------------

4mm	420-392-004
-----	-------------

5mm	420-392-005
-----	-------------



NASAL INSTRUMENTS

Septum Straightening Forceps,
Morselizers & Bone Rongeurs



1:1

COTTLE-WALSHAM

Septum Straightening Forceps, aseptic lock, 230mm, 9"

Straight	420-450-230
Left	420-451-230
Right	420-452-230



1:1

ASH

Septum Straightening Forceps, 8³/₄"

220mm, 8 ³ / ₄ "	420-455-230
--	-------------



1:1

GUNTER

TC Lower Lateral Morselizer

180mm, 7"	420-220-212
-----------	-------------

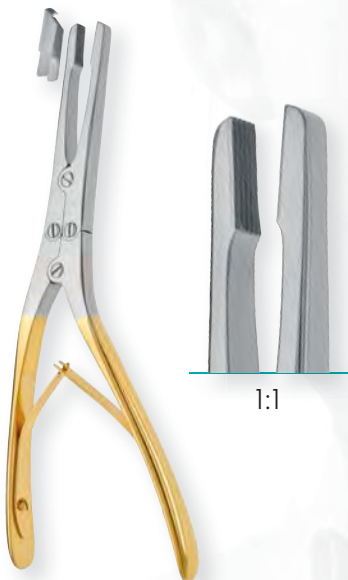

1:1

GORNEY

Septal Morselizer, double action, angled, incl. guard

200mm, 8"	420-220-220
-----------	-------------

Guard, only

1 piece	420-221-200
---------	-------------

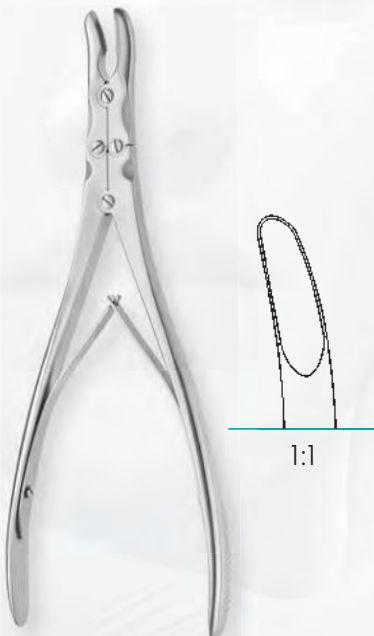

1:1

RÖTTGEN-RUSKIN

Bone Rongeur, curved, 5mm, double action

240mm, 9 ¹ / ₂ "	210-792-230
--	-------------

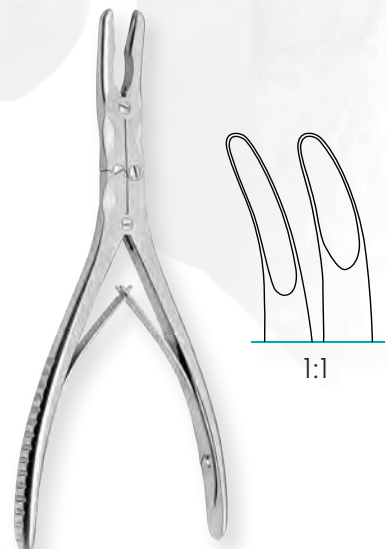

1:1

BEYER

Bone Rongeur, curved, double action, 180mm, 7"

4mm	210-790-180
-----	-------------

More Rongeurs in our comprehensive ORTHOPAEDICS catalogue.



RZ
Medizintechnik
GmbH

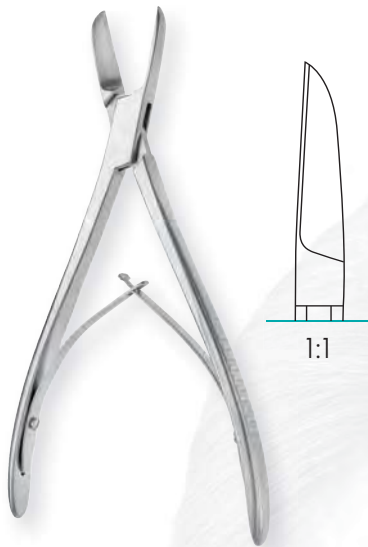

COTTLE-KAZANJIAN
Bone Cutting Forceps, for removal of nasal hump

180mm, 7"

210-845-185



RUSKIN-LISTON
Bone Cutting Forceps, straight

170mm, 6²/₃"

210-844-170

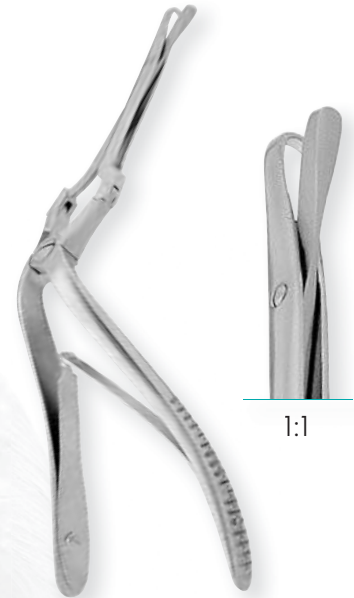

JANSEN-MIDDLETON
Nasal Forceps, through cutting, 4x14mm, 8¹/₄"

210mm, 8¹/₄"

252-031-190



JANSEN-MIDDLETON
Nasal Forceps, 4x11mm, Spoon Jaw

170mm, 6³/₄"

252-032-190



LANGENBECK
Bone Holding Forceps

210mm, 8¹/₂"

210-722-210



DINGMANN
Bone Holding Forceps

190mm, 7¹/₄"

210-626-190



NASAL INSTRUMENTS

Bone / Cartilage
Crushers & Accessories



COTTLE
Bone Crusher, complete with clamp

28mm 420-365-000

For preparation of bone graft material.



RZ
Cartilage Crusher

60 x 30mm 420-364-000



Plastic Plate, autoclavable, 85x55mm, 3 x 2"

85x55mm, 3x2" 420-367-000

For preparation of bone grafts.



TOLSDORF
Bone Crusher

40mm, 7" 420-366-000

Inner Diameter



Without fibre-optic

MALINIAC
Nasal Retractor, 9x45mm, 100mm, 4"

Without fibre-optic	420-652-100
With fibre-optic (light carrier)	420-752-100



CONVERSE
Nasal Retractor, 11x44mm

110mm, 4 ¹ / ₃ "	420-235-110
--	-------------



CONVERSE
Nasal Retractor, fibre-optic light carrier, 11x44mm

110mm, 4 ¹ / ₃ "	420-236-110
--	-------------



CONVERSE
Nasal Retractor, 90mm, 3¹/₂"

10x20mm	420-237-095
12x30mm	420-238-095
12x40mm	420-239-090
12x50mm	420-239-095



CONVERSE
Nasal Retractor, fibre-optic light carrier, 90mm, 3¹/₂"

10x20mm	420-237-195
12x30mm	420-238-195
12x40mm	420-239-190
12x50mm	420-239-195



DEVINE-MILLARD-AUFRICHT
Nasal Retractor, fibre-optic light carrier, 10x45mm

180mm, 7"	420-257-160
-----------	-------------

For use with fibre-optic cables (see page 248).



NASAL INSTRUMENTS

Nasal Retractors



DEVINE-MILLARD-AUFRICHT

Nasal Retractor, 10x45mm

180mm, 7"

420-057-160



AUFRICHT

Nasal Retractor, 10x45mm

160mm, 6¹/₄"

420-250-160



AUFRICHT

Nasal Retractor, fibre-optic light carrier, 120°, 10x45mm

160mm, 6¹/₄"

420-255-160



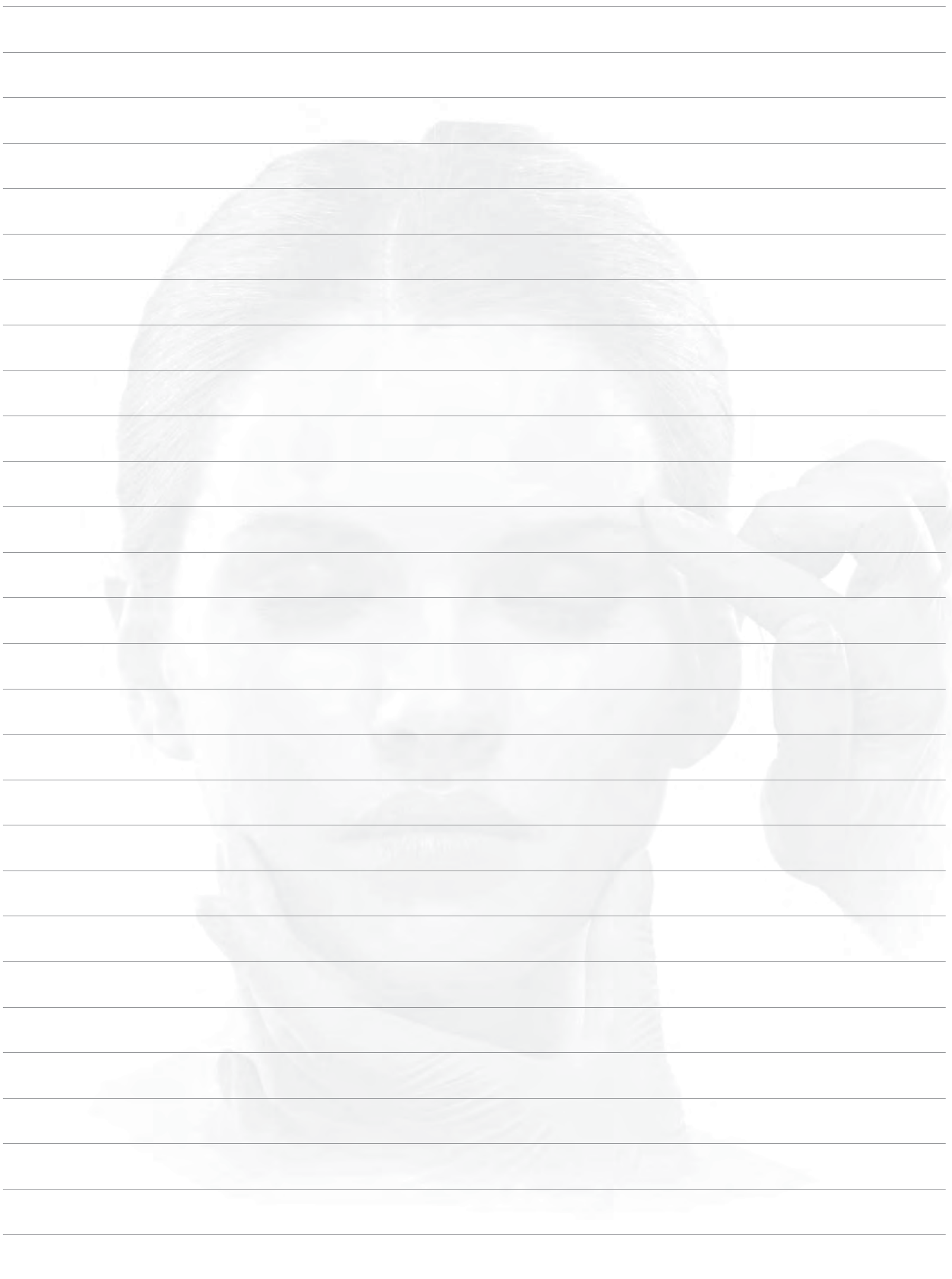



DERMATOLOGY INSTRUMENTS



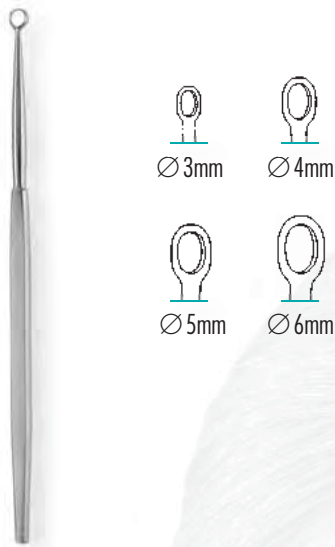

FOX
Lupus curette, round, 140mm, 5^{1/2}"

Ø 3mm	230-151-140
Ø 4mm	230-152-140
Ø 5mm	230-153-140
Ø 6mm	230-154-140

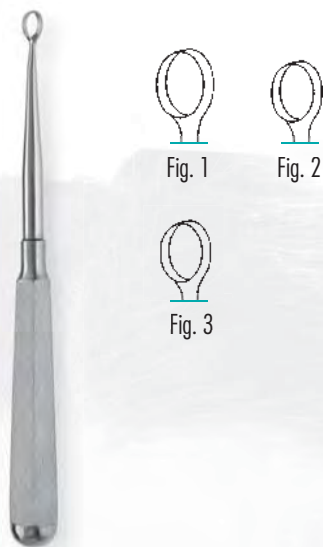

PIFFARD
Lupus curette, 140mm, 5^{1/2}"

Fig. 1	230-155-001
Fig. 2	230-155-002
Fig. 3	230-155-003

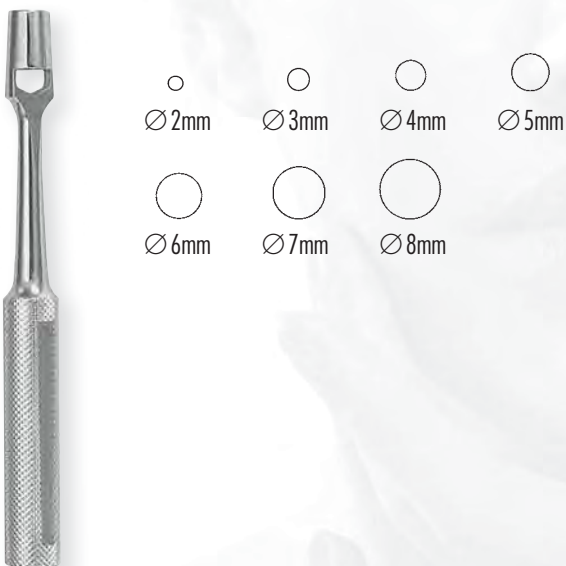

KEYES
Dermal punch, 120mm, 4^{3/4}"

Ø 2mm	230-160-002	Ø 6mm	230-160-006
Ø 3mm	230-160-003	Ø 7mm	230-160-007
Ø 4mm	230-160-004	Ø 8mm	230-160-008
Ø 5mm	230-160-005		

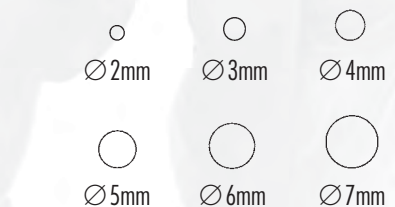

KEYES
Dermal punch set, 1 handle,

Full set	230-160-000
----------	-------------

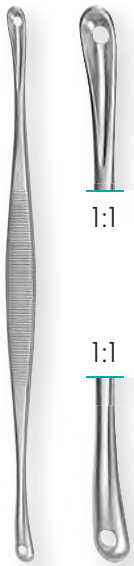

1:1

1:1

UNNA

Comedo Extractor, double-ended, oval cup

140mm, 5³/₄"

230-230-140

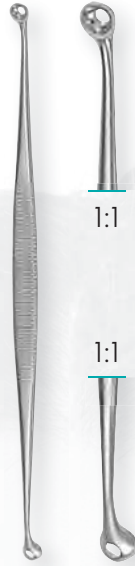

1:1

1:1

UNNA

Comedo Extractor, double-ended, round cup

140mm, 5³/₄"

230-232-140



1:1

1:1

SAALFELD

Comedo Extractor, double-ended

100mm, 4"

230-239-100

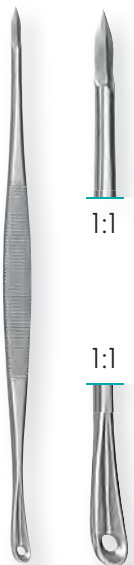

1:1

1:1

SAALFELD

Comedo Extractor, double-ended

140mm, 5³/₄"

230-236-140

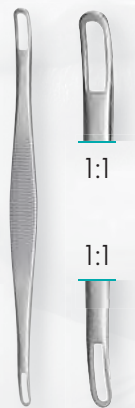

1:1

1:1

SCHAMBERG

Comedo Extractor, double-ended

100mm, 4"

230-238-100



1:1

1:1

WALTON

Comedone Extractor, double-ended

140mm, 5³/₄"

230-240-140

160mm, 6¹/₄"
(single ended)

503-003-000



1:1

LOCKE

Elevator, 110mm, 4¹/₃"

3x15mm blade

503-008-000

5x20mm blade

503-009-000

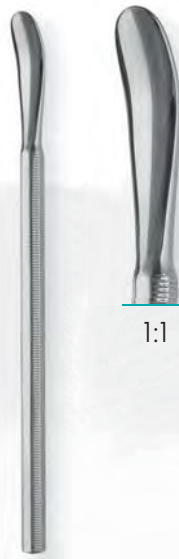

1:1

FROST

Elevator

130mm, 5"

503-011-000

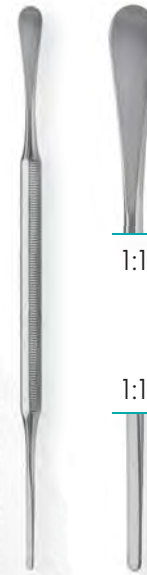

1:1

1:1

FROST

Spatula Packer, double-ended

135mm, 5¹/₃"

503-013-000



1:1

1:1

FROST

Probe-Excavator, double-ended

150mm, 6"

503-015-000



1:1

1:1

Curette, double-ended, with hole,
1.5mm/2mm, with 10mm handle

165mm, 6¹/₂"

503-022-015

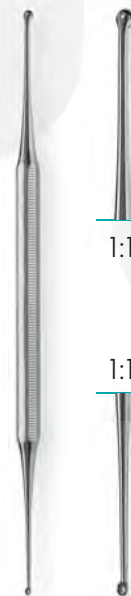

1:1

1:1

Curette excavator, double-ended,
with hole, 1.5mm / 2.5mm

140mm, 5¹/₂"

503-023-000

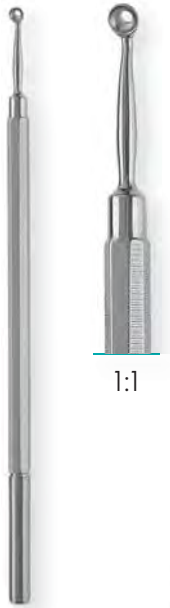

1:1

WALTON
Comedone Extractor

160mm, 6^{1/4}"

503-003-000



1:1

Nail Splitter, straight, large

150mm, 6"

503-005-000



1:1

Nail Splitter, angled, large

150mm, 6"

503-007-000



1:1

Scalpel Handle, 130mm, 5"

No. 3

110-110-003

No. 4

110-140-004



1:1

BARRON
Scalpel Handle

130mm, 5^{1/8}"

110-140-000



1:1

BALLENGER
Scalpel Handle

150mm, 6"

110-148-000





Nail Nipper

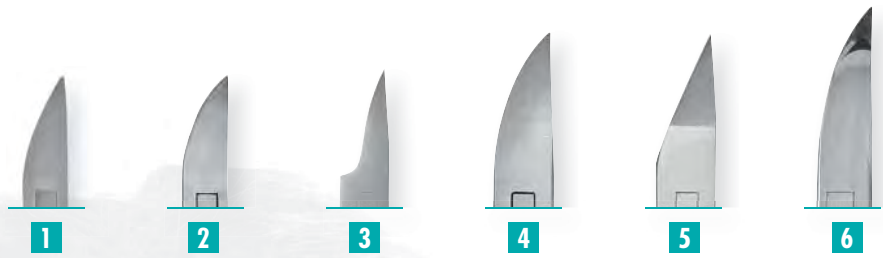

1	100mm, 4"	510-224-140	Straight jaws, double spring
2	110mm, 4 1/2"	510-225-140	Straight jaws, double spring
3	110mm, 4 1/2"	510-225-142	Delicate straight jaws, double spring
4	130mm, 5"	510-226-140	Straight jaws, double spring
5	130mm, 5"	510-226-142	Straight jaws, extra narrow, double spring
6	150mm, 6"	510-227-140	Straight jaws, double spring



Nail nipper, concave jaws

115mm, 4 1/2"

510-205-115



1:1

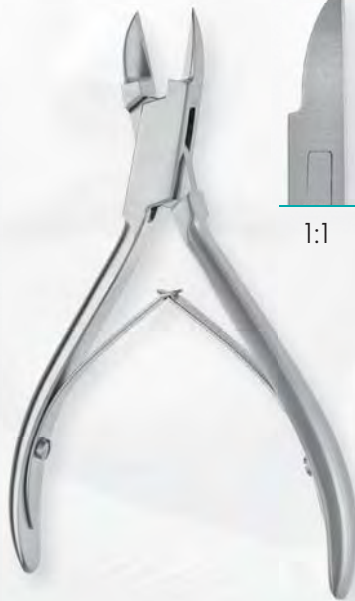

Nail nipper

130mm, 5"

510-347-130



1:1



Nail nipper concave, spring handle, with lock

150mm, 6"

510-332-150



Nail Nipper, double spring, 140mm, 5 1/2"

1	510-210-140
2	510-215-140



Nail Nipper, angled concave jaws, double spring

140mm, 5 1/2"	510-215-140
---------------	-------------



Mycotic Nail Nipper, straight, heavy duty jaws double action

150mm, 6"	510-377-160
-----------	-------------



Mycotic Nail Nipper, concave, heavy duty jaws, double action

150mm, 6"	510-338-150
-----------	-------------



Nail Nipper, concave, single spring

115mm, 4 1/2"	503-005-000
---------------	-------------



1:1

Cuticle and tissue nipper, convex jaws

110mm, 4 1/2"

510-250-110

130mm, 5"

510-251-130

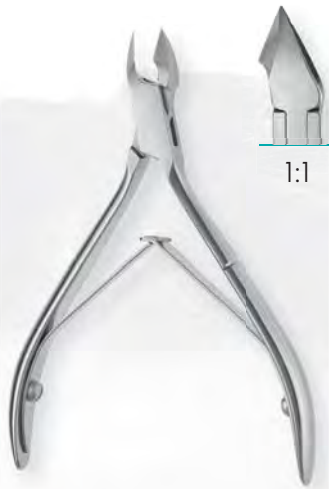

1:1

Cuticle and tissue nipper, convex jaws

100mm, 4"

510-245-100



1:1

Cuticle and tissue nipper, straight jaws, ring handle

100mm, 4"

510-220-100



1:1

RADOLF

Nail extraction forceps, narrow jaws

140mm, 5 1/2"

510-463-140



1:1

Nail extraction forceps

135mm, 5 1/3"

510-462-130



1:1

Nail extraction forceps, duck shaped jaws

140mm, 5 1/2"

510-464-140



Nail splitting forceps

135mm, 5³/₈"

510-334-140



Finger ring saw, with replaceable circular blade

170mm, 6²/₃"

210-975-170



Nail Scissors, curved

90mm, 3¹/₂"

510-425-090

1:1

Spare circular blade

1 piece

210-976-000

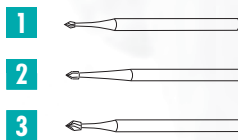

Finger drill only, 1 piece

1 510-460-001

2 510-460-002

3 510-460-003



Finger nail drill complete with 3 drill points

170mm, 6²/₃"

510-460-000



Nail rasp

100mm, 4"

510-050-100

120mm, 4³/₄"

510-050-120



1:1

FOERSTER
Capsulotomy Knife

270mm, 10^{2/3}"

260-310-270

For separation of spherical contracture during open capsulotomy. When used in an intramammary incision, the dull edge of the knife safely runs along the implant while fibrous tissue is dissected.



1:1

FREER
Mucosa Knife

150mm, 6"

420-195-150



1:1

JOSEPH
Button-end Knife, straight

150mm, 5^{1/2}"

420-205-160

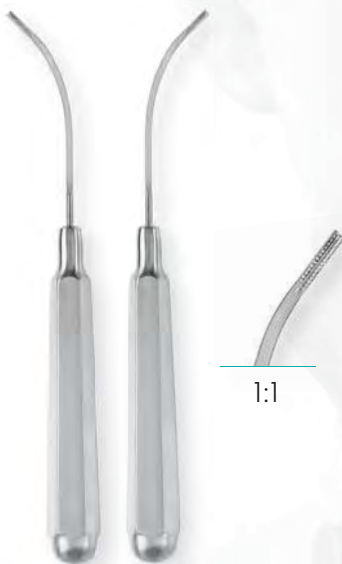

1:1

DINGMAN
Otopraders, set of left and right pattern

160mm, 6^{1/4}"

410-033-100

For cutting inner ear cartilage during otoplasty.



1:1

STENSTRØM
Ear Scraper, 160mm, 6^{1/4}"

Curved left

410-033-130

Curved right

410-033-131



1:1

STENSTRØM
Ear Rasp, 160mm, 6^{1/4}"

Curved left

410-033-132

Curved right

410-033-133



GOULIAN

Hand Dermatome, 3 templates (0.2/0.25/0.3mm)

190mm, 7¹/₂"

110-096-180

Spare blades, non-sterile

5 pieces

110-096-185



BRAITHWAITE (MODIF. HUMBY)

Hand Dermatome, complete, 305mm, 12"

Left handed

110-097-305

Right handed

110-098-305

Spare blades, non-sterile

10 pieces

110-098-399



SCHINK

Dermatome, exchangeable blade, 2 straightening blades

305mm, 12"

110-090-000

Spare blade

1 piece

110-090-001



SILVER

Skin Graft Knife

190mm, 7¹/₂"

110-096-019

Spare blade

1 piece

110-096-119



Skin Graft Board
bevelled edge

200x100mm

110-090-150



GABBARO

Skin Graft Measure

110-090-100



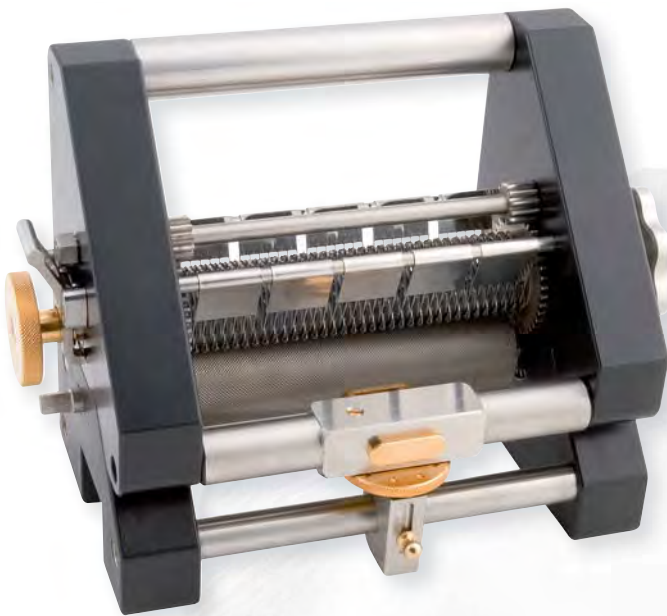

Order number

110-355-000

Description

ROSENBERG Skin Graft Mesher, with crank handle 110-355-200

Advantages

- Entire range of meshing ratios in a single mesher
- Eliminates the need to stock different skin graft carriers
- Accommodates skin grafts of any size and shape

Skin graft meshers are designed to incise and “mesh” a skin graft in order to allow it to expand and cover an area larger than its donor site, to conform to an irregular recipient site, or to drain exudates or blood. The skin graft may be meshed into several meshing ratios according to the graft size needed, available skin, and functional and aesthetic considerations. Different meshing devices and systems are commercially available, each with its specific carrier. In order to cover the entire range of meshing ratios, a number of “meshing systems” that include different ratio meshing devices have to be available, each requiring their own specific carriers. The length and width of the meshed skin graft is limited by the available carrier’s dimensions, usually less than 75x200mm. The meshing action is performed by cranking a long ratchet or a crank that may interfere with the fine control of the extruded skin graft and demands a rather strenuous exertion by the nurse and the surgeon.

The mesher width is nearly double the width of traditional meshers and the practically unlimited length of the carrier allows for meshing grafts of any size and shape. Compared to the smaller “Zimmer”-carrier the new standard-carrier is generously sized with 140x300mm. The unique elevation system offers the option of increasing the pressure on the carrier. The elevation system also allows any smooth plate (thickness range from 0.5mm to 5mm, 140mm wide and unlimited length). The smooth carrier and a releasing net prevent the meshed skin graft from adhering to the cutting blades.

The wide mesher and the specially designed blades cut Integra® without crushing it.

The mesher can be opened for cleaning and maintenance.

Conclusions:

The new adjustable mesher offers the entire range of meshing ratios in a single mesher, eliminates the need to stock different skin graft carriers and accommodates skin grafts of any size and shape.

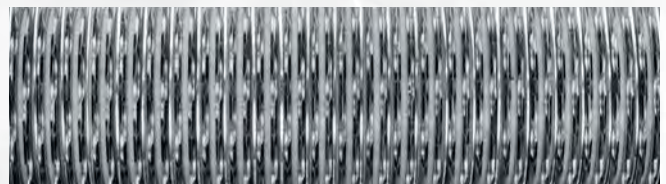

Narrow blades of a traditional power dermatome that limit the width of the meshed skin graft (compared to the much wider manual dermatome).



A single mesher with a unique adjustable drum that allows for meshing over the entire range of meshing ratios, from 1:1 up to more than 1:5.

A) 1:1 mesh ratio, B) 1:2.5 mesh ratio, and C) 1:5 mesh ratio.



A ready-to-use
Skin Graft Mesher



ROSENBERG
Transplant carrier, 140 x 300mm

20 pieces

110-355-100



1/2 Sterilization Container, Safety Model
285 x 280 x 260mm

Grey lid

600-279-261



ROSENBERG
Spare crank handle

1 piece

110-355-200



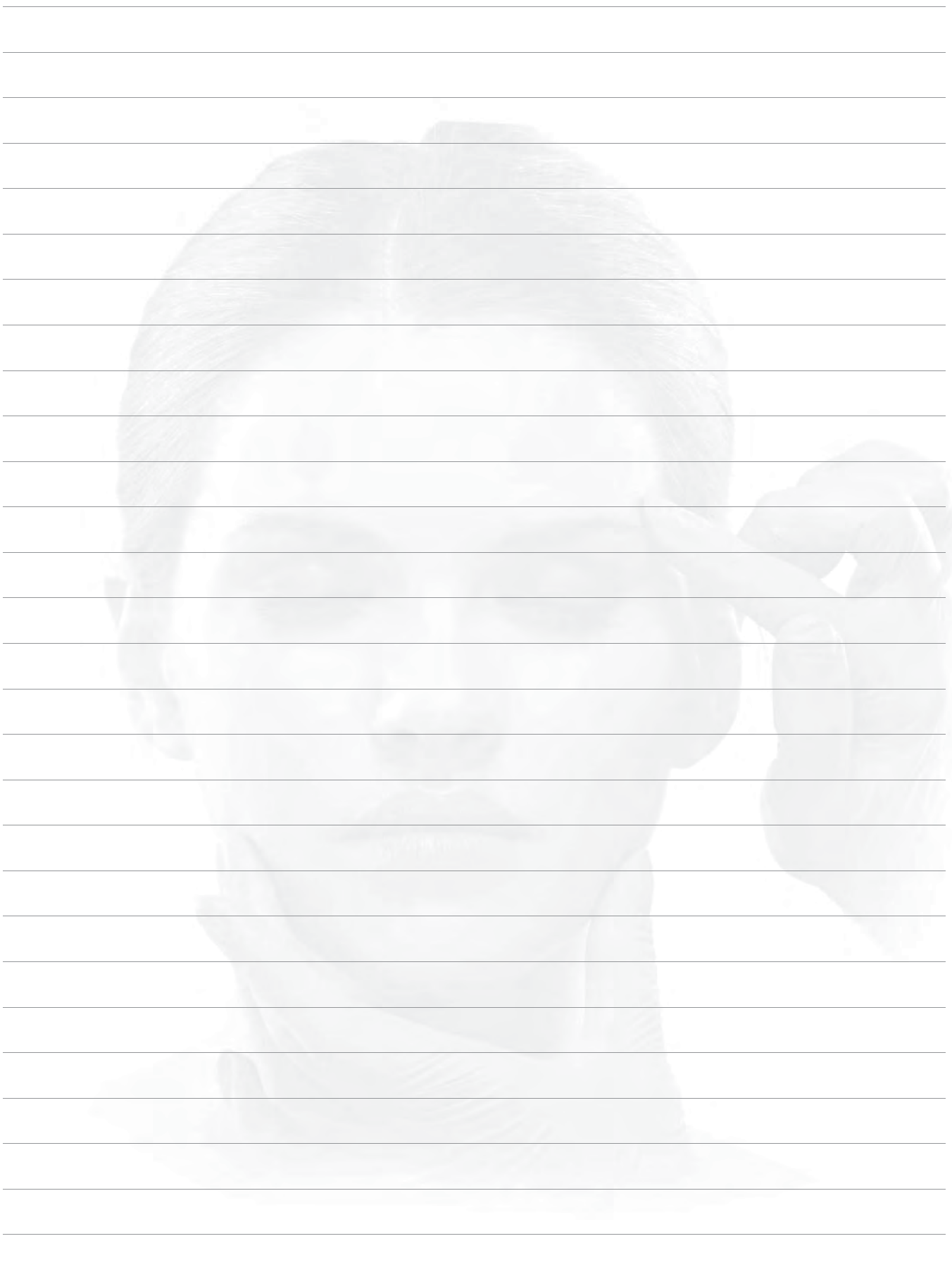



CLEFT PALATE INSTRUMENTS



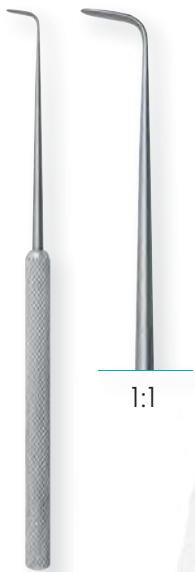

1:1

CRONIN

Cleft Palate Elevator, 180mm, 7"

Large	430-100-600
Medium	430-100-601
Small	430-100-602



1:1

BLAIR

Cleft Palate Elevator, right-angled, blunt

180mm, 7"	430-105-002
-----------	-------------



1:1

BLAIR

Cleft Palate Elevator, flat, blunt

200mm, 8"	430-105-003
-----------	-------------



1:1

BLAIR

Cleft Palate Elevator, L-Shaped, blunt, rounded

180mm, 7"	430-105-001
-----------	-------------

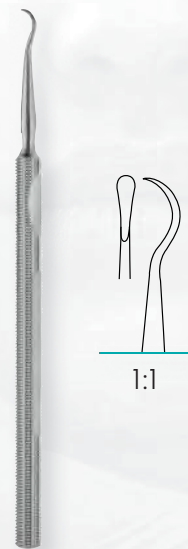

1:1

JABOMA

Cleft Palate Periosteal Elevator

170mm, 6 ³ / ₄ "	431-200-100
--	-------------



1:1

CRONIN

Cleft Palate Knife, 180mm, 7"

Triangular	430-100-603
Rectangular	430-100-604

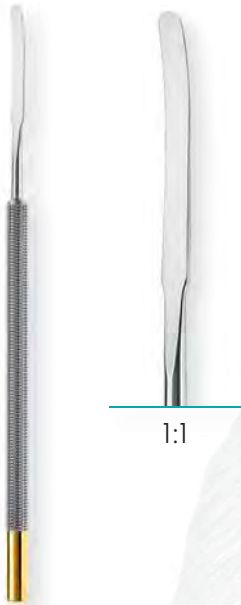

1:1

SALYER
Cleft Palate Elevator, 180mm, 7"

Slightly curved	431-200-021
Curved	431-200-023

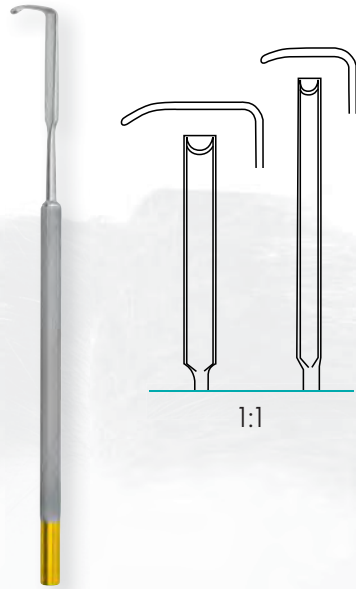

1:1

SALYER
Cleft Palate Hooklet, 180mm, 7"

Short blade	431-200-001
Long blade	431-200-003

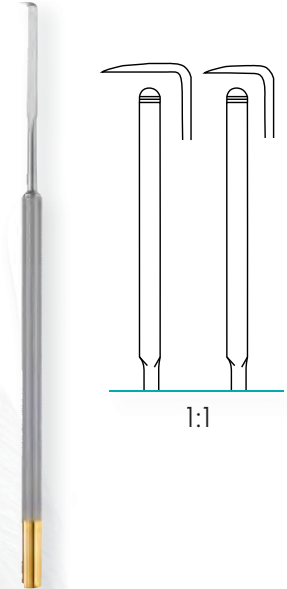

1:1

SALYER
Cleft Palate Dissector, 180mm, 7"

Short blade	431-200-011
Long blade	431-200-013

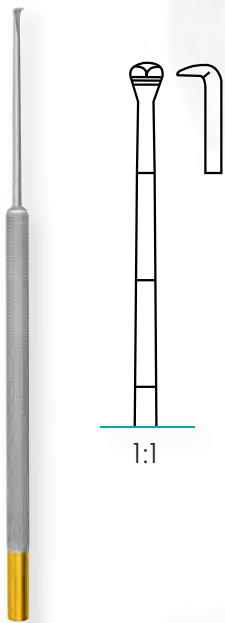

1:1

SALYER
Cleft Palate Elevator, triangular blade, 180mm, 7"

Triangular blade	431-200-027
------------------	-------------



1:1

Cleft Palate Raspatory, 140mm, 5¹/₂"

Curv. upwards	420-580-145
Curv. downwards	420-583-145

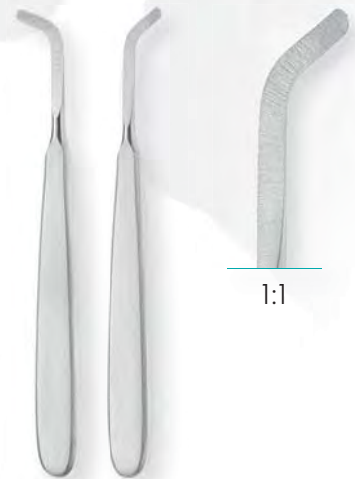

1:1

Cleft Palate Raspatory, 140mm, 5¹/₂"

Curv. upwards, right	420-581-140
Curv. upwards, left	420-582-140



Logan Bow, with teeth

28mm / 1 ¹ / ₈ " wide	420-985-013
32mm / 1 ¹ / ₄ " wide	420-985-014
35mm / 1 ¹ / ₃ " wide	420-985-015

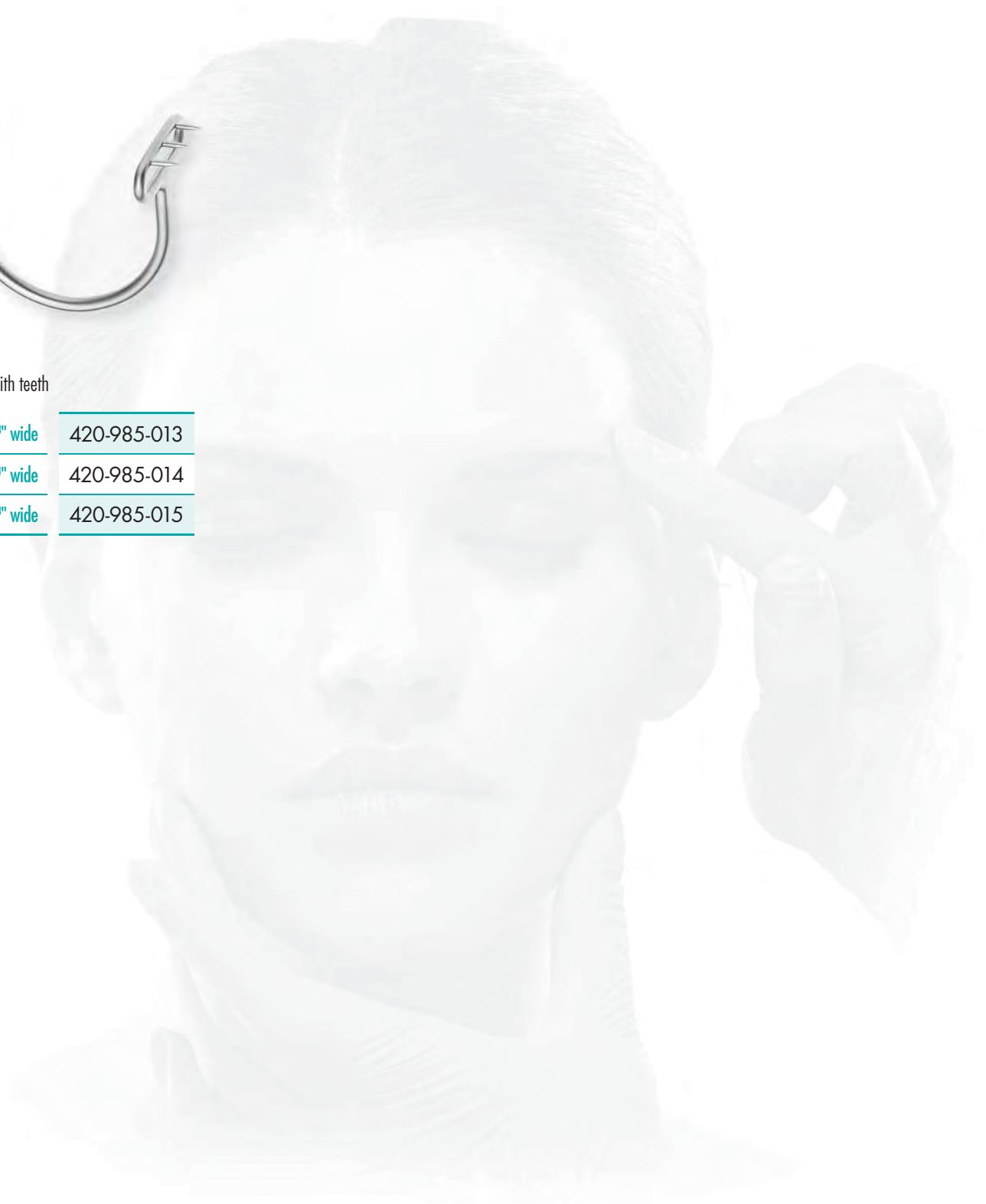



SHAPERS





SHAPER Sheath with one rotating stopcock, with angled spatula tip for the best view during tissue dissection

Ø 4 mm	260-501-180
Ø 5 mm	260-501-185



SHAPER Sheath for plastic telescopes with one rotating stopcock, with large angled up spatula tip for the best view during tissue dissection

Ø 4 mm	260-502-180
Ø 5 mm	260-502-185



SHAPER Sheath for plastic Endoscopy, with one rotating stopcock, with a flat spatula tip

Ø 4 mm	251-140-175
Ø 5 mm	251-150-175



SHAPER Sheath for plastic telescopes, with two rotating stopcocks, with a flat spatula tip

Ø 4 mm	251-340-175
Ø 5 mm	251-345-175



SHAPER Telescope for Plastic Endoscopy, 30°, Wide Angle, autoclavable, for use with all SHAPER Sheaths

Ø 4 mm	260-104-030
Ø 5 mm	260-105-030

SHAPER Dissectors are designed to fit facial contours. The large number of different dissectors enables the application under any anatomical conditions.

The well balanced instruments with their special handle design provide a secure grip and ensure precise and untiring working during long surgeries.

1:1

SHAPER Scalp Elevator, slightly curved, 12.5mm wide, 240mm, 9¹/₂"

260-001-001

With Ergo Handle

260-001-101

With Ergo Handle, malleable

260-001-201

1:1

SHAPER Scalp Elevator, half curved, with angled tip, 12.5mm wide, 240mm, 9¹/₂"

260-001-002

With Ergo Handle

260-001-102

With Ergo Handle, malleable

260-001-202

1:1

SHAPER Dissector, half curved, 7.0mm wide, 240mm, 9¹/₂"

260-002-001

With Ergo Handle

260-002-101

With Ergo Handle, malleable

260-002-201

1:1

SHAPER Transoral Dissector, curved, 7.0mm wide, 235mm, 9¹/₄"

260-007-001

With Ergo Handle

260-007-101

With Ergo Handle, malleable

260-007-201

1:1

SHAPER Scalp Elevator, straight,
7.0mm wide, 240mm, 9¹/₂"

260-002-003

With Ergo Handle

260-002-103

With Ergo Handle, malleable

260-002-203

1:1

SHAPER Frontotemporal Dissector, curved,
6.5mm wide, 240mm, 9¹/₂"

260-020-001

With Ergo Handle

260-020-101

With Ergo Handle, malleable

260-020-201

1:1

SHAPER Frontoglabellar Dissector,
s-shaped, 265mm, 10¹/₂"

260-023-000

With Ergo Handle

260-023-100

With Ergo Handle, malleable

260-023-200

1:1

SHAPER Arcus Marginalis Dissector,
s-shaped, 240mm, 9¹/₂"

260-024-000

With Ergo Handle

260-024-100

With Ergo Handle, malleable

260-024-200



SHAPERS

Elevators & Dissectors



1:1

SHAPER Frontotemporal Dissector, straight, 10mm wide, 225mm, 8³/₄"

260-020-000

With Ergo Handle

260-020-100

With Ergo Handle, malleable

260-020-200



1:1

SHAPER Periosteal Dissector, s-shaped, 5mm wide, 240mm, 9¹/₂"

260-025-000

With Ergo Handle

260-025-100

With Ergo Handle, malleable

260-025-200



1:1

SHAPER Nerve Dissector, slightly curved, 240mm, 9¹/₂"

260-003-001

With Ergo Handle

260-003-101

With Ergo Handle, malleable

260-003-201



1:1

SHAPER Orbital Rim Dissector, half curved, 240mm, 9¹/₂"

260-004-001

With Ergo Handle

260-004-101

With Ergo Handle, malleable

260-004-201





SHAPER Temporal Dissector, straight,
235mm, 9¹/₄"

260-022-000

With Ergo Handle

260-022-100

With Ergo Handle, malleable

260-022-200

SHAPER Periosteal Dissector, curved,
250mm, 10"

260-021-000

With Ergo Handle

260-021-100

With Ergo Handle, malleable

260-021-200



SHAPER-Mini, Endoforehead Elevator,
half curved, with Ergo handle

250mm, 10"

260-202-101

SHAPER-Mini, Endoforehead Elevator, slightly
curved, with Ergo handle

275mm, 11"

260-202-103

SHAPER-Mini, Endoforehead Dissector,
full curved, with Ergo handle

285mm, 11¹/₄"

260-202-105



1:1

RAMIREZ
Flap Dissector, straight, Ergo handle

250mm, 10"

260-026-100

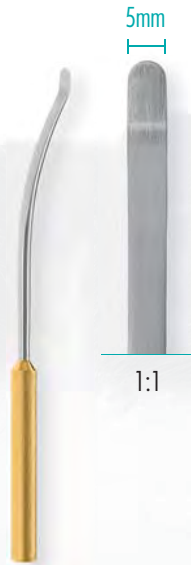

5mm

1:1

RAMIREZ
Endoforehead Corrugator, Procerus Dissector, 5mm

195mm, 4²/₃"

260-008-005



7mm

1:1

RAMIREZ
Endoforehead Corrugator, Procerus Dissector, 7mm

195mm, 4²/₃"

260-008-007



1:1

Periosteal Elevator,
7mm wide, curved

235mm, 9¹/₄"

260-002-002



1:1

SHAPER Nerve Hook,
240mm, 9¹/₂"

Curved right

260-003-002

Curved left

260-003-003



1:1

SHAPER Nerve Hook,
malleable, with graduation

235mm, 9¹/₄"

260-014-230



1:1

SHAPER Nerve Protector,
curved right

170mm, 6³/₄"

260-008-003



1:1

SHAPER Nerve Protector,
curved left

170mm, 6³/₄"

260-008-002



1:1

Suction Elevator, medium curved,
8mm wide, round edge

260mm, 10¹/₄"

260-002-015



1:1

Suction Elevator, slightly curved,
8mm wide, round edge

260mm, 10¹/₃"

260-002-005



1:1

Scalpel Handle for blades Fig. 10-15,
angled downwards

230mm, 9"

260-006-001

SHAPER Grasping Forceps, long serrated jaws, insulated shaft, Ø 2.7mm, 5" working length

Straight	260-204-100
Right curved	260-204-200
Left curved	260-204-500

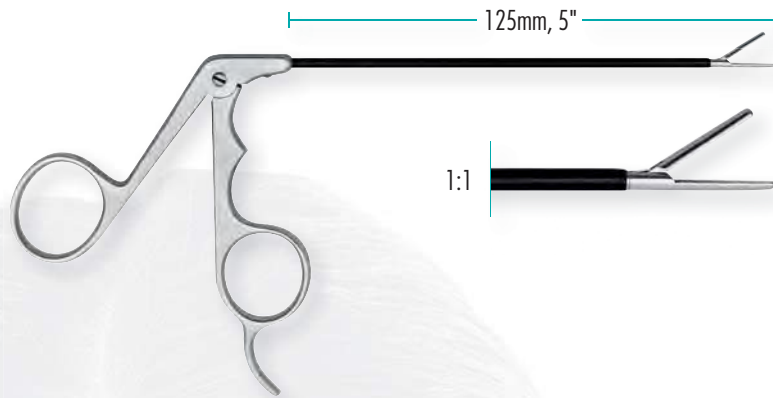

SHAPER Grasping Forceps, short strong jaws, insulated shaft, Ø 2.7mm, 5" working length

Straight	260-204-600
Right curved	260-204-400
Left curved	260-204-300

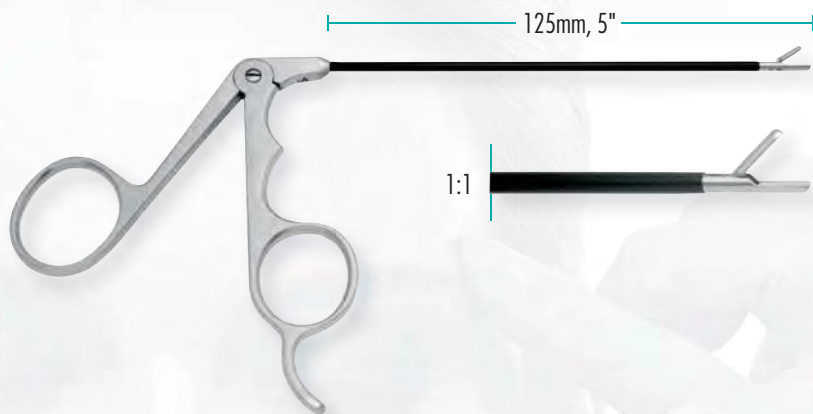

SHAPER Grasping Forceps, short jaws, aggressive teeth, insulated shaft, Ø 2.7 mm, 5" working length

Straight	260-204-627
Right curved	260-204-427
Left curved	260-204-327

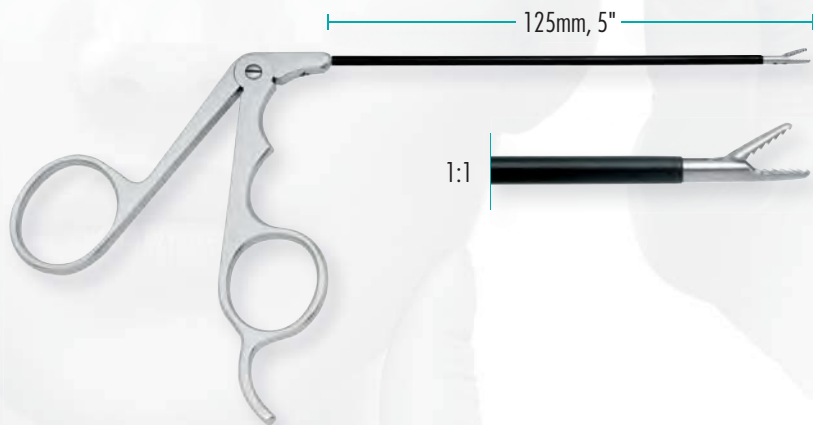

SHAPER Hook Scissors, insulated shaft, Ø 3.4mm, 5" working length

Straight	260-203-600
Right curved	260-203-700
Left curved	260-203-800

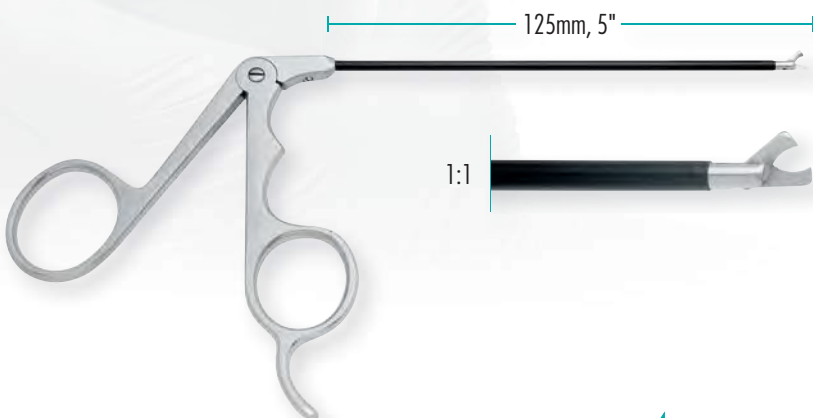

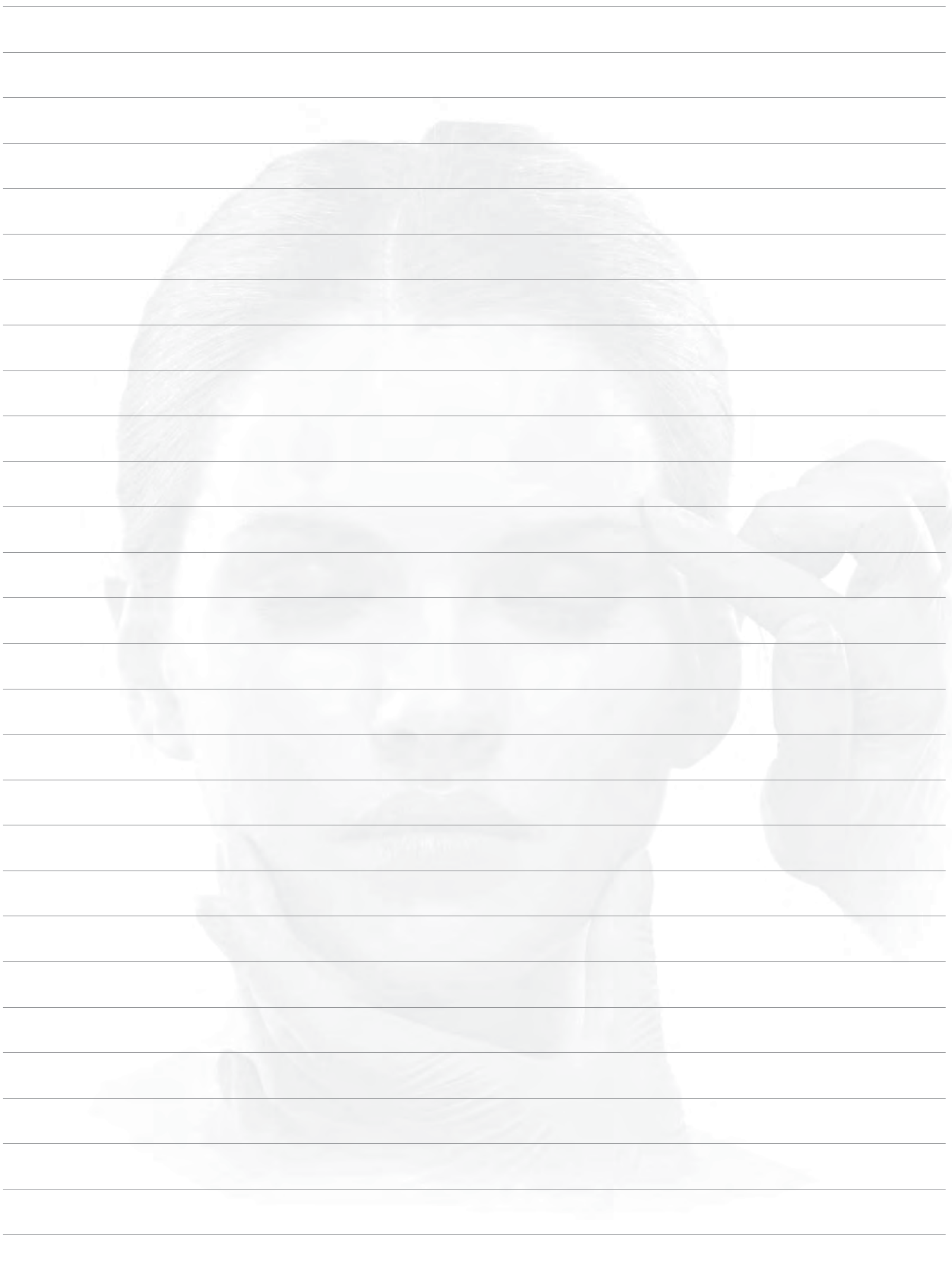



ENDOSCOPIC INSTRUMENTS





PEEK Polymer Laparoscopic Handle, for modular instrument inserts, gold plated HF-connection, rotatable

Without ratchet

300-750-101



PEEK Polymer Laparoscopic Handle, for modular instrument inserts, gold plated HF-connection, rotatable

With ratchet

300-750-103



PEEK Polymer Laparoscopic Handle, for modular instrument inserts, gold plated HF-connection, rotatable

With hook up ratchet

300-750-105



PEEK Polymer Laparoscopic Handle, for modular instrument inserts, gold plated HF-connection, rotatable

With swing ratchet

300-750-106

For use with a monopolar cable (see page 76).



ENDO FACELIFT INST.

Micro Inserts for Laparoscopic Handles



1:1

Micro Maryland Dissecting Forceps, curved shaft, rotating, insulated, insert

260-610-100



1:1

Micro Grasping Forceps, curved shaft, rotating, insulated, insert

260-604-100



1:1

Micro Grasping Forceps with alligator jaws, curved shaft, rotating, insulated, insert

260-608-100



1:1

Micro Hook Scissors, curved shaft, rotating, insulated, insert, single action

260-600-100



1:1

Micro Scissors, curved shaft, curved blades, rotating, insulated, insert, double action

260-614-100



1:1

Micro Scissors, curved shaft, rotating, insulated, straight blade, insert, double action

260-615-100

For use with a monopolar cable (see page 76).



Spatula Electrode, straight, with suction and trumpet valve

WL 270mm, 10¹/₃"

260-712-000



Spatula Electrode, curved, with suction and trumpet valve

WL 270mm, 10¹/₃"

260-702-000



J-Hook Electrode, straight, with suction and trumpet valve

WL 270mm, 10¹/₃"

260-710-000



J-Hook Electrode, curved, with suction and trumpet valve

WL 270mm, 10¹/₃"

260-700-000

For use with a monopolar cable (see page 76).



Assembling and disassembling the RZ electrode handle and inserts

- 1 Turn distal end of the handle clockwise until you can not turn it any longer

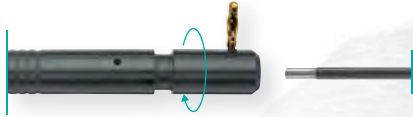

- 2 Insert the electrode into the handle until the metal part of the electrode is no longer visible



- 3 Turn distal end of the handle counter-clockwise



RZ Electrode Handle, monopolar connection, Luer Lock connector, no insert included

160mm, 10¹/₃"

260-700-100



1:1

Electrode insert for handle, straight shaft, angled tip, suction & monopolar connector

260-700-103



1:1

Electrode insert for handle, curved shaft, straight tip, suction & monopolar connector

260-700-105



1:1

Electrode insert for handle, suction & monopolar connector, straight tip, curved left shaft

260-700-102

curved right shaft

260-700-104



1:1

Electrode insert for handle, suction & monopolar connector, straight tip, curved right shaft

260-700-112

curved left shaft

260-700-114

For use with a monopolar cable (see page 76).

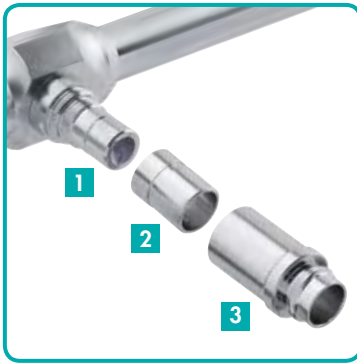

Universal light cable connector

- 1 RZ/Storz® connection
- 2 R. Wolf® connection
- 3 ACMI®/Gyrus® connection

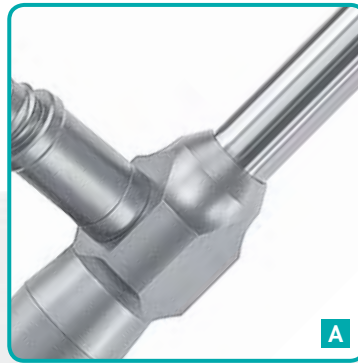

Standard fitting, e.g. 260-110-030

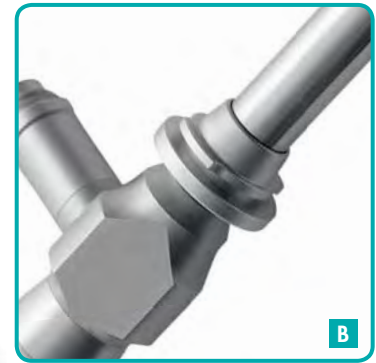

RZ scope connection, e.g. 260-110-033

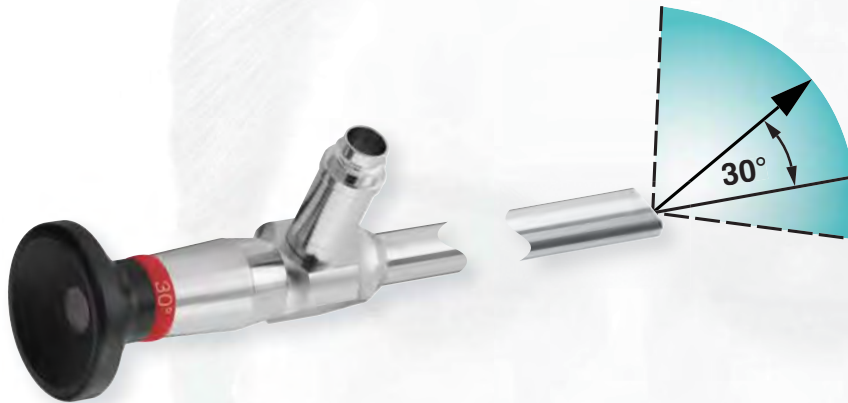

A Plastic Surgery Endoscope, 30°, Ø10mm

WL 175mm, 6 ^{3/4} "	260-110-030
------------------------------	-------------

B Same, with RZ scope connection

WL 175mm, 6 ^{3/4} "	260-110-033
------------------------------	-------------

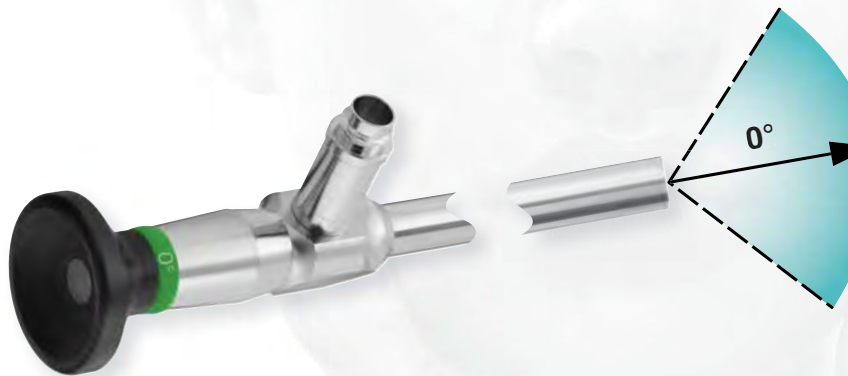

A Plastic Surgery Endoscope, 0°, Ø10mm

WL 175mm, 6 ^{3/4} "	260-110-000
------------------------------	-------------

B Same, with RZ scope connection

WL 175mm, 6 ^{3/4} "	260-110-003
------------------------------	-------------



A Plastic Surgery Endoscope, 30°, wide angle, 175mm, 6^{3/4}", autoclavable

Ø 4mm	260-104-030
-------	-------------

Ø 5mm	260-105-030
-------	-------------



RETRACTORS & DISSECTORS





Round and smooth blade

FERREIRA STYLE
Breast Retractor,
round and smooth blade

Blade size	Order number	Blade size	Order number
70x16mm	260-070-616	130x16mm	260-130-616
70x25mm	260-070-625	150x16mm	260-150-616
80x16mm	260-080-616	150x25mm	260-150-625
80x25mm	260-080-625	150x30mm	260-150-630
90x16mm	260-090-616	150x36mm	260-150-636
90x24mm	260-090-624	180x16mm	260-180-616
90x27mm	260-090-627	180x25mm	260-180-625
90x30mm	260-090-630	180x30mm	260-180-630
100x25mm	260-100-625	190x25mm	260-190-625
110x25mm	260-110-625	190x36mm	260-190-636
120x25mm	260-120-625	220x25mm	260-220-625



BREAST RETRACTORS

Ferreira Style
Breast Retractors



Round and smooth blade



Fibre-optic

FERREIRA STYLE

Breast Retractor, round and smooth blade, with fibre-optic

Blade size	Order number
70x16mm	260-070-016
70x25mm	260-070-025
80x16mm	260-080-016
80x25mm	260-080-025
90x16mm	260-090-016
90x24mm	260-090-024
90x27mm	260-090-027
90x30mm	260-090-030
100x25mm	260-100-025
110x25mm	260-111-025
120x25mm	260-120-025

Blade size	Order number
130x16mm	260-230-019
150x16mm	260-150-016
150x25mm	260-150-025
150x30mm	260-150-030
150x36mm	260-150-036
180x16mm	260-180-016
180x25mm	260-180-025
180x30mm	260-180-030
190x25mm	260-190-025
190x36mm	260-190-036
220x25mm	260-220-025



Round and smooth blade



Fibre-optic



Suction

FERREIRA STYLE

Breast Retractor, round and smooth blade,
with fibre-optic and suction

Blade size	Order number
70x16mm	260-070-116
70x25mm	260-070-125
80x16mm	260-080-116
80x25mm	260-080-125
90x16mm	260-090-116
90x24mm	260-090-124
90x27mm	260-090-127
90x30mm	260-090-130
100x25mm	260-100-125
110x25mm	260-110-125
120x25mm	260-120-125

Blade size	Order number
130x16mm	260-130-116
150x16mm	260-150-116
150x25mm	260-150-125
150x30mm	260-150-130
150x36mm	260-150-136
180x16mm	260-180-116
180x25mm	260-180-125
180x30mm	260-180-130
190x25mm	260-190-125
190x36mm	260-190-136
220x25mm	260-220-125



Silicone handle



Round and smooth blade



Fibre-optic

FERREIRA STYLE
Breast Retractor, silicone handle, round and smooth blade, with fibre-optic

Blade size	Order number
70x16mm	260-070-916
70x25mm	260-070-925
80x16mm	260-080-916
80x25mm	260-080-925
90x16mm	260-090-916
90x24mm	260-090-924
90x27mm	260-090-927
90x30mm	260-090-930
100x25mm	260-100-925
110x25mm	260-110-925
120x25mm	260-120-925

Blade size	Order number
130x16mm	260-130-916
150x16mm	260-150-916
150x25mm	260-150-925
150x30mm	260-150-930
150x36mm	260-150-936
180x16mm	260-180-916
180x25mm	260-180-925
180x30mm	260-180-930
190x25mm	260-190-925
190x36mm	260-190-936
220x25mm	260-220-925





Square toothed blade

TEBBET STYLE

Breast Retractor,
square and toothed blade

Blade size	Order number
70x16mm	260-070-716
70x25mm	260-070-725
80x16mm	260-080-716
80x25mm	260-080-725
90x16mm	260-090-716
90x24mm	260-090-724
90x27mm	260-090-727
90x30mm	260-090-730
100x25mm	260-100-725
110x25mm	260-110-725
120x25mm	260-120-725

Blade size	Order number
130x16mm	260-130-716
150x16mm	260-150-716
150x25mm	260-150-725
150x30mm	260-150-730
150x36mm	260-150-736
180x16mm	260-180-716
180x25mm	260-180-725
180x30mm	260-180-730
190x25mm	260-190-725
190x36mm	260-190-736
220x25mm	260-220-725



Square toothed blade



Fibre-optic

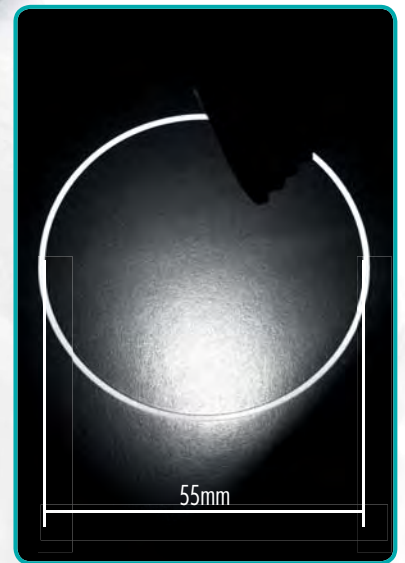

Tebbet Style Breast Retractor light intensity example

TEBBET STYLE
Breast Retractor, square and toothed blade, with fibre-optic

Blade size	Order number
70x16mm	260-070-216
70x25mm	260-070-225
80x16mm	260-080-216
80x25mm	260-080-225
90x16mm	260-090-216
90x24mm	260-090-224
90x27mm	260-090-227
90x30mm	260-090-230
100x25mm	260-100-225
110x25mm	260-110-225
120x25mm	260-120-225

Blade size	Order number
130x16mm	260-134-130
150x16mm	260-150-216
150x25mm	260-150-225
150x30mm	260-150-230
150x36mm	260-150-236
180x16mm	260-180-216
180x25mm	260-180-225
180x30mm	260-180-230
190x25mm	260-190-225
190x36mm	260-190-236
220x25mm	260-220-225



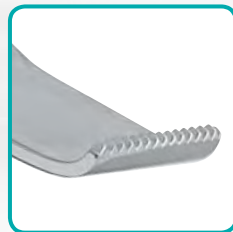

Square and toothed blade



Fibre-optic



Suction

TEBBET STYLE
Breast Retractor, square and toothed
blade, with fibre-optic and suction

Blade size	Order number
70x16mm	260-070-316
70x25mm	260-070-325
80x16mm	260-080-316
80x25mm	260-080-325
90x16mm	260-090-316
90x24mm	260-090-324
90x27mm	260-090-327
90x30mm	260-090-330
100x25mm	260-100-325
110x25mm	260-110-325
120x25mm	260-120-325

Blade size	Order number
130x16mm	260-130-316
150x16mm	260-150-316
150x25mm	260-150-325
150x30mm	260-150-330
150x36mm	260-150-336
180x16mm	260-180-316
180x25mm	260-180-325
180x30mm	260-180-330
190x25mm	260-190-325
190x36mm	260-190-336
220x25mm	260-220-325



Square and smooth blade

RZ TEBBET STYLE
Breast Retractor,
square and smooth blade

Blade size	Order number
70x16mm	260-070-816
70x25mm	260-070-825
80x16mm	260-080-816
80x25mm	260-080-825
90x16mm	260-090-816
90x24mm	260-090-824
90x27mm	260-090-827
90x30mm	260-090-830
100x25mm	260-100-825
110x25mm	260-110-825
120x25mm	260-120-825

Blade size	Order number
130x16mm	260-130-816
150x16mm	260-150-816
150x25mm	260-150-825
150x30mm	260-150-830
150x36mm	260-150-836
180x16mm	260-180-816
180x25mm	260-180-825
180x30mm	260-180-830
190x25mm	260-190-825
190x36mm	260-190-836
220x25mm	260-220-825





Square and smooth blade



Fibre-optic

RZ TEBBET STYLE
Breast Retractor, square and smooth blade, with fibre-optic

Blade size	Order number
70x16mm	260-070-416
70x25mm	260-070-425
80x16mm	260-080-416
80x25mm	260-080-425
90x16mm	260-090-416
90x24mm	260-090-425
90x27mm	260-090-427
90x30mm	260-090-430
100x25mm	260-100-425
110x25mm	260-110-425
120x25mm	260-120-425

Blade size	Order number
130x16mm	260-130-416
150x16mm	260-150-416
150x25mm	260-150-425
150x30mm	260-150-430
150x36mm	260-150-436
180x16mm	260-180-416
180x25mm	260-180-425
180x30mm	260-180-430
190x25mm	260-190-425
190x36mm	260-190-436
220x25mm	260-220-425



Square and smooth blade



Fibre-optic



Suction

RZ TEBBET STYLE

Breast Retractor, square and smooth blade, with fibre-optic and suction

Blade size	Order number
70x16mm	260-070-516
70x25mm	260-070-525
80x16mm	260-080-516
80x25mm	260-080-525
90x16mm	260-090-516
90x24mm	260-090-524
90x27mm	260-090-527
90x30mm	260-090-530
100x25mm	260-100-525
110x25mm	260-110-525
120x25mm	260-120-525

Blade size	Order number
130x16mm	260-130-516
150x16mm	260-150-516
150x25mm	260-150-525
150x30mm	260-150-530
150x36mm	260-150-536
180x16mm	260-180-516
180x25mm	260-180-525
180x30mm	260-180-530
190x25mm	260-190-525
190x36mm	260-190-536
220x25mm	260-220-525





	ROUND & SMOOTH BLADE			SQUARE & TOOTHED BLADE		
	Standard	Fibre-optic	Fibre-optic & suction	Standard	Fibre-optic	Fibre-optic & suction
70x16mm	260-070-616	260-070-016	260-070-116	260-070-716	260-070-216	260-070-316
70x25mm	260-070-625	260-070-025	260-070-125	260-070-725	260-070-225	260-070-325
80x16mm	260-080-616	260-080-016	260-080-116	260-080-716	260-080-216	260-080-316
80x25mm	260-080-625	260-080-025	260-080-125	260-080-725	260-080-225	260-080-325
90x16mm	260-090-616	260-090-016	260-090-116	260-090-716	260-090-216	260-090-316
90x24mm	260-090-624	260-090-024	260-090-124	260-090-724	260-090-224	260-090-324
90x27mm	260-090-627	260-090-027	260-090-127	260-090-727	260-090-227	260-090-327
90x30mm	260-090-630	260-090-030	260-090-130	260-090-730	260-090-230	260-090-330
100x25mm	260-100-625	260-100-025	260-100-125	260-100-725	260-100-225	260-100-325
110x25mm	260-110-625	260-111-025	260-110-125	260-110-725	260-110-225	260-110-325
120x25mm	260-120-625	260-120-025	260-120-125	260-120-725	260-120-225	260-120-325
130x16mm	260-130-616	260-230-019	260-130-116	260-130-716	260-134-130	260-130-316
150x16mm	260-150-616	260-150-016	260-150-116	260-150-716	260-150-216	260-150-316
150x25mm	260-150-625	260-150-025	260-150-125	260-150-725	260-150-225	260-150-325
150x30mm	260-150-630	260-150-030	260-150-130	260-150-730	260-150-230	260-150-330
150x36mm	260-150-636	260-150-036	260-150-136	260-150-736	260-150-236	260-150-336
180x16mm	260-180-616	260-180-016	260-180-116	260-180-716	260-180-216	260-180-316
180x25mm	260-180-625	260-180-025	260-180-125	260-180-725	260-180-225	260-180-325
180x30mm	260-180-630	260-180-030	260-180-130	260-180-730	260-180-230	260-180-330
190x25mm	260-190-625	260-190-025	260-190-125	260-190-725	260-190-225	260-190-325
190x36mm	260-190-636	260-190-036	260-190-136	260-190-736	260-190-236	260-190-336
220x25mm	260-220-625	260-220-025	260-220-125	260-220-725	260-220-225	260-220-325



RETRACTORS / DISSECTORS

Breast Retractor Order Matrix

	SQUARE & SMOOTH BLADE			SILICONE
	Standard	Fibre-optic	Fibre-optic & suction	Fibre-optic
70x16mm	260-070-816	260-070-416	260-070-516	260-070-916
70x25mm	260-070-825	260-070-425	260-070-525	260-070-925
80x16mm	260-080-816	260-080-416	260-080-516	260-080-916
80x25mm	260-080-825	260-080-425	260-080-525	260-080-925
90x16mm	260-090-816	260-090-416	260-090-516	260-090-916
90x24mm	260-090-824	260-090-424	260-090-524	260-090-924
90x27mm	260-090-827	260-090-427	260-090-527	260-090-927
90x30mm	260-090-830	260-090-430	260-090-530	260-090-930
100x25mm	260-100-825	260-100-425	260-100-525	260-100-925
110x25mm	260-110-825	260-110-425	260-110-525	260-110-925
120x25mm	260-120-825	260-120-425	260-120-525	260-120-925
130x16mm	260-130-816	260-130-416	260-130-516	260-130-916
150x16mm	260-150-816	260-150-416	260-150-516	260-150-916
150x25mm	260-150-825	260-150-425	260-150-525	260-150-925
150x30mm	260-150-830	260-150-430	260-150-530	260-150-930
150x36mm	260-150-836	260-150-436	260-150-536	260-150-936
180x16mm	260-180-816	260-180-416	260-180-516	260-180-916
180x25mm	260-180-825	260-180-425	260-180-525	260-180-925
180x30mm	260-180-830	260-180-430	260-180-530	260-180-930
190x25mm	260-190-825	260-190-425	260-190-525	260-190-925
190x36mm	260-190-836	260-190-436	260-190-536	260-190-936
220x25mm	260-220-825	260-220-425	260-220-525	260-220-925



Round and smooth blade
(Ferreira Style)



Square and toothed blade
(Tebbet Style)



Square and smooth blade
(RZ Tebbet Style)



Fibre-optic connection



Suction connection

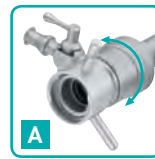

RZ scope connection

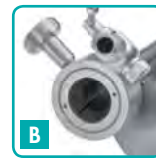

Universal scope connection



Smooth blade connection

Breast Optic Retractor, for \varnothing 10mm optic, with stopcock

Blade size	Connection	Scopes	Order number
180x16mm	A	\varnothing 4mm	260-130-160
180x25mm	A	\varnothing 4mm	260-130-000
180x25mm	B	\varnothing 10mm	260-130-015
180x25mm	A	\varnothing 10mm	260-130-016
180x25mm	A	\varnothing 5mm	260-130-014



DEAVER

Retractor with Silicone Handle, 35x300mm

With fibre-optic	260-293-300
With suction	260-135-300



Universal adaptor for fibre-optic retractors

1 piece	260-990-999
---------	-------------



A



reinforced version

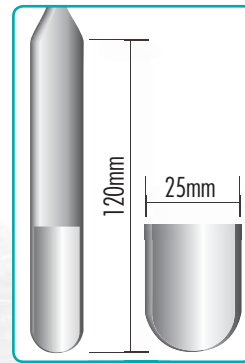

120x25mm blade

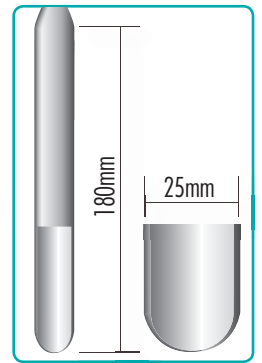

180x25mm blade

Mammary Retractor, solid blade, for \varnothing 10mm optic, with universal scope connection

Blade size	Order number
120x25mm	260-145-250
180x25mm	260-137-010



A

with locking screw to hold the telescope securely in place

with irrigation

with universal scope connection



reinforced version

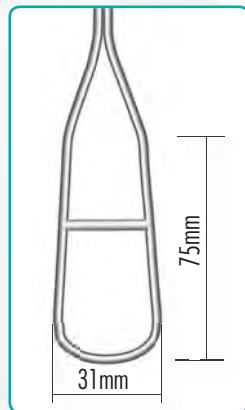

31mm blade

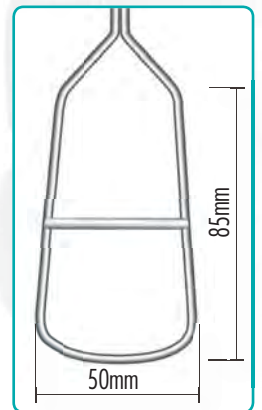

50mm blade

BIGGS

Mammary Retractor, fenestrated 31mm blade

Blade size	Order number
For 10mm scopes	260-135-000
For 4mm scopes	260-135-004
For 5mm scopes	260-135-005

Fenestrated 50mm blade

Blade size	Order number
For 10mm scopes	260-145-000



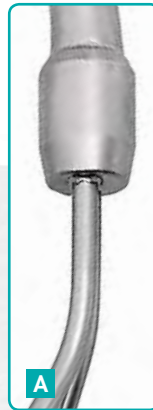

reinforced version

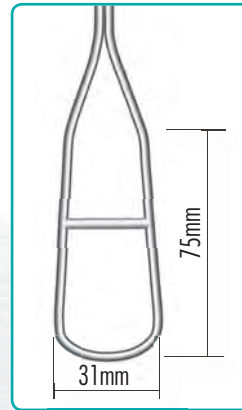

31mm blade

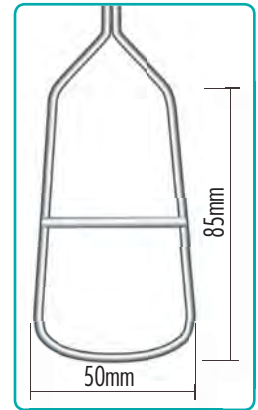

50mm blade

Mammary Retractor, fenestrated blade

Blade size	Order number
31mm	260-037-000
50mm	260-039-000



reinforced version

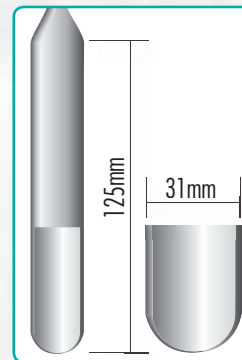

125x31mm blade

Mammary Retractor, fenestrated blade

Blade size	Order number
31mm	260-138-000



RETRACTORS / DISSECTORS

Breast & Facial Retractors



Breast and Facial Retractor, fenestrated blade, fine serration, 125mm, 5"

30mm blade	430-297-140
40mm blade	430-297-150



Breast and Facial Retractor, fenestrated blade, fine serration, **insulated**, 125mm, 5"

30mm blade	430-797-140
40mm blade	430-797-150



Breast and Facial Retractor with suction, fine serrations, 125mm, 5"

30mm blade	430-397-140
40mm blade	430-397-150



Breast and Facial Retractor, fenestrated blade, fine serration, fibre-optic, 125mm, 5"

30mm blade	430-497-141
40mm blade	430-497-151



Breast and Facial Retractor, fenestrated blade, fine serration, **insulated**, fibre-optic, 125mm, 5"

30mm blade	430-797-141
40mm blade	430-797-151

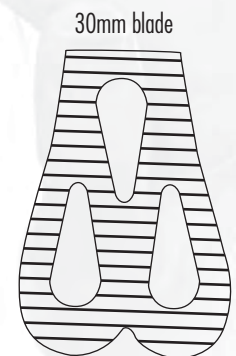

1:1

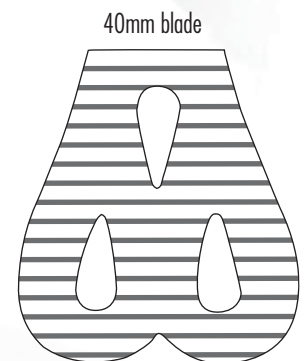

1:1





WIEDER
Breast & Facial Retractor, teeth, insulated, 140mm, 5^{1/2}"

40mm blade	430-797-155
------------	-------------



FERREIRA
Facelift Retractor, 155mm, 6^{1/8}"

110x20mm blade	260-030-110
----------------	-------------



FERREIRA
Facelift Retractor, 110x22mm blade, 100mm, 4"

With fibre-optic	260-130-110
W/o fibre-optic	260-230-110



DEAVER
Retractor, with fibre-optic, 230mm, 9"

110x25mm blade	170-581-230
----------------	-------------



DEAVER
Retractor, with fibre-optic, 300mm, 12"

25mm blade	170-581-300
------------	-------------



HEANEY-SIMON
Abdominal Retractor, with fibre-optic, 280mm, 11"

115x27mm blade	170-457-102
----------------	-------------



HAJEK
Abdominal Retractor, 180mm, 7"

20mm blade

170-285-165



DEAVER
Grip Retractor, serrated, ergonomic handle

25 x 300mm

171-483-025

38 x 310mm

171-483-138



DEAVER
Retractor, serrated, insulated, 215mm, 8¹/₂"

22mm blade

171-891-215



DEAVER
Retractor, serrated, insulated, 300mm, 12"

25mm blade

171-891-300



DEAVER
Retractor, serrated, 300mm, 12"

38mm blade

171-593-300



DEAVER
Retractor, serrated working end, suction, 300mm, 12"

25mm blade

260-591-300





HEANEY

Retractor, serrated, 270mm, 10^{2/3}"

73x28mm blade	170-459-001
45x25mm blade	170-459-002
82x28mm blade	170-459-003



HEANEY

Retractor, serrated, fibre-optic, 270mm, 10^{2/3}"

73x28mm blade	260-459-001
45x25mm blade	260-459-002
82x28mm blade	260-459-003



CZERNY

Retractor, 38x42mm prongs, 180mm, 7"

36mm blade	170-653-000
------------	-------------



CANNY-RYALL

Retractor, single hook, fenestrated, 200mm, 7^{3/4}"

30mm blade	170-654-030
------------	-------------



MORRIS

Retractor, double-ended, 45x50mm/50x50mm

240mm, 9 ^{1/2} "	170-654-007
---------------------------	-------------



PARKER-LANGENBECK (SET)

Retractor US Army, Fig. 1 & Fig. 2, insulated

220mm, 8 ^{2/3} "	170-687-211
---------------------------	-------------



FREEMAN
Flap Retractor, 205mm, 8"

12mm wide 260-012-205

25mm wide 260-025-205



FREEMAN
Flap Retractor, fibre-optic, 205mm, 8"

12mm blade 260-512-205



LAROE
Undermining Forceps, curved

245mm, 9²/₃" 260-001-250



LAROE
Undermining Forceps, full curved

300mm, 12" 260-002-300



LOCKWOOD
Underminer, lift: 30mm

380mm, 15" 260-603-380

450mm, 19" 260-603-450





Coronal Brow Lift Retractor,
7 prongs

180mm, 7"

260-012-199



Coronal Brow Lift Retractor,
7 prongs, reversed

180mm, 7"

260-012-200



Coronal Brow Lift Retractor,
sharp, 6 prongs

230mm, 9"

260-012-202



FREEMAN
Coronal Brow Lift Retractor, 6 prongs

180mm, 7"

260-012-201



YANCOSKIE
Abdominoplasty Retractor, 6 prongs

150mm, 6"

260-013-201



RETRACTORS / DISSECTORS

Retractors, Elevators,
Spatula & Dissectors



SCULPO
Breast Retractor, double-ended, 37x70mm/22x54mm

230mm, 9"

260-400-310

310mm, 12¹/₄"

260-401-310



SCULPO
Breast Spatula, semi-malleable, serrated, 315mm, 12¹/₃"

150x25mm blade

260-400-315

150x38mm blade

260-438-315



SCULPO
Breast Dissector, blunt, curved

340mm, 13¹/₃"

260-009-000



1:2



BYRD
Breast Dissector, straight, 12mm

230mm, 9"

260-012-230



1:1

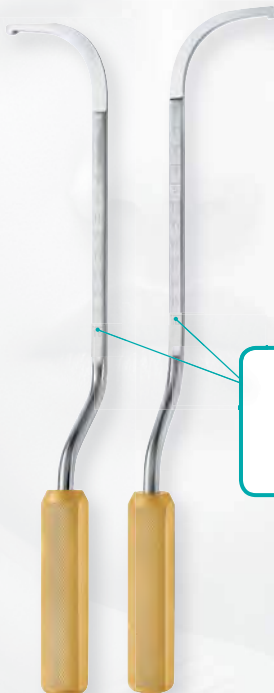

AGRIS-DINGMAN
Transaxillary Dissector Set, with scale

360mm, 14"

260-088-370

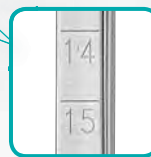

1:1



SCULPO
Breast Elevator, medium curved, insulated shaft

320mm, 12²/₃"

260-001-013



1:1

For creation of submammary pockets.





SCULPO

Breast Dissector, angled

330mm, 13"	260-010-000
420mm, 16 ¹ / ₂ "	260-010-420



SCULPO

Breast Dissector, angled, malleable shaft

330mm, 13"	260-310-000
420mm, 16 ¹ / ₂ "	260-310-420



SCULPO

Breast Dissector, angled, insulated shaft

330mm, 13"	260-010-010
420mm, 16 ¹ / ₂ "	260-010-421



RETRACTORS / DISSECTORS

Breast Dissectors

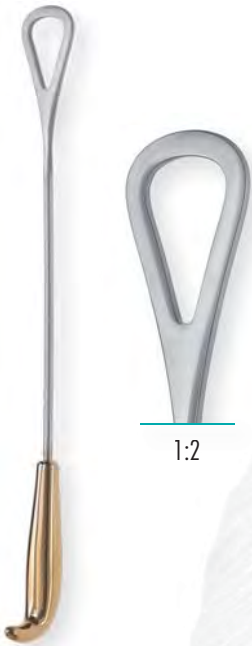

1:2

REYNOLDS

Transaxillary Breast Dissector, fenestrated blade

400mm, 15³/₄"

260-737-040

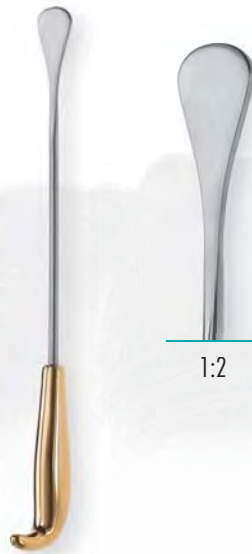

1:2

REYNOLDS

Breast Dissector, oval spatulated blade

320mm, 12²/₃"

260-140-000

420mm, 16¹/₂"

260-140-420



1:2

MACCOLLUM-DINGMAN

Breast Dissector, angled shaft

410mm, 16"

260-016-410

Designed to facilitate tissue dissection when utilizing transaxillary approach for breast augmentation. Can also be used as a subglandular or subpectoral dissector.



1:2

SCULPO

Spatulated Breast Dissector, malleable shaft

330mm, 13"

260-311-000

420mm, 16¹/₂"

260-311-420



1:2

SCULPO

Spatulated Breast Dissector

330mm, 13"

260-011-000

420mm, 16¹/₂"

260-011-420



1:2

SCULPO

Spatulated Breast Dissector

330mm, 13"

260-011-010

420mm, 16¹/₂"

260-011-421



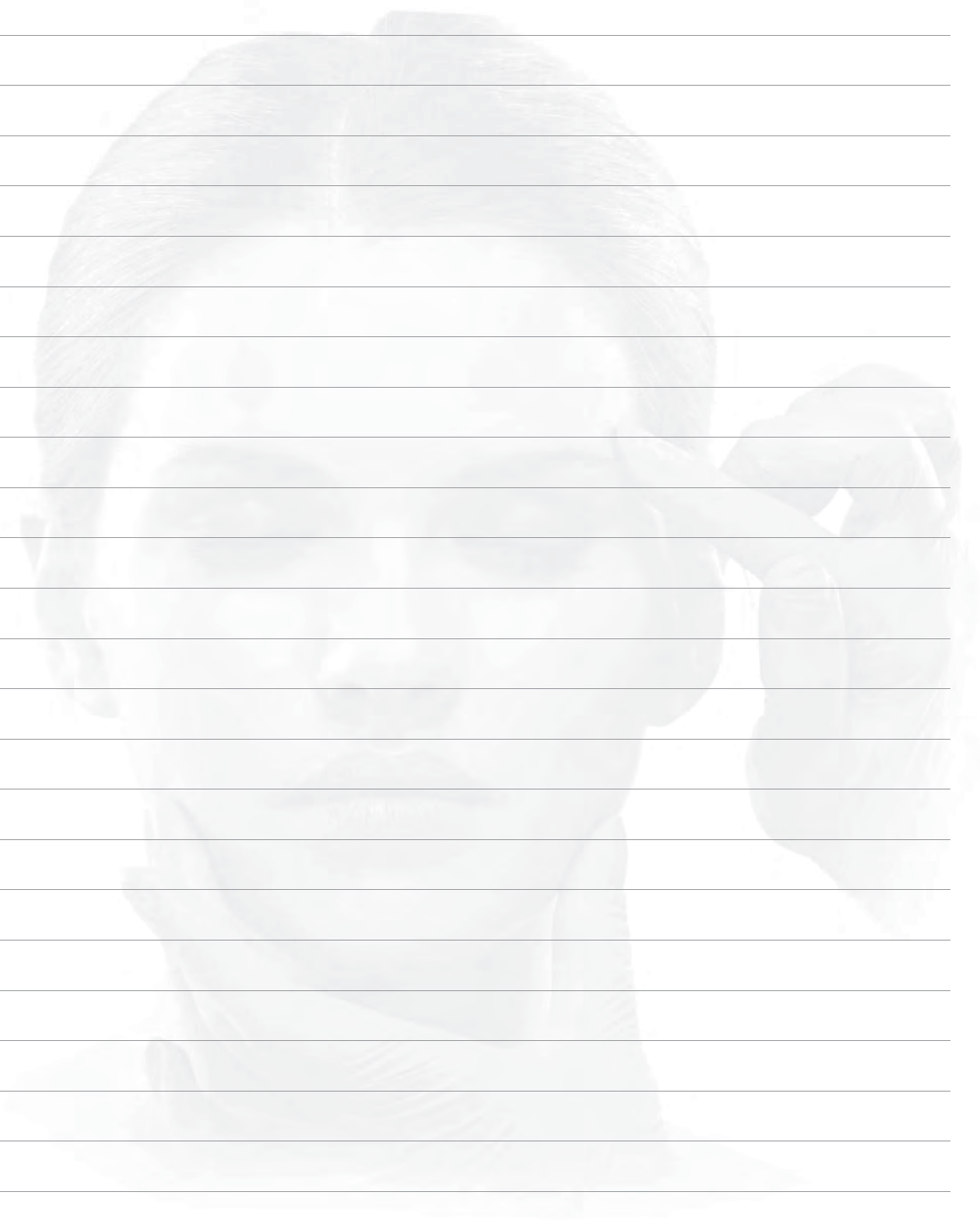



MARKERS & CALIPERS

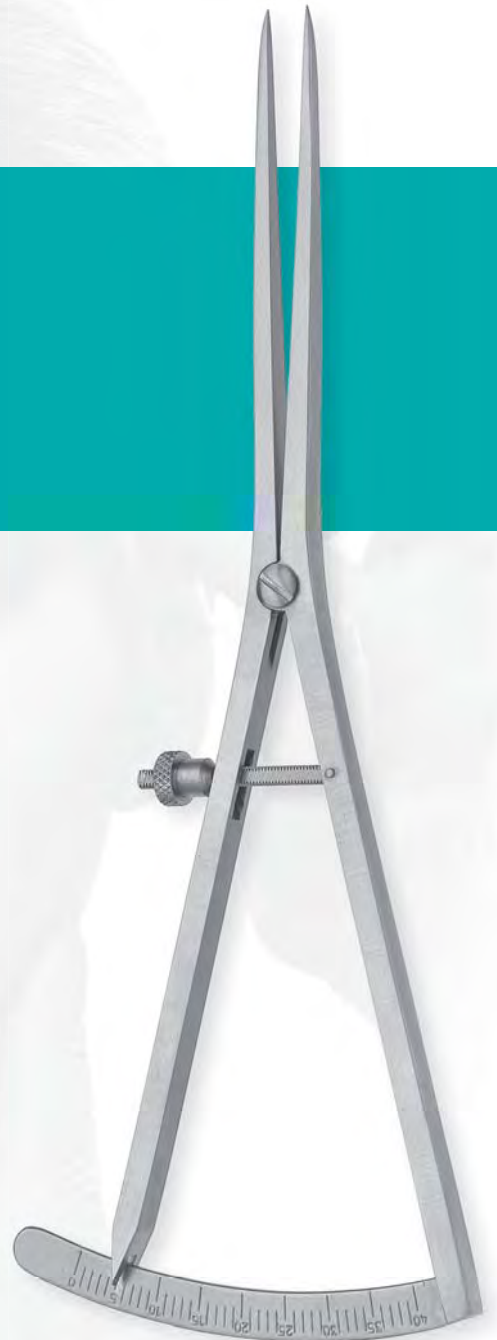



FREEMAN
Areola Marker

Ø 25mm	260-750-125	Ø 40mm	260-750-140
Ø 30mm	260-750-130	Ø 42mm	260-750-142
Ø 34mm	260-750-134	Ø 45mm	260-750-145
Ø 36mm	260-750-136	Ø 50mm	260-750-150
Ø 38mm	260-750-138	Ø 52mm	260-750-152



FREEMAN
Areola Marker, double-ended

Ø 38/42mm	260-751-125
Ø 42/45mm	260-751-142



FREEMAN
Areola Marker, double-ended, with markings

Ø 38/42mm	260-751-225
Ø 34/36mm	260-751-236
Ø 45/50mm	260-751-250



RZ
Areola Marker

Ø 36mm	260-755-036
Ø 38mm	260-755-038
Ø 42mm	260-755-042
Ø 45mm	260-755-045



GROSSMANN
Areola Marker, 4 sizes in 1, non-cutting

40/44/48/52mm	260-754-000
---------------	-------------



GALVAO
Areola Marker

Ø 40mm

260-753-040

Ø 50mm

260-753-050

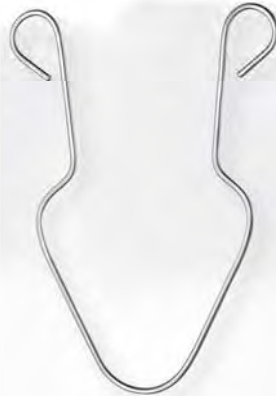

RZ
Areola Marker

100mm

260-746-000

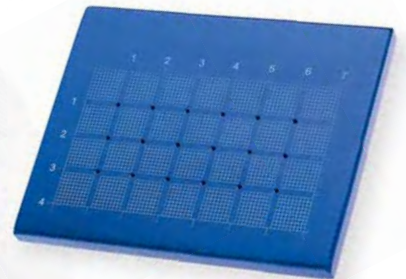

SHEEN
Cartilage grid, aluminium, blue

70x40mm

260-761-000



1:1

ECKHOFF

Skin Marking Pen, with reversible holder for point

145mm, 5^{3/4}"

420-832-145

Spare nib

1 piece

420-832-001



Ink Pot for Skin marking Pen

1 piece

420-832-000



Marking pen

10 pieces (box)

400-832-100





MCKISSOCK

Breast Caliper

Ø 38 mm	260-738-000
Ø 42 mm	260-742-000
Ø 45 mm	260-745-000



HALPERN

Breast Caliper

Ø 38 mm	260-755-000
Ø 42 mm	260-757-000



CASTROVIEJO

Caliper, with locking screw

0-20mm, 85mm	400-583-007
0-40mm, 180mm	400-583-008



Ruler
with mm and inch markings

150mm, 6"	100-418-150
200mm, 8"	100-418-200
300mm, 11 ³ / ₄ "	100-418-300
500mm, 20"	100-418-500



JAMESON

Caliper with locking screw

0-80mm, 95mm	400-421-000
--------------	-------------



THORPE

Caliper, with locking screw

0-80mm, 95mm	400-420-100
--------------	-------------



McKISSOCK (COLLYER)

Caliper

300mm, 12"

260-756-300

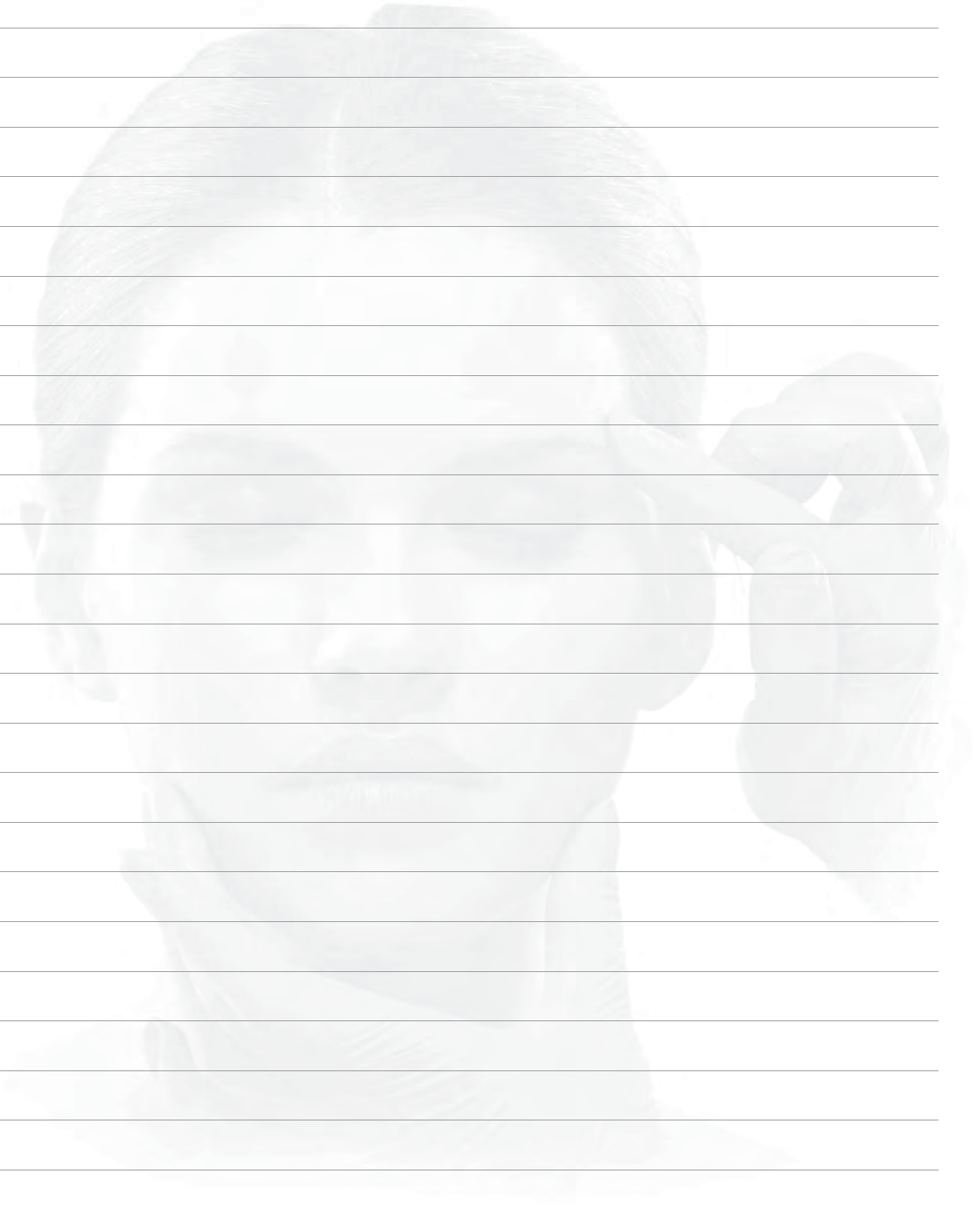



SUCTION INSTRUMENTS



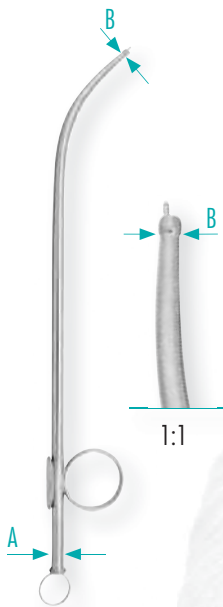

MAGILL
Suction Tube, 245mm, 9³/₄"

Order number	A	B
410-404-030	3.6mm	3.0mm
410-404-035	4.0mm	3.5mm
410-404-040	4.5mm	4.0mm



Nasal Suction Tube, Luer Lock, 180mm, 7"

Order number	A	B
165-064-160	5mm	6.5mm

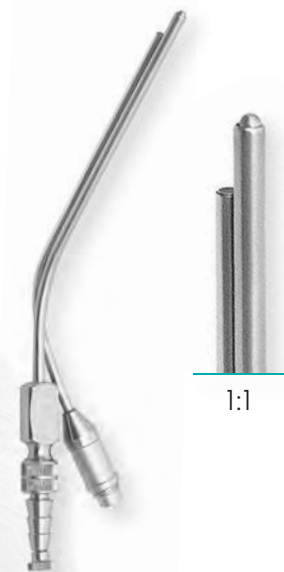

Suction Cannula, fibre-optic connector, 190mm, 7¹/₂"

10 Fr.	165-523-110
12 Fr.	165-523-112

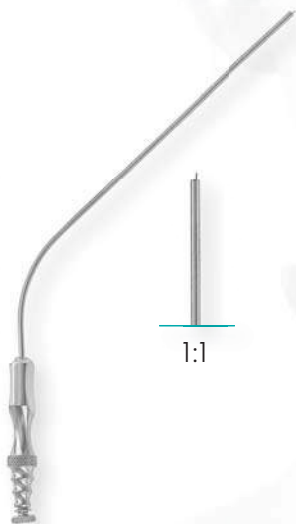

FERGUSON
Suction Tube, 180mm, 7"

6 Fr.	165-525-006
7 Fr.	165-525-007
8 Fr.	165-525-008
10 Fr.	165-525-010
12 Fr.	165-525-012



YANKAUER
Suction Cannula, fibre-optic connector

270mm, 10 ² / ₃ "	165-743-270
---	-------------



ADSON
Suction Cannula, Ø4mm

210mm, 8 ¹ / ₄ "	165-521-004
--	-------------



SUCTION INSTRUMENTS

Suction Elevators,
Dissectors, Raspatories



1:1

GULEN

Suction Elevator, 200mm, 8"

Right curved

165-521-200

Left curved

165-522-200



1:1

NEGUS

Suction Dissector, blunt, Ø 6mm

205mm, 8¹/₈"

420-395-205

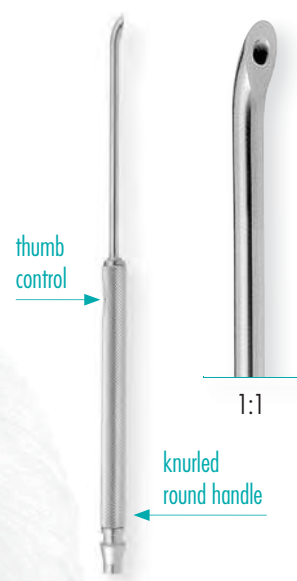

thumb
control

1:1

knurled
round handle

RZ

Nasal Suction Dissector, sharp, Luer Lock, Ø 8mm

190mm, 7¹/₂"

420-310-190



1:1

GORNEY

Suction Raspatory, Ø 3mm, 180mm, 7"

Blunt

420-252-185

Semi-Sharp

420-253-185





Infiltration Cannula for syringes, **22 holes**, screw lock

Order number	WL	Ø Shaft
260-983-200	220mm	3mm
260-984-200	220mm	4mm

Infiltration Cannula for syringes, **30 holes**, screw lock

Order number	WL	Ø Shaft
260-983-300	220mm	3mm
260-984-300	220mm	4mm



Infiltration Cannula for syringes, **1 hole**, Luer Lock

Order number	WL	Ø Shaft
260-981-150	150mm	2mm
260-981-200	200mm	2mm
260-981-250	250mm	2mm
260-981-300	300mm	2mm
260-982-150	150mm	3mm
260-982-200	200mm	3mm
260-982-250	250mm	3mm
260-982-300	300mm	3mm

Infiltration Cannula for syringes, **22 holes**, Luer Lock

Order number	WL	Ø Shaft
260-984-150	150mm	2mm
260-984-201	200mm	2mm
260-984-250	250mm	2mm
260-984-301	300mm	2mm
260-985-150	150mm	3mm
260-985-200	200mm	3mm
260-985-250	250mm	3mm
260-985-301	300mm	3mm



Adaptor with Luer Lock connection, for use of screw lock cannulas on Luer Lock syringes

1 piece	166-972-000
---------	-------------



SUCTION INSTRUMENTS

Liposuction Hand Pieces



With quick lock and lever mechanism

RZ
Liposuction Hand Piece, with lever mechanism

Quick lock

260-900-000



With quick lock and thumb control

RZ
Liposuction Hand Piece, with thumb control

Quick lock

260-910-000



With quick lock and without thumb control

RZ
Liposuction Hand Piece, without thumb control

Quick lock

260-911-000



With luer lock and lever mechanism

RZ
Liposuction Hand Piece, with lever mechanism

Luer lock

260-900-100



With luer lock and thumb control

RZ
Liposuction Hand Piece, with thumb control

Luer lock

260-910-100



With luer lock and without thumb control

RZ
Liposuction Hand Piece, without thumb control

Luer lock

260-911-100





A Liposuction Cannula, for Quick Lock



B Liposuction Cannula, for Luer Lock



TRIPOINT

A for Quick Lock

Order number	WL	Ø Shaft
260-912-150	150mm	2mm
260-913-150	150mm	3mm
260-913-200	200mm	3mm
260-913-250	250mm	3mm
260-913-300	300mm	3mm
260-914-200	200mm	4mm
260-914-250	250mm	4mm
260-914-300	300mm	4mm
260-915-200	200mm	5mm
260-915-250	250mm	5mm
260-915-300	300mm	5mm
260-916-200	200mm	6mm
260-916-250	250mm	6mm
260-916-300	300mm	6mm



TRIPOINT

B for Luer Lock

Order number	WL	Ø Shaft
260-912-151	150mm	2mm
260-913-151	150mm	3mm
260-913-201	200mm	3mm
260-913-251	250mm	3mm
260-913-301	300mm	3mm
260-914-201	200mm	4mm
260-914-251	250mm	4mm
260-914-301	300mm	4mm
260-915-201	200mm	5mm
260-915-251	250mm	5mm
260-915-301	300mm	5mm
260-916-201	200mm	6mm
260-916-251	250mm	6mm
260-916-301	300mm	6mm



MONOPOINT

A for Quick Lock

Order number	WL	Ø Shaft
260-922-150	150mm	2mm
260-923-150	150mm	3mm
260-923-200	200mm	3mm
260-923-250	250mm	3mm
260-923-300	300mm	3mm
260-924-200	200mm	4mm
260-924-250	250mm	4mm
260-924-300	300mm	4mm
260-925-250	250mm	5mm
260-925-300	300mm	5mm



MONOPOINT

B for Luer Lock

Order number	WL	Ø Shaft
260-922-151	150mm	2mm
260-923-151	150mm	3mm
260-923-201	200mm	3mm
260-923-251	250mm	3mm
260-923-301	300mm	3mm
260-924-201	200mm	4mm
260-924-251	250mm	4mm
260-924-301	300mm	4mm
260-925-251	250mm	5mm
260-925-301	300mm	5mm



A Liposuction Cannula, for Quick Lock



B Liposuction Cannula, for Luer Lock



MERCEDES

A for Quick Lock

Order number	WL	Ø Shaft
260-932-150	150mm	2mm
260-933-200	200mm	3mm
260-933-250	250mm	3mm
260-934-200	200mm	4mm
260-934-250	250mm	4mm
260-934-300	300mm	4mm
260-935-250	250mm	5mm
260-935-300	300mm	5mm



MERCEDES

B for Luer Lock

Order number	WL	Ø Shaft
260-932-151	150mm	2mm
260-933-201	200mm	3mm
260-933-251	250mm	3mm
260-934-201	200mm	4mm
260-934-251	250mm	4mm
260-934-301	300mm	4mm
260-935-251	250mm	5mm
260-935-301	300mm	5mm



COBRA

A for Quick Lock

Order number	WL	Ø Shaft
260-952-150	150mm	2mm
260-953-150	150mm	3mm
260-953-200	200mm	3mm
260-953-250	250mm	3mm
260-954-200	200mm	3mm
260-954-250	250mm	4mm
260-954-300	300mm	4mm
260-955-250	250mm	4mm
260-955-300	300mm	5mm



COBRA

B for Luer Lock

Order number	WL	Ø Shaft
260-952-151	150mm	2mm
260-953-151	150mm	3mm
260-953-201	200mm	3mm
260-953-251	250mm	3mm
260-954-201	200mm	3mm
260-954-251	250mm	4mm
260-954-301	300mm	4mm
260-955-251	250mm	4mm
260-955-301	300mm	5mm



A Liposuction Cannula, for Quick Lock



B Liposuction Cannula, for Luer Lock



SPIRALE

A for Quick Lock

Order number	WL	Ø Shaft
260-942-150	150mm	2mm
260-943-150	150mm	3mm
260-943-200	200mm	3mm
260-943-250	250mm	3mm
260-944-200	200mm	4mm
260-944-250	250mm	4mm
260-944-300	300mm	4mm
260-945-250	250mm	5mm
260-945-300	300mm	5mm



SPIRALE

B for Luer Lock

Order number	WL	Ø Shaft
260-942-151	150mm	2mm
260-943-151	150mm	3mm
260-943-201	200mm	3mm
260-943-251	250mm	3mm
260-944-201	200mm	4mm
260-944-251	250mm	4mm
260-944-301	300mm	4mm
260-945-251	250mm	5mm
260-945-301	300mm	5mm



SHARK

A for Quick Lock

Order number	WL	Ø Shaft
260-962-150	150mm	2mm
260-963-150	150mm	3mm
260-963-200	200mm	3mm
260-963-250	250mm	3mm
260-964-200	200mm	4mm
260-964-250	250mm	4mm
260-964-300	300mm	4mm
260-965-250	250mm	5mm
260-965-300	300mm	5mm



SHARK

B for Luer Lock

Order number	WL	Ø Shaft
260-962-151	150mm	2mm
260-963-151	150mm	3mm
260-963-201	200mm	3mm
260-963-251	250mm	3mm
260-964-201	200mm	4mm
260-964-251	250mm	4mm
260-964-301	300mm	4mm
260-965-251	250mm	5mm
260-965-301	300mm	5mm



A Liposuction, complete instrument, **straight**



B Liposuction, complete instrument, **bayonet-shape**



TRIPORT

A straight

Order number	WL	Ø Shaft
260-912-152	150mm	2mm
260-912-202	200mm	2mm
260-912-252	250mm	2mm
260-912-302	300mm	2mm
260-913-152	150mm	3mm
260-913-202	200mm	3mm
260-913-252	250mm	3mm
260-913-302	300mm	3mm
260-914-152	150mm	4mm
260-914-202	200mm	4mm
260-914-252	250mm	4mm
260-914-302	300mm	4mm
260-915-152	150mm	5mm
260-915-202	200mm	5mm
260-915-252	250mm	5mm
260-915-302	300mm	5mm
260-916-152	150mm	6mm
260-916-202	200mm	6mm
260-916-252	250mm	6mm
260-916-302	300mm	6mm



TRIPORT

B bayonet-shape

Order number	WL	Ø Shaft
260-912-153	150mm	2mm
260-912-203	200mm	2mm
260-912-253	250mm	2mm
260-912-303	300mm	2mm
260-913-153	150mm	3mm
260-913-203	200mm	3mm
260-913-253	250mm	3mm
260-913-303	300mm	3mm
260-914-153	150mm	4mm
260-914-203	200mm	4mm
260-914-253	250mm	4mm
260-914-303	300mm	4mm
260-915-153	150mm	5mm
260-915-203	200mm	5mm
260-915-253	250mm	5mm
260-915-303	300mm	5mm
260-916-153	150mm	6mm
260-916-203	200mm	6mm
260-916-253	250mm	6mm
260-916-303	300mm	6mm





A Liposuction, complete instrument, **straight**



B Liposuction, complete instrument, **bayonet-shape**



MONOPORT

A straight

Order number	WL	Ø Shaft
260-922-152	150mm	2mm
260-922-202	200mm	2mm
260-922-252	250mm	2mm
260-922-302	300mm	2mm
260-923-152	150mm	3mm
260-923-202	200mm	3mm
260-923-252	250mm	3mm
260-923-302	300mm	3mm
260-924-152	150mm	4mm
260-924-202	200mm	4mm
260-924-252	250mm	4mm
260-924-302	300mm	4mm
260-925-152	150mm	5mm
260-925-202	200mm	5mm
260-925-252	250mm	5mm
260-925-302	300mm	5mm
260-926-152	150mm	6mm
260-926-202	200mm	6mm
260-926-252	250mm	6mm
260-926-302	300mm	6mm



MONOPORT

B bayonet-shape

Order number	WL	Ø Shaft
260-922-153	150mm	2mm
260-922-203	200mm	2mm
260-922-253	250mm	2mm
260-922-303	300mm	2mm
260-923-153	150mm	3mm
260-923-203	200mm	3mm
260-923-253	250mm	3mm
260-923-303	300mm	3mm
260-924-153	150mm	4mm
260-924-203	200mm	4mm
260-924-253	250mm	4mm
260-924-303	300mm	4mm
260-925-153	150mm	5mm
260-925-203	200mm	5mm
260-925-253	250mm	5mm
260-925-303	300mm	5mm
260-926-153	150mm	6mm
260-926-203	200mm	6mm
260-926-253	250mm	6mm
260-926-303	300mm	6mm



A Liposuction, complete instrument, **straight**



B Liposuction, complete instrument, **bayonet-shape**



MERCEDES

A straight

Order number	WL	Ø Shaft
260-932-152	150mm	2mm
260-932-202	200mm	2mm
260-932-252	250mm	2mm
260-932-302	300mm	2mm
260-933-152	150mm	3mm
260-933-202	200mm	3mm
260-933-252	250mm	3mm
260-933-302	300mm	3mm
260-934-152	150mm	4mm
260-934-202	200mm	4mm
260-934-252	250mm	4mm
260-934-302	300mm	4mm
260-935-152	150mm	5mm
260-935-202	200mm	5mm
260-935-252	250mm	5mm
260-935-302	300mm	5mm
260-936-152	150mm	6mm
260-936-202	200mm	6mm
260-936-252	250mm	6mm
260-936-302	300mm	6mm



MERCEDES

B bayonet-shape

Order number	WL	Ø Shaft
260-932-153	150mm	2mm
260-932-203	200mm	2mm
260-932-253	250mm	2mm
260-932-303	300mm	2mm
260-933-153	150mm	3mm
260-933-203	200mm	3mm
260-933-253	250mm	3mm
260-933-303	300mm	3mm
260-934-153	150mm	4mm
260-934-203	200mm	4mm
260-934-253	250mm	4mm
260-934-303	300mm	4mm
260-935-153	150mm	5mm
260-935-203	200mm	5mm
260-935-253	250mm	5mm
260-935-303	300mm	5mm
260-936-153	150mm	6mm
260-936-203	200mm	6mm
260-936-253	250mm	6mm
260-936-303	300mm	6mm



A Liposuction, complete instrument, **straight**



B Liposuction, complete instrument, **bayonet-shape**



COBRA

A straight

Order number	WL	Ø Shaft
260-952-152	150mm	2mm
260-952-202	200mm	2mm
260-952-252	250mm	2mm
260-952-302	300mm	2mm
260-953-152	150mm	3mm
260-953-202	200mm	3mm
260-953-252	250mm	3mm
260-953-302	300mm	3mm
260-954-152	150mm	4mm
260-954-202	200mm	4mm
260-954-252	250mm	4mm
260-954-302	300mm	4mm
260-955-152	150mm	5mm
260-955-202	200mm	5mm
260-955-252	250mm	5mm
260-955-302	300mm	5mm
260-956-152	150mm	6mm
260-956-202	200mm	6mm
260-956-252	250mm	6mm
260-956-302	300mm	6mm



COBRA

B bayonet-shape

Order number	WL	Ø Shaft
260-952-153	150mm	2mm
260-952-203	200mm	2mm
260-952-253	250mm	2mm
260-952-303	300mm	2mm
260-953-153	150mm	3mm
260-953-203	200mm	3mm
260-953-253	250mm	3mm
260-953-303	300mm	3mm
260-954-153	150mm	4mm
260-954-203	200mm	4mm
260-954-253	250mm	4mm
260-954-303	300mm	4mm
260-955-153	150mm	5mm
260-955-203	200mm	5mm
260-955-253	250mm	5mm
260-955-303	300mm	5mm
260-956-153	150mm	6mm
260-956-203	200mm	6mm
260-956-253	250mm	6mm
260-956-303	300mm	6mm



A Liposuction, complete instrument, **straight**



B Liposuction, complete instrument, **bayonet-shape**



SPIRALE

A straight

Order number	WL	Ø Shaft
260-942-152	150mm	2mm
260-942-202	200mm	2mm
260-942-252	250mm	2mm
260-942-302	300mm	2mm
260-943-152	150mm	3mm
260-943-202	200mm	3mm
260-943-252	250mm	3mm
260-943-302	300mm	3mm
260-944-152	150mm	4mm
260-944-202	200mm	4mm
260-944-252	250mm	4mm
260-944-302	300mm	4mm
260-945-152	150mm	5mm
260-945-202	200mm	5mm
260-945-252	250mm	5mm
260-945-302	300mm	5mm
260-946-152	150mm	6mm
260-946-202	200mm	6mm
260-946-252	250mm	6mm
260-946-302	300mm	6mm



SPIRALE

B bayonet-shape

Order number	WL	Ø Shaft
260-942-153	150mm	2mm
260-942-203	200mm	2mm
260-942-253	250mm	2mm
260-942-303	300mm	2mm
260-943-153	150mm	3mm
260-943-203	200mm	3mm
260-943-253	250mm	3mm
260-943-303	300mm	3mm
260-944-153	150mm	4mm
260-944-203	200mm	4mm
260-944-253	250mm	4mm
260-944-303	300mm	4mm
260-945-153	150mm	5mm
260-945-203	200mm	5mm
260-945-253	250mm	5mm
260-945-303	300mm	5mm
260-946-153	150mm	6mm
260-946-203	200mm	6mm
260-946-253	250mm	6mm
260-946-303	300mm	6mm



A Liposuction, complete instrument, **straight**



B Liposuction, complete instrument, **bayonet-shape**



SHARK

A straight

Order number	WL	Ø Shaft
260-962-152	150mm	2mm
260-962-202	200mm	2mm
260-962-252	250mm	2mm
260-962-302	300mm	2mm
260-963-152	150mm	3mm
260-963-202	200mm	3mm
260-963-252	250mm	3mm
260-963-302	300mm	3mm
260-964-152	150mm	4mm
260-964-202	200mm	4mm
260-964-252	250mm	4mm
260-964-302	300mm	4mm
260-965-152	150mm	5mm
260-965-202	200mm	5mm
260-965-252	250mm	5mm
260-965-302	300mm	5mm
260-966-152	150mm	6mm
260-966-202	200mm	6mm
260-966-252	250mm	6mm
260-966-302	300mm	6mm



SHARK

B bayonet-shape

Order number	WL	Ø Shaft
260-962-153	150mm	2mm
260-962-203	200mm	2mm
260-962-253	250mm	2mm
260-962-303	300mm	2mm
260-963-153	150mm	3mm
260-963-203	200mm	3mm
260-963-253	250mm	3mm
260-963-303	300mm	3mm
260-964-153	150mm	4mm
260-964-203	200mm	4mm
260-964-253	250mm	4mm
260-964-303	300mm	4mm
260-965-153	150mm	5mm
260-965-203	200mm	5mm
260-965-253	250mm	5mm
260-965-303	300mm	5mm
260-966-153	150mm	6mm
260-966-203	200mm	6mm
260-966-253	250mm	6mm
260-966-303	300mm	6mm



Disposable Plastic Syringe, package of 60 pieces, individually packaged, sterile *

50/60ml

166-970-060



Syringe, with stop *

50ml

166-970-050

10ml

166-970-010

Spare cartridge for syringe *

50ml

166-970-051

10ml

166-970-011



Stop for Disposable Plastic Syringe 166-970-060 *

For 20ml

166-970-200

For 30ml

166-970-300

For 50/60ml

166-970-100



The stop maintains the vacuum in the syringe.

*Instruments only available without CE mark.



Lipo-Injection dosing handle

260-810-000



Illustration: Disposable syringe with injection cannula (not included)

The Lipo-Injection dosing handle for the injection of endogenous fat into the facial area (Toledo technique) is used with standard one-way plastic syringes (20ml, 3-part with Luer-Lock connector). Suitable Injection cannulas are also available in different sizes.

Compared to the metal handle the synthetic design is much more lightweight. The accurate dosing mechanism allows to prepare very precise and delicate doses.

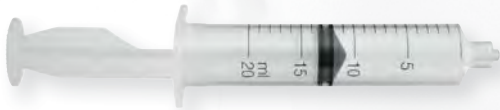

Disposable Syringes, package of 50 pcs, suitable for Dosing-Handle 166-970-060

20ml

260-811-020



Injection Cannula, with Luer Lock, suitable for Disposable Syringe 166-970-050

1.2 x 40mm

260-811-124

2.0 x 40mm

260-811-204

1.2 x 60mm

260-811-126

2.0 x 60mm

260-811-206



Transfer adaptor, for the connection of two Luer Lock syringes in order to transfer the content

1 piece

166-974-000



Syringe Holding Device, for safe storage of Luer Lock syringes containing fat

1 piece

166-975-000

PREPARATION OF LIPO TRANSFER



1 Dismantle the disposable plastic syringe.



2 Attach the rubber stop to the metal fixing device.



3 Push the barrel over the rubber stop up to the bayonet.



4 Lock the barrel by turning in the direction shown by the arrow.



5 Push the rubber stop into the barrel by pressing the handle.



6 Set the injection cannula (with Luer Lock) on the disposable syringe and lock by turning in the direction shown by the arrow.



7 Finished! The Lipo-Injection is ready for application.

Please note: Lipo-Transfer as well as its preparation should only be done under sterile conditions!

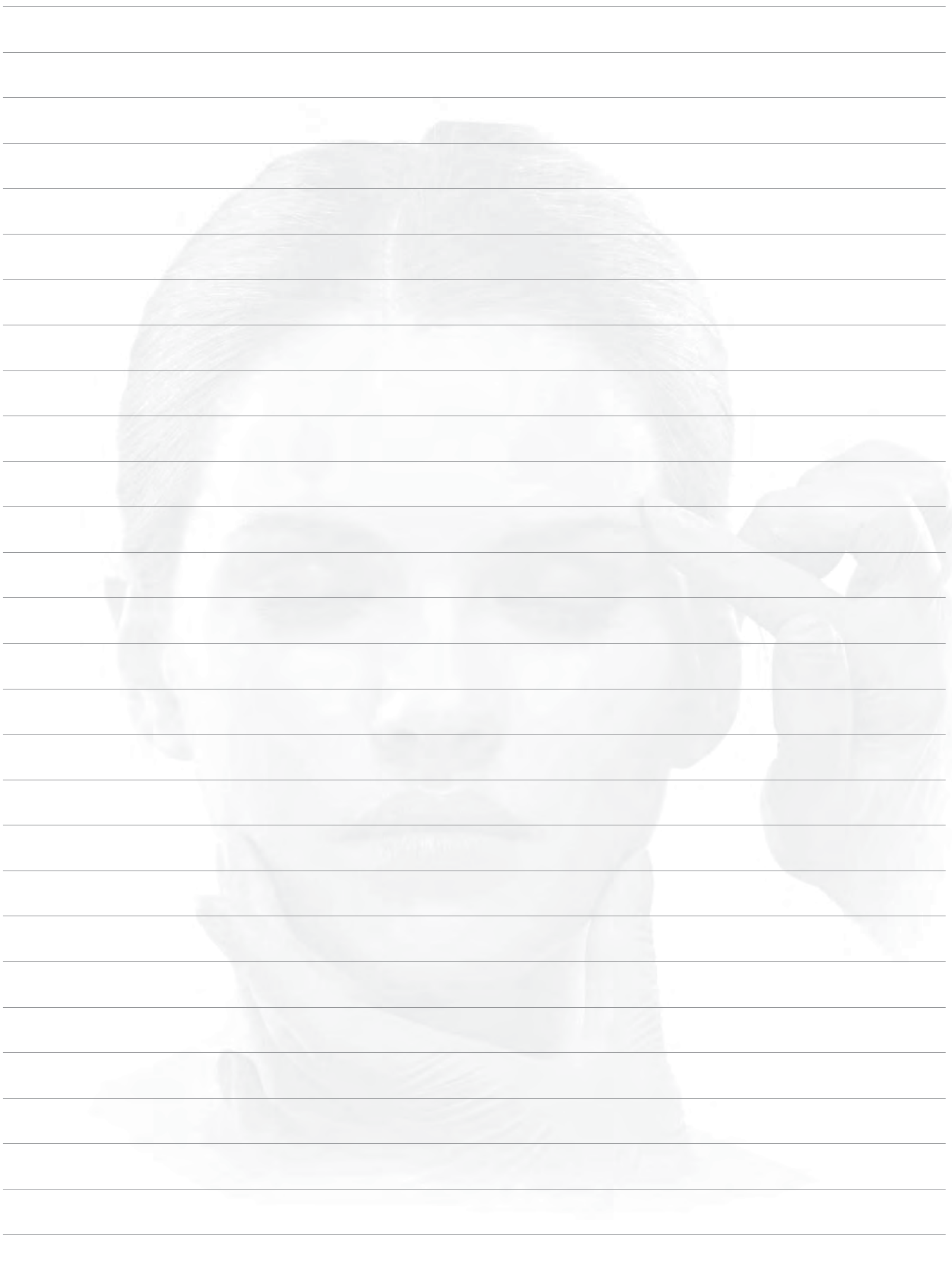



DEVICES & ACCESSORIES





Electrosurgical Generator G400

- Automatic power regulation
- Detects and identifies connected instrument, and selects the appropriate program automatically (SDS plug only)
- Powerstart System eases the beginning of cutting process
- 105 various automatic programs in 7 groups
- Real-time monitoring of output parameters
- For bipolar TUR-B/P and monopolar TUR-P

Delivery contains

- Main Unit, mains cable, operating manual

Power Supply

Power supply voltage	230V ± 10% 50Hz or 110V ± 10% 60Hz
Nominal power consumption	770 VA

Argon

Argon-type	4.8 (99,998%) or higher
Gas input pressure	0.25–0.4 [MPa]
Gas outflow	0.1–10.0 [l/min]
Adjustment	0.1 l/min throughout the range
Pressure measurement	Reducer (with manometer) (0.4 [MPa]) on argon cylinder

Other

Device dimensions	495 x 415 x 225mm, with display
Weight	12.2kg

Order number

Description

WITHOUT ARGON

700-350-400	Electrosurgical Generator G400, 230V
700-350-410	Electrosurgical Generator G400, 110V

Order number

Description

WITH ARGON

700-350-420	Electrosurgical Generator G400, 230V, with Argon
700-350-430	Electrosurgical Generator G400, 110V, with Argon

Safety conditions – Electric shock protection

Class/Grade	I/CF
Protection degree	IP2X
Low-frequency leakage currents	acc. to IEC 60601-1
High-frequency leakage currents	acc. to IEC 60601-2-2
Generator operation frequency	333kHz
Defibrillation impulse resistance	acc. to EN 60601-1
High-frequency leakage currents	acc. to IEC 60601-2-2
Defibrillation impulse resistance	acc. to EN 60601-1
NEM system	neutral electrode control optical indication 7 levels required resistance < 240 Ω
Manufactured and tested	acc. to EN60601-1, EN60601-2-2
Protection degree	IP2X



Order number	Length	Description
700-350-405	5m	2-Button-Footswitch



Order number	Length	Description
700-350-404	5m	2-Button-Footswitch, Quick Access Key

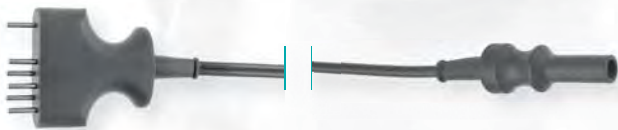

Order number	Length	Description
700-501-300	3m	Monopolar Cable, SDS to 4mm female
700-501-500	5m	Monopolar Cable, SDS to 4mm female



Order number	Length	Description
700-500-300	3m	Bipolar Cable, SDS to straight connector
700-500-500	5m	Bipolar Cable, SDS to straight connector

OTHER ACCESSORIES

Order number	Description
700-504-000	Reusable Neutral Electrode, 30x17cm, 4m
700-801-100	Rubber Band for Fixation of Neutral Electrodes, 100cm
700-801-900	Button for Rubber Band
700-503-003	Cable for Disposable Neutral Electrode, 5m

Many other accessories are available on request.
Feel free to contact your area manager!



Full HD recording function
(F4 only)



USB flash drive included
(F4 only)



Ergonomic high-end
camera head included

Order number

Description

300-001-800	3 Chip HD-Camera F3
300-001-804	3 Chip HD-Camera F4

FULL HD

3 Chip HD-Camera F3

The Full HD camera system generates crystal clear images of highest resolution with 1920 x 1080 pixels. The latest MOS technology produces pure natural colors for safe and unequivocal diagnoses. A user-friendly multilingual menu allows a large variety of setups for individual procedures and surgeons preferences.

The ergonomic camera head features 3 remote control buttons which can be programmed by the user as required during surgery. A multitude of digital video outputs allows the best possible picture transmission to the medical grade monitors.

3 Chip HD-Camera F4

The brand new F4 camera system combines our F3 system with a Full HD recording function. Pictures and videos can be stored easily on a USB flash drive. Recorded data can be used for an extensive documentation of the procedures.

Delivery contains

- Main unit
- Camera head
- HDMI-DVI cable
- HDMI cable
- S-Video cable
- Mains cable
- User manual
- USB flash drive (F4 only)

Features F3

- Full HD-Camera with latest 3-MOS technology for brilliant picture quality
- Pure Natural Colors technology
- Multitude of digital video outputs for best possible picture transmission to medical grade monitors
- Ergonomic camera head with 3 programmable remote control buttons
- User-friendly multilingual menu allows a large variety of setups for individual procedures and surgeons preferences

Features F4

- All features of the F3 model
- Full HD 60fps video recording
- Full HD image saving
- USB pen drive included
- Text generator (optional with keyboard)



FULL HD



300-001-616 Title generator keyboard, waterproof IP68, US-Layout, USB Connector, cable 1.8m, Color: grey, 305x140x15mm, 600gr.



300-001-610 Footswitch for HD Cameras, cable length: 2m

300-001-802 High-End 3-MOS Camera Head Full HD 1920 x 1080p (included)

Technical data

Camera head	Aspect ratio: 16:9
	Image sensor: 3 MOS
	Immersible (using the attached cap)
System	Image resolution: Full HD 1920 x 1080
	TV resolution: > 1000 lines, horizontal
	Min. Sensivity: < 3 lux (1/1.4)
	White balance automatically, with data hold
	Shutter speed: 1/50 (1/60) to 1/100.000 sec
	Power supply: 100/240 VAC, 47-63 Hz
	Power consumption: 20VA (~ 20W)
	Fuses: 2 Fine fuses, 5x20 mm, delay acting 3,15 AH (I=1500A)

Technical data

Video recording (F4 only)	Video format: Full HD 1920x1080p / Mpeg4 (H.264) / Frame rate: 60 fps
	Image format: JPG (1920x1080)
Video out (digital)	2x HD SDI, 1x HDMI/DVI
Video out (analogue)	1x YPbPr/RGB, 1x Y/C (Pal/NTSC), 1x CVBS (Pal/NTSC)
Recording connection	1 x USB A (only F4)
Standards	Classification acc. 93/42/EEC: I
	Protection class: I
	Application part type: BF
	Protection type: IP21
	EMC classification: 1B
Dimensions	Control unit: 380 x 131.5 x 375.5 mm (WxHxD); 11 kg
	Camera head: Ø38.5mm, length: 81mm, 145g



Full HD recording function
(F2 Pro only)



USB flash drive included
(F2 Pro only)



Ergonomic high-end
camera head included

FULL HD

Order number

Description

300-001-600	HD-Camera F1
300-001-601	HD-Camera F2 Pro

HD-Camera F1

The new F1 camera system fulfills the need of high resolution in video endoscopic surgery. Thanks to Full HD resolution combined with newest technology this camera generates crystal-clear images with highest attention to detail that allows better diagnostics and more efficient surgery.

HD-Camera F2 Pro

The brand new F2 Pro camera system combines our F1 system with a Full HD recording function. Pictures and videos can be stored easily on a USB flash drive. Recorded data can be used for an extensive documentation of the procedures.

Delivery contains

- Main Unit
- Camera head
- HDMI - DVI cable
- HDMI cable
- S-Video cable
- RGB-Cable
- BNC cable
- Mains cable
- Operating manual
- USB pen drive (F2 Pro only)

Features F1

- Pure Natural Colors technology
- Multitude of digital video outputs for best possible picture transmission to medical grade monitors
- Ergonomic camera head with 3 programmable remote control buttons
- User-friendly multilingual menu allows a large variety of setups for individual procedures and surgeons preferences

Features F2 Pro

- All F3 features
- Full HD 60fps video recording
- Full HD image saving
- USB flash drive included
- Text generator (optional with keyboard)



300-001-602 High-End 1/3" MOS Camera Head Full HD 1920 x 1080p (included)

FULL HD



300-001-616 Title generator keyboard, waterproof IP68, US-Layout, USB Connector, cable 1.8m, Color: grey, 305x140x15mm, 600gr. (optional)



300-001-610 Footswitch for HD Cameras, cable length: 2m (optional)

Technical data

Camera head	Aspect ratio: 16:9 Image sensor: 1/3" MOS Immersible (using the attached cap)
System	Image resolution: Full HD 1920 x 1080 TV resolution: > 1000 lines, horizontal Min. Sensivity: < 3 lux (1/1.4) White balance automatically, with data hold Shutter speed: 1/50 (1/60) to 1/100.000 sec Power supply: 100/240 VAC, 47-63 Hz Power consumption: 20VA (~ 20W) Fuses: 2 Fine fuses, 5x20 mm, delay acting 3,15 AH (I=1500A)

Technical data

Video recording (F4 only)	Video format: Full HD 1920x1080p / Mpeg4 (H.264) / Frame rate: 60 fps Image format: JPG (1920x1080)
Video out (digital)	2x HD SDI (optional), 1x HDMI/DVI
Video out (analogue)	1x YPbPr/RGB, 1x Y/C (Pal/NTSC), 1x CVBS (Pal/NTSC)
Recording connection	1 x USB A (only F2 Pro)
Standards	Classification acc. 93/42/EEC: I Protection class: I Application part type: BF Protection type: IP21 EMC classification: 1B
Dimensions	Control unit: 380 x 131.5 x 375.5 mm (WxHxD); 11 kg Camera head: Ø 34mm, length: 78mm, 105g

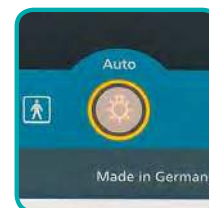

Automatic light control



Controlable daylight quality

LUMEN LED 3

Latest PHASER® technology for unsurpassed medical lighting. Excellent light sources are characterised by high color rendering, high luminance and a very low ultraviolet and infrared radiation. With the LUMEN LED 3 light source RZ Medizintechnik offers the latest technology in medical lighting, made in Germany. Whether the light source is used with modern headlights or in endoscopic surgeries, the new PHASER® technology always generates enough light for meaningful pictures.

Features

- 30.000h lamp lifetime
- Latest PHASER® technology
- Waterproof touch control panel
- High colour rendering
- High luminance
- Daylight color temperature
- Low noise level
- No UV or IR light
- Low power consumption

Delivery contains

- Main unit
- BNC cable
- Mains cable
- User manual

Order number

300-900-300

Description

LUMEN LED 3 High Intensity Light Source

Technical data

Mains voltage	100-240 VAC, 47-63Hz
Power consumption	max. 200VA (±10%)
Mains fuses	2 fine fuses, 5x20mm, delay acting 6.3AT, with high breaking capacity (Ia =1500 A)
LED lifetime	30.000h
Color temperature	6000K (±500K)
Light guide connection	RZ / STORZ compatible
Video in terminal	1 x Video (VBS)
Service	1 x RJ45
Storage temperature	-20°C to +60°C
Operation temperature	+10°C to +40°C
Relative humidity	Storage: 10% to 90% Operation: 30% to 75%
Atmospheric pressure	Storage: 600mbar to 1300mbar Operation: 700mbar to 1060mbar
Application part type	BF
Test according to	IEC 601-1ff, EN 60601-1ff
Classification acc. 93/42/EEC	I
Dimensions	380 x 131.5 x 375.5mm (W x H x D)
Weight	approx. 12 kg



Automatic or manual light intensity control



Digital light intensity display

LUMEN LED 1

Benefitting from the newest LED technology, this light source offers increased luminous efficiency by lowering heat conduction and operating costs. The daylight quality LED lamp lifetime is more than 20.000 hours to provide enhanced working.

Features

- 20.000h lamp lifetime
- Manual or automatic light control
- Waterproof touch control panel
- Low heat conduction by improved LED technology
- Boost Function: temporarily increase of light power of 20% additionally to the 100% light output

Delivery contains

- Main unit
- BNC cable
- Mains cable
- User manual

Order number	Description
300-900-180	LUMEN LED 1 High Intensity Light Source, 180W

Technical data	
Mains voltage	100-240 VAC, 47-63Hz
Power consumption	max. 100VA (±10%)
Mains fuses	2 fine fuses, 5x20mm, delay acting 6.3 AT, with high breaking capacity (I _a = 1500 A)
LED lifetime	20.000h
Color temperature	6500 K
Light guide connection	RZ / STORZ compatible
Video in terminal	1 x Video (VBS)
Service	1 x RJ45
Storage temperature	-20°C to +60°C
Operation temperature	+10°C to +40°C
Relative humidity	Storage: 10% to 90% Operation: 30% to 75%
Atmospheric pressure	Storage: 600mbar to 1300mbar Operation: 700mbar to 1060mbar
Application part type	BF
Test according to	IEC 601-1ff, EN 60601-1ff
Classification acc. 93/42/EEC	I
Dimensions	380 x 131.5 x 375.5mm (W x H x D)
Weight	approx. 8.5 kg

Xenon Fibre Optic Light Guide Cable, without adaptor pieces

Diameter	Length	Order number
Ø 3.5mm	1800mm	250-035-180
	2300mm	250-035-230
	3000mm	250-035-300
Ø 4.8mm	1800mm	250-048-180
	2300mm	250-048-230
	3000mm	250-048-300



Adaptor pieces for fibre light guide, **light source end**



250-039-000 RZ/Storz



250-038-000 ACMI/British Standard/CUDA



250-048-000 Luxtec



250-051-000 Stryker



250-037-000 Wolf



250-044-000 Olympus



250-045-000 Olympus-Strandrad



250-052-000 Heine



250-059-000 Pentax

Adaptor pieces for fibre light guide, **endoscope end**



250-042-000 RZ/Storz/Olympus



250-040-000 Wolf



250-041-000 ACMI/British Standard

Order number	Page	Order number	Page	Order number	Page	Order number	Page
100-418-150	218	120-099-100	51	120-528-170	25	121-031-145	50
100-418-200	218	120-110-115	47	120-528-190	25	121-031-170	50
100-418-300	218	120-111-115	47	120-528-230	25	121-060-140	42
100-418-500	218	120-111-180	5	120-529-170	25	121-061-115	55
110-090-000	165	120-120-150	43	120-529-190	25	121-061-140	42
110-090-001	165	120-121-150	9, 43	120-529-230	25	121-065-130	40
110-090-100	165	120-131-110	44	120-531-170	49	121-070-110	41
110-090-150	165	120-131-135	9	120-535-135	36	121-071-110	41
110-096-019	165	120-132-200	52	120-538-150	33	121-075-105	7
110-096-119	165	120-133-200	52	120-561-140	42	121-077-170	27
110-096-180	165	120-134-120	41	120-565-120	56	121-077-205	27
110-096-185	165	120-135-115	11, 52	120-568-190	22	121-081-100	53
110-097-305	165	120-141-120	43	120-569-190	22	121-089-130	53
110-098-305	165	120-173-180	35	120-570-145	24	121-091-095	51
110-098-399	165	120-209-180	35	120-570-180	24	121-093-105	37
110-110-003	7, 9, 11, 159	120-220-090	55	120-571-115	36	121-094-115	39
110-130-077	7	120-281-110	45	120-571-145	24	121-095-115	7, 39
110-140-000	159	120-281-130	45	120-571-180	24	121-098-100	51
110-140-004	159	120-283-130	45	120-572-170	23	121-099-100	51
110-148-000	159	120-283-140	42	120-572-190	23	121-100-120	53
110-201-010	9	120-286-220	46	120-572-230	23	121-101-120	53
110-201-011	11	120-287-220	46	120-573-170	23	121-111-145	48
110-201-015	9, 11	120-305-105	43	120-573-190	23	121-111-180	48
110-355-000	166	120-310-180	26	120-573-205	23	121-111-200	48
110-355-100	167	120-311-180	26	120-573-230	23	121-111-230	48
110-355-200	167	120-315-150	38	120-574-170	31	121-111-280	48
120-030-170	5	120-315-180	38	120-575-145	32	121-131-110	44
120-031-170	5, 7	120-323-110	36	120-576-170	28	121-132-200	52
120-031-230	5	120-330-145	39	120-576-190	28	121-133-200	52
120-046-160	43	120-338-150	33	120-576-230	23	121-134-120	41
120-047-160	43	120-339-170	44	120-577-170	28	121-137-145	34
120-059-140	42	120-411-090	45	120-577-205	28	121-139-135	34
120-061-115	55	120-500-170	29	120-580-230	57	121-153-145	49
120-065-120	40	120-500-200	29	120-580-250	57	121-153-180	49
120-065-130	40	120-501-170	29	120-580-305	57	121-153-200	49
120-065-150	40	120-501-200	29	120-580-355	57	121-153-230	49
120-065-180	40	120-506-145	50	120-583-180	9, 46	121-182-115	54
120-065-200	40	120-506-170	50	120-584-170	21	121-183-115	54
120-065-230	40	120-506-230	50	120-584-190	21	121-184-115	54
120-073-080	43	120-507-145	9, 50	120-584-230	21	121-185-115	54
120-078-100	51	120-507-170	50	120-585-170	21	121-186-115	54
120-078-105	51	120-507-225	7	120-585-180	46	121-187-115	54
120-079-105	43	120-507-230	50	120-585-190	21	121-188-145	54
120-080-095	51	120-510-115	47	120-585-230	21	121-189-145	54
120-080-115	41	120-510-145	7, 48	120-586-190	20	121-190-140	54
120-081-095	51	120-510-180	48	120-587-190	20	121-191-140	54
120-081-115	41	120-510-200	48	120-588-220	46	121-196-110	37
120-082-100	41	120-510-230	48	120-591-140	34	121-197-110	37
120-083-100	41	120-510-280	48	120-593-115	38	121-204-200	32
120-083-105	51	120-511-115	47	120-595-115	39	121-209-180	35
120-084-100	45	120-511-145	7, 48	120-595-180	34	121-211-180	31
120-084-120	55	120-511-180	48	120-611-115	55	121-211-200	31
120-091-095	11, 52	120-511-200	48	120-611-140	55	121-211-230	31
120-092-105	37	120-511-230	48	120-611-180	55	121-214-150	32
120-092-115	37	120-511-280	48	120-611-230	55	121-214-200	32
120-092-125	37	120-514-145	48	120-666-130	36	121-280-145	9, 44
120-092-182	28	120-514-180	48	120-667-130	36	121-290-165	46
120-093-105	37	120-514-230	48	120-966-130	36	121-296-120	53
120-093-115	37	120-515-145	48	120-967-130	36	121-300-170	29
120-093-125	37	120-515-180	48	121-011-125	53	121-300-200	29
120-093-182	28	120-515-230	48	121-012-125	53	121-301-170	29
120-094-115	39	120-520-145	49	121-030-145	50	121-301-200	29
120-095-115	39	120-521-145	49	121-030-170	50	121-304-170	30
120-098-100	51	120-527-145	49	121-030-230	50	121-304-200	30



INDEX

Numerical Index

Order number	Page	Order number	Page	Order number	Page	Order number	Page
121-305-170	30	123-196-110	38	130-536-150	66	130-752-180	71
121-305-200	30	123-196-120	38	130-536-175	65	130-752-210	71
121-310-170	25	123-197-110	38	130-542-210	65	130-752-250	71
121-310-190	25	123-197-120	38	130-537-120	67	130-752-300	71
121-310-230	25	123-197-150	38	130-537-150	67	130-753-145	71
121-311-170	25	123-300-200	28	130-538-120	65	130-753-180	71
121-311-190	25	123-301-200	28	130-538-150	65	130-753-210	71
121-311-230	25	123-305-170	30	130-541-180	66	130-753-250	71
121-312-150	33	123-305-200	30	130-542-150	65	130-753-300	71
121-313-150	33	123-311-190	26	130-542-180	65	130-754-145	71
121-313-170	35	123-312-150	33	130-548-120	60	130-754-180	71
121-315-150	38	123-313-150	33	130-548-150	60	130-754-210	71
121-317-110	47	123-317-110	47	130-550-120	63	130-754-250	71
121-317-145	47	123-317-145	47	130-550-150	63	140-050-038	79
121-318-125	40	123-505-225	31	130-554-160	63	140-051-038	79
121-319-170	49	123-518-125	40	130-554-200	63	140-160-100	78
121-320-180	44	123-526-145	42	130-561-125	64	140-160-130	78
121-326-145	24	123-527-145	42	130-562-230	5	140-160-190	78
121-326-180	24	123-583-190	56	130-568-150	66	140-160-230	78
121-327-145	24	123-584-190	21	130-568-190	66	140-161-100	78
121-327-180	24	123-585-190	21	130-568-240	66	140-161-130	78
121-328-180	26	123-595-115	39	130-570-160	66	140-161-190	78
121-329-180	26	130-026-120	60	130-570-200	66	140-161-230	78
121-330-110	36	130-026-150	60	130-570-240	66	140-162-190	78
121-331-110	36	130-140-120	7, 63	130-572-160	66	140-221-425	79
121-331-150	36	130-140-150	63	130-572-200	66	140-221-426	79
121-332-150	40	130-151-180	63	130-572-240	66	140-255-125	7
121-332-180	40	130-239-150	68	130-719-150	70	140-258-090	79
121-332-200	40	130-242-120	68	130-720-150	70	140-258-125	79
121-334-190	20	130-242-150	68	130-736-175	72	140-259-090	79
121-334-230	20	130-243-120	68	130-736-200	72	140-259-125	79
121-335-190	20	130-243-150	68	130-737-175	72	140-262-125	79
121-335-230	20	130-490-100	60	130-737-200	72	140-263-125	79
121-336-190	20	130-491-100	60	130-738-180	71	140-267-140	80
121-337-185	20	130-492-100	60	130-738-210	71	140-270-120	78
121-339-127	44	130-500-100	60	130-738-250	71	140-271-120	78
121-342-190	22	130-501-100	60	130-738-300	71	140-281-140	7
121-343-190	22	130-502-100	60	130-740-120	70	140-291-140	5
121-344-170	22	130-503-100	61	130-740-145	71	140-293-140	7
121-344-190	22	130-504-100	61	130-740-180	71	140-295-160	5
121-344-230	22	130-505-100	61	130-740-210	71	140-311-185	7
121-345-170	22	130-510-250	5	130-740-250	71	140-318-130	78
121-345-190	22	130-511-110	60	130-740-300	71	140-318-140	78
121-345-230	22	130-512-150	65	130-741-180	71	140-318-160	78
121-575-145	32	130-513-110	61	130-741-210	71	140-319-130	78
122-296-110	37	130-516-170	66	130-741-250	71	140-319-140	78
122-297-110	37	130-518-145	65	130-741-300	71	140-319-160	78
122-311-180	27	130-518-160	65	130-743-250	70	140-331-200	5
122-411-135	45	130-518-170	67	130-746-120	70	140-332-200	5
122-561-140	42	130-518-180	65	130-747-145	71	140-333-140	7
122-576-170	28	130-520-150	67	130-747-180	71	140-338-140	78
122-577-170	28	130-522-145	68	130-747-210	71	140-361-280	5
122-594-115	39	130-522-150	66	130-747-250	71	140-573-090	7
122-595-115	39	130-522-160	68	130-747-300	71	140-573-110	7
123-031-170	50	130-522-180	68	130-748-180	71	140-573-130	5
123-037-170	50	130-524-150	67	130-748-210	71	140-630-190	5
123-070-115	41	130-524-180	67	130-748-250	71	150-052-250	5, 9
123-071-115	41	130-527-120	63	130-748-300	71	150-055-250	7
123-089-150	38	130-529-120	7, 67	130-749-180	70	260-150-325	196
123-111-145	48	130-529-150	67	130-749-230	70	165-064-160	222
123-111-180	48	130-532-120	65	130-750-150	11, 70	165-521-004	222
123-111-200	48	130-532-150	65	130-750-180	70	165-521-200	223
123-152-145	49	130-534-120	11, 67	130-750-230	70	165-522-130	7
123-153-145	49	130-534-150	67	130-751-150	70	165-522-200	223



Order number	Page	Order number	Page	Order number	Page	Order number	Page
165-523-110	222	170-227-215	5	180-548-230	85	210-488-007	117
165-523-112	222	170-237-175	93	180-549-150	85	210-488-008	117
165-525-006	222	170-275-175	96	180-549-180	85	210-488-009	117
165-525-007	9, 222	170-285-165	207	180-549-200	85	210-488-012	117
165-525-008	222	170-296-175	96	180-549-230	85	210-626-190	150
165-525-010	9, 222	170-457-102	206	180-550-125	85	210-722-210	150
165-525-012	222	170-459-001	208	180-550-140	85	210-790-180	9, 149
165-743-270	222	170-459-002	208	180-550-160	7, 85	210-792-230	149
260-810-000	236	170-459-003	208	180-550-180	85	210-844-170	150
166-970-010	235	170-510-130	97	180-550-200	85	210-845-185	150
166-970-011	235	170-512-160	11, 97	180-550-240	85	210-975-170	163
166-970-050	235	170-513-145	97	180-550-260	85	210-976-000	163
166-970-051	235	170-513-160	97	180-550-300	85	230-140-175	97
166-970-060	235	170-581-230	206	180-550-400	85	230-151-140	156
166-970-100	235	170-581-300	206	180-555-115	83	230-152-140	156
166-970-200	235	170-653-000	208	180-558-120	83	230-153-140	156
166-970-300	235	170-654-007	208	180-558-135	83	230-154-140	156
166-972-000	224	170-654-030	208	180-560-130	84	230-155-001	156
166-974-000	236	170-687-210	7	180-560-160	84	230-155-002	156
166-975-000	236	170-687-211	208	180-560-180	84	230-155-003	156
170-010-125	92	170-711-140	102	180-560-200	84	230-160-000	156
170-011-125	92	170-714-100	102	180-561-130	84	230-160-002	156
170-014-005	9	170-715-100	102	180-561-150	84	230-160-003	156
170-014-007	9	170-720-100	102	180-561-180	84	230-160-004	156
170-014-165	93	170-723-100	102	180-561-200	84	230-160-005	156
170-015-140	11, 92	170-749-105	102	180-561-230	84	230-160-006	156
170-019-000	93	170-750-105	102	180-562-270	5	230-160-007	156
170-020-000	93	170-879-175	95	180-567-170	87	230-160-008	156
170-020-001	93	171-130-165	98	180-567-190	87	230-160-175	97
170-020-002	93	171-483-025	207	180-568-120	83	230-190-175	97
170-020-003	93	171-483-138	207	180-568-140	85	230-195-175	96
170-020-100	93	171-591-330	7	180-568-170	85	230-202-000	148
170-021-115	92	171-593-300	207	180-568-180	85	230-202-001	148
170-031-120	94	171-891-215	207	180-569-120	83	230-202-002	148
170-033-120	94	171-891-300	207	180-569-130	87	230-203-002	92
170-034-120	94	180-335-170	88	180-569-180	87	230-203-102	92
170-036-180	9, 98	180-512-145	90	180-570-120	83	230-203-150	92
170-040-160	92	180-513-145	90	180-570-130	84	230-205-180	93
170-041-001	93	180-520-145	90	180-570-160	86	230-207-180	93
170-041-002	93	180-522-145	90	180-570-200	87	230-209-180	93
170-041-003	93	180-525-135	9, 86	180-571-150	87	230-210-170	148
170-041-004	93	180-530-120	7	180-588-150	86	230-211-170	148
170-042-130	94	180-531-150	86	180-648-180	88	230-230-140	157
170-042-160	11, 94	180-531-170	86	180-660-180	89	230-232-140	157
170-044-130	94	180-532-120	11, 83	180-661-150	89	230-236-140	157
170-044-160	94	180-533-130	84	180-661-180	89	230-238-100	157
170-079-002	95	180-534-140	86	180-661-190	89	230-239-100	157
170-079-003	95	180-536-130	11, 83	180-670-125	89	230-240-140	157
170-079-175	96	180-537-130	83	180-671-115	89	230-260-200	98
170-080-001	94	180-538-130	84	180-674-160	89	230-280-160	9, 95
170-080-002	94	180-539-130	84	180-675-160	89	230-281-140	96
170-081-135	94	180-540-150	85	180-755-150	88	230-282-140	96
170-085-130	95	180-540-180	5, 85	190-165-140	56	230-780-160	95
170-086-130	95	180-540-200	85	190-165-180	56	250-035-180	248
170-122-175	94	180-540-230	85	191-165-180	56	250-035-230	248
170-123-175	94	180-540-260	85	210-019-170	126	250-035-300	248
170-130-165	98	180-542-150	86	210-240-180	126	250-037-000	248
170-136-175	96	180-544-120	83	210-244-220	126	250-038-000	248
170-213-160	95	180-545-180	87	210-262-170	126	250-039-000	248
170-214-160	95	180-545-200	87	210-263-000	126	250-040-000	248
170-215-160	7	180-545-260	87	210-264-140	9, 126	250-041-000	248
170-216-160	7	180-548-150	85	210-265-000	126	250-042-000	248
170-220-004	5	180-548-180	85	210-488-004	117	250-044-000	248
170-220-006	5	180-548-200	85	210-488-006	117	250-045-000	248



INDEX

Numerical Index

Order number	Page	Order number	Page	Order number	Page	Order number	Page
250-048-000	248	260-012-193	100	260-070-916	193, 201	260-100-125	192, 200
250-048-180	248	260-012-194	100	260-070-925	193, 201	260-100-225	195, 200
250-048-230	248	260-012-195	100	260-080-016	191, 200	260-100-325	196, 200
250-048-300	248	260-012-198	99	260-080-025	191, 200	260-100-425	198, 201
250-051-000	248	260-012-199	210	260-080-116	192, 200	260-100-525	199, 201
250-052-000	248	260-012-200	210	260-080-125	192, 200	260-100-625	190, 200
250-059-000	248	260-012-201	210	260-080-216	195, 200	260-100-725	194, 200
250-264-246	90	260-012-202	210	260-080-225	195, 200	260-100-825	197, 201
250-264-247	90	260-012-205	209	260-080-316	196, 200	260-100-925	193, 201
251-010-000	142, 143, 144	260-012-210	101	260-080-325	196, 200	260-104-030	13, 174, 188
251-010-100	144	260-012-212	101	260-080-416	198, 201	260-105-030	174, 188
251-010-400	142, 143, 144	260-012-230	211	260-080-425	198, 201	260-110-000	188
251-140-175	174	260-012-398	99	260-080-516	199, 201	260-110-003	188
251-150-175	174	260-013-191	100	260-080-525	199, 201	260-110-030	188
251-340-175	174	260-013-192	99	260-080-616	190, 200	260-110-033	188
251-345-175	174	260-013-201	210	260-080-625	190, 200	260-110-125	192, 200
251-660-150	90	260-014-230	179	260-080-716	194, 200	260-110-225	195, 200
252-031-190	150	260-015-198	99	260-080-725	194, 200	260-110-325	196, 200
252-032-190	150	260-016-410	7, 213	260-080-816	197, 201	260-110-425	198, 201
260-001-001	175	260-020-000	177	260-080-825	197, 201	260-110-525	199, 201
260-001-002	175	260-020-001	176	260-080-916	193, 201	260-110-625	190, 200
260-001-013	211	260-020-038	99	260-080-925	193, 201	260-110-725	194, 200
260-001-101	13, 175	260-020-100	13, 177	260-088-370	7, 211	260-110-825	197, 201
260-001-102	13, 175	260-020-101	13, 176	260-090-016	191, 200	260-110-925	193, 201
260-001-201	175	260-020-200	177	260-090-024	191, 200	260-111-025	191
260-001-202	175	260-020-201	176	260-090-027	191, 200	260-118-150	97
260-001-250	209	260-021-000	178	260-090-030	191, 200	260-118-151	97
260-002-001	175	260-021-100	13, 178	260-090-116	192, 200	260-120-025	191, 200
260-002-002	179	260-021-200	178	260-090-124	192, 200	260-120-125	192, 200
260-002-003	176	260-022-000	178	260-090-127	192, 200	260-120-225	195, 200
260-002-005	180	260-022-100	13, 178	260-090-130	192, 200	260-120-325	196, 200
260-002-015	180	260-022-200	178	260-090-216	195, 200	260-120-425	198, 201
260-002-101	13, 175	260-023-000	176	260-090-224	195, 200	260-120-525	199, 201
260-002-103	176	260-023-100	13, 176	260-090-227	195, 200	260-120-625	190, 200
260-002-201	175	260-023-200	176	260-090-230	195, 200	260-120-725	194, 200
260-002-203	176	260-024-000	176	260-090-316	196, 200	260-120-825	197, 201
260-002-300	209	260-024-100	13, 176	260-090-324	196, 200	260-120-925	193, 201
260-003-001	177	260-024-200	176	260-090-327	196, 200	260-130-000	202
260-003-002	13, 179	260-025-000	177	260-090-330	196, 200	260-130-014	202
260-003-003	13, 179	260-025-100	13, 177	260-090-416	198, 201	260-130-015	202
260-003-101	13, 177	260-025-200	177	260-090-425	198, 201	260-130-016	191, 200
260-003-201	177	260-025-205	209	260-090-427	198, 201	260-130-110	206
260-004-001	177	260-026-100	179	260-090-430	198, 201	260-130-116	192, 200
260-004-101	13, 177	260-030-110	206	260-090-516	199, 201	260-130-160	202
260-004-201	177	260-037-000	204	260-090-524	199, 201	260-130-316	196, 200
260-006-001	180	260-039-000	204	260-090-527	199, 201	260-130-416	198, 201
260-007-001	175	260-070-016	191, 200	260-090-530	199, 201	260-130-516	199, 201
260-007-101	175	260-070-025	191, 200	260-090-616	190, 200	260-130-616	190, 200
260-007-201	175	260-070-116	192, 200	260-090-624	190, 200	260-130-716	194, 200
260-008-002	13, 180	260-070-125	192, 200	260-090-627	190, 200	260-130-816	197, 201
260-008-003	13, 180	260-070-216	195, 200	260-090-630	190, 200	260-130-916	193, 201
260-008-005	179	260-070-225	195, 200	260-090-716	194, 200	260-134-130	195, 200
260-008-007	179	260-070-316	196, 200	260-090-724	194, 200	260-135-000	203
260-009-000	211	260-070-325	196, 200	260-090-727	194, 200	260-135-004	203
260-010-000	7, 212	260-070-416	198, 201	260-090-730	194, 200	260-135-005	203
260-010-010	212	260-070-425	198, 201	260-090-816	197, 201	260-135-300	202
260-010-420	212	260-070-516	199, 201	260-090-824	197, 201	260-137-010	203
260-010-421	212	260-070-525	199, 201	260-090-827	197, 201	260-138-000	204
260-011-000	7, 213	260-070-616	190, 200	260-090-830	197, 201	260-140-000	213
260-011-010	213	260-070-625	190, 200	260-090-916	193, 201	260-140-420	213
260-011-420	213	260-070-716	194, 200	260-090-924	193, 201	260-145-000	203
260-011-421	213	260-070-725	194, 200	260-090-927	193, 201	260-145-250	203
260-012-191	100	260-070-816	197, 201	260-090-930	193, 201	260-150-016	191, 200
260-012-192	99	260-070-825	197, 201	260-100-025	191, 200	260-150-025	191, 200



Order number	Page	Order number	Page	Order number	Page	Order number	Page
260-150-030	191, 200	260-180-830	197, 201	260-311-000	213	260-751-236	216
260-150-036	191, 200	260-180-916	193, 201	260-311-420	213	260-751-250	216
260-150-116	192, 200	260-180-925	193, 201	260-400-310	211	260-753-040	217
260-150-125	192, 200	260-180-930	193, 201	260-400-315	7, 211	260-753-050	217
260-150-130	192, 200	260-190-025	191, 200	260-401-310	211	260-754-000	216
260-150-136	192, 200	260-190-036	191, 200	260-411-150	64	260-755-000	218
260-150-216	195, 200	260-190-125	192, 200	260-412-150	64	260-755-036	216
260-150-225	195, 200	260-190-136	192, 200	260-418-100	101	260-755-038	216
260-150-230	195, 200	260-190-225	195, 200	260-418-120	101	260-755-042	216
260-150-236	195, 200	260-190-236	195, 200	260-438-315	211	260-755-045	216
260-150-316	196, 200	260-190-325	196, 200	260-459-001	208	260-756-300	219
260-150-325	200	260-190-336	196, 200	260-459-002	208	260-757-000	218
260-150-330	196, 200	260-190-425	198, 201	260-459-003	208	260-761-000	217
260-150-336	196, 200	260-190-436	198, 201	260-500-001	9, 109	260-811-020	236
260-150-416	198, 201	260-190-525	199, 201	260-501-120	9, 101	260-811-124	236
260-150-425	198, 201	260-190-536	199, 201	260-501-180	13, 174	260-811-126	236
260-150-430	198, 201	260-190-625	190, 200	260-501-185	174	260-811-204	236
260-150-436	198, 201	260-190-636	190, 200	260-502-120	101	260-811-206	236
260-150-516	199, 201	260-190-725	194, 200	260-502-180	174	260-900-000	225
260-150-525	199, 201	260-190-736	194, 200	260-502-185	174	260-900-100	225
260-150-530	199, 201	260-190-825	197, 201	260-512-205	209	260-910-000	225
260-150-536	199, 201	260-190-836	197, 201	260-520-010	80	260-910-100	225
260-150-616	190, 200	260-190-925	193, 201	260-520-016	80	260-911-000	225
260-150-625	190, 200	260-190-936	193, 201	260-520-020	80	260-911-100	225
260-150-630	190, 200	260-200-110	101	260-520-026	80	260-912-150	226
260-150-636	190, 200	260-202-101	178	260-591-300	207	260-912-151	226
260-150-716	194, 200	260-202-103	178	260-600-100	185	260-912-152	229
260-150-725	194, 200	260-202-105	178	260-603-380	209	260-912-153	229
260-150-730	194, 200	260-203-600	13, 181	260-603-450	209	260-912-202	229
260-150-736	194, 200	260-203-700	13, 181	260-604-100	185	260-912-203	229
260-150-816	197, 201	260-203-800	13, 181	260-608-100	185	260-912-252	229
260-150-825	197, 201	260-204-100	181	260-610-100	185	260-912-253	229
260-150-830	197, 201	260-204-200	181	260-614-100	185	260-912-302	229
260-150-836	197, 201	260-204-300	13, 181	260-615-100	185	260-912-303	229
260-150-916	193, 201	260-204-327	181	260-700-000	13, 186	260-913-150	226
260-150-925	193, 201	260-204-400	13, 181	260-700-100	187	260-913-151	226
260-150-930	193, 201	260-204-427	181	260-700-102	187	260-913-152	229
260-150-936	193, 201	260-204-500	181	260-700-103	187	260-913-153	229
260-180-016	191, 200	260-204-600	13, 181	260-700-104	187	260-913-200	226
260-180-025	191, 200	260-204-627	181	260-700-105	187	260-913-201	226
260-180-030	191, 200	260-210-130	100	260-700-112	187	260-913-202	229
260-180-116	192, 200	260-220-025	191, 200	260-700-114	187	260-913-203	229
260-180-125	192, 200	260-220-125	192, 200	260-702-000	13, 186	260-913-250	226
260-180-130	192, 200	260-220-225	195, 200	260-710-000	7, 186	260-913-251	226
260-180-216	195, 200	260-220-325	196, 200	260-711-110	102	260-913-252	229
260-180-225	195, 200	260-220-425	198, 201	260-712-000	7, 186	260-913-253	229
260-180-230	195, 200	260-220-525	199, 201	260-737-040	213	260-913-300	226
260-180-316	196, 200	260-220-625	190, 200	260-738-000	7, 218	260-913-301	226
260-180-325	196, 200	260-220-725	194, 200	260-742-000	7, 218	260-913-302	229
260-180-330	196, 200	260-220-825	197, 201	260-745-000	7, 218	260-913-303	229
260-180-416	198, 201	260-220-925	193, 201	260-746-000	217	260-914-152	229
260-180-425	198, 201	260-230-019	191	260-750-125	216	260-914-153	229
260-180-430	198, 201	260-230-110	206	260-750-130	216	260-914-200	226
260-180-516	199, 201	260-233-145	80	260-750-134	216	260-914-201	226
260-180-525	199, 201	260-234-145	80	260-750-136	216	260-914-202	229
260-180-530	199, 201	260-244-150	7	260-750-138	7, 216	260-914-203	229
260-180-616	190, 200	260-267-155	80	260-750-140	216	260-914-250	226
260-180-625	190, 200	260-267-260	80	260-750-142	7, 216	260-914-251	226
260-180-630	190, 200	260-268-310	80	260-750-145	7, 216	260-914-252	229
260-180-716	194, 200	260-268-410	80	260-750-150	216	260-914-253	229
260-180-725	194, 200	260-293-300	202	260-750-152	216	260-914-300	226
260-180-730	194, 200	260-310-000	212	260-751-125	216	260-914-301	226
260-180-816	197, 201	260-310-270	164	260-751-142	216	260-914-302	229
260-180-825	197, 201	260-310-420	212	260-751-225	216	260-914-303	229



INDEX

Numerical Index

Order number	Page	Order number	Page	Order number	Page	Order number	Page
260-915-152	229	260-924-300	226	260-935-250	227	260-945-302	233
260-915-153	229	260-924-301	226	260-935-251	227	260-945-303	233
260-915-200	226	260-924-302	230	260-935-252	231	260-946-152	233
260-915-201	226	260-924-303	230	260-935-253	231	260-946-153	233
260-915-202	229	260-925-152	230	260-935-300	227	260-946-202	233
260-915-203	229	260-925-153	230	260-935-301	227	260-946-203	233
260-915-250	226	260-925-202	230	260-935-302	231	260-946-252	233
260-915-251	226	260-925-203	230	260-935-303	231	260-946-253	233
260-915-252	229	260-925-250	226	260-936-152	231	260-946-302	233
260-915-253	229	260-925-251	226	260-936-153	231	260-946-303	233
260-915-300	226	260-925-252	230	260-936-202	231	260-952-150	227
260-915-301	226	260-925-253	230	260-936-203	231	260-952-151	227
260-915-302	229	260-925-300	226	260-936-252	231	260-952-152	232
260-915-303	229	260-925-301	226	260-936-253	231	260-952-153	232
260-916-152	229	260-925-302	230	260-936-302	231	260-952-202	232
260-916-153	229	260-925-303	230	260-936-303	231	260-952-203	232
260-916-200	226	260-926-152	230	260-942-150	228	260-952-252	232
260-916-201	226	260-926-153	230	260-942-151	228	260-952-253	232
260-916-202	229	260-926-202	230	260-942-152	233	260-952-302	232
260-916-203	229	260-926-203	230	260-942-153	233	260-952-303	232
260-916-250	226	260-926-252	230	260-942-202	233	260-953-150	227
260-916-251	226	260-926-253	230	260-942-203	233	260-953-151	227
260-916-252	229	260-926-302	230	260-942-252	233	260-953-152	232
260-916-253	229	260-926-303	230	260-942-253	233	260-953-153	232
260-916-300	226	260-932-150	227	260-942-302	233	260-953-200	227
260-916-301	226	260-932-151	227	260-942-303	233	260-953-201	227
260-916-302	229	260-932-152	231	260-943-150	228	260-953-202	232
260-916-303	229	260-932-153	231	260-943-151	228	260-953-203	232
260-922-150	226	260-932-202	231	260-943-152	233	260-953-250	227
260-922-151	226	260-932-203	231	260-943-153	233	260-953-251	227
260-922-152	230	260-932-252	231	260-943-200	228	260-953-252	232
260-922-153	230	260-932-253	231	260-943-201	228	260-953-253	232
260-922-202	230	260-932-302	231	260-943-202	233	260-953-302	232
260-922-203	230	260-932-303	231	260-943-203	233	260-953-303	232
260-922-252	230	260-933-152	231	260-943-250	228	260-954-152	232
260-922-253	230	260-933-153	231	260-943-251	228	260-954-153	232
260-922-302	230	260-933-200	227	260-943-252	233	260-954-200	227
260-922-303	230	260-933-201	227	260-943-253	233	260-954-201	227
260-923-150	226	260-933-202	231	260-943-302	233	260-954-202	232
260-923-151	226	260-933-203	231	260-943-303	233	260-954-203	232
260-923-152	230	260-933-250	227	260-944-152	233	260-954-250	227
260-923-153	230	260-933-251	227	260-944-153	233	260-954-251	227
260-923-200	226	260-933-252	231	260-944-200	228	260-954-252	232
260-923-201	226	260-933-253	231	260-944-201	228	260-954-253	232
260-923-202	230	260-933-302	231	260-944-202	233	260-954-300	227
260-923-203	230	260-933-303	231	260-944-203	233	260-954-301	227
260-923-250	226	260-934-152	231	260-944-250	228	260-954-302	232
260-923-251	226	260-934-153	231	260-944-251	228	260-954-303	232
260-923-252	230	260-934-200	227	260-944-252	233	260-955-152	232
260-923-253	230	260-934-201	227	260-944-253	233	260-955-153	232
260-923-300	226	260-934-202	231	260-944-300	228	260-955-202	232
260-923-301	226	260-934-203	231	260-944-301	228	260-955-203	232
260-923-302	230	260-934-250	227	260-944-302	233	260-955-250	227
260-923-303	230	260-934-251	227	260-944-303	233	260-955-251	227
260-924-152	230	260-934-252	231	260-945-152	233	260-955-252	232
260-924-153	230	260-934-253	231	260-945-153	233	260-955-253	232
260-924-200	226	260-934-300	227	260-945-202	233	260-955-300	227
260-924-201	226	260-934-301	227	260-945-203	233	260-955-301	227
260-924-202	230	260-934-302	231	260-945-250	228	260-955-302	232
260-924-203	230	260-934-303	231	260-945-251	228	260-955-303	232
260-924-250	226	260-935-152	231	260-945-252	233	260-956-152	232
260-924-251	226	260-935-153	231	260-945-253	233	260-956-153	232
260-924-252	230	260-935-202	231	260-945-300	228	260-956-202	232
260-924-253	230	260-935-203	231	260-945-301	228	260-956-203	232

Order number	Page	Order number	Page	Order number	Page	Order number	Page
260-956-252	232	260-981-250	224	310-022-140	79	420-119-003	133
260-956-253	232	260-981-300	224	400-018-005	60	420-120-150	131
260-956-302	232	260-982-150	224	400-022-090	62	420-122-150	131
260-956-303	232	260-982-200	224	400-025-110	64	420-123-150	131
260-962-150	228	260-982-250	224	400-029-012	64	420-124-029	132
260-962-151	228	260-982-300	224	400-082-100	61	420-124-033	132
260-962-152	234	260-983-200	224	400-083-100	61	420-124-037	132
260-962-153	234	260-983-300	224	400-084-100	64	420-132-035	140
260-962-202	234	260-984-150	224	400-118-005	61	420-132-055	140
260-962-203	234	260-984-200	224	400-137-003	62	420-132-075	140
260-962-252	234	260-984-201	224	400-137-012	62	420-132-090	140
260-962-253	234	260-984-250	224	400-137-021	62	420-134-050	138
260-962-302	234	260-984-300	224	400-137-030	11, 62	420-135-035	140
260-962-303	234	260-984-301	224	400-137-031	62	420-135-055	140
260-963-150	228	260-985-150	224	400-137-050	62	420-135-075	140
260-963-151	228	260-985-200	224	400-137-055	62	420-135-090	140
260-963-152	234	260-985-250	224	400-137-150	62	420-136-020	138
260-963-153	234	260-985-301	224	400-139-050	62	420-136-035	138
260-963-200	228	260-990-001	5	400-348-135	90	420-136-055	138
260-963-201	228	260-990-002	7	400-350-135	90	420-136-070	138
260-963-202	234	260-990-003	9	400-420-100	218	420-136-080	138
260-963-203	234	260-990-004	11	400-421-000	218	420-136-090	138
260-963-250	228	260-990-005	13	400-583-007	218	420-138-040	137
260-963-251	228	260-990-999	202	400-583-008	218	420-138-055	9, 137
260-963-252	234	290-552-160	63	400-602-267	11	420-138-075	137
260-963-253	234	290-850-160	72	400-832-100	217	420-138-090	137
260-963-302	234	290-850-200	72	400-850-240	102	420-139-035	137
260-963-303	234	290-850-240	72	400-850-255	11, 102	420-139-055	137
260-964-152	234	290-850-300	72	400-850-265	102	420-139-075	137
260-964-153	234	290-851-160	72	410-033-100	164	420-140-035	142
260-964-200	228	290-851-200	72	410-033-130	164	420-140-050	142
260-964-201	228	290-851-240	72	410-033-131	164	420-140-075	142
260-964-202	234	290-851-300	72	410-033-132	164	420-140-090	142
260-964-203	234	290-852-160	72	410-033-133	164	420-140-100	142
260-964-250	228	290-852-200	72	410-391-140	61	420-140-135	134
260-964-251	228	290-852-240	72	410-395-190	9, 61	420-141-040	136
260-964-252	234	290-852-300	72	410-396-190	61	420-141-055	136
260-964-253	234	290-853-160	72	410-404-030	222	420-141-075	136
260-964-300	228	290-853-200	72	410-404-035	222	420-141-090	136
260-964-301	228	290-853-240	72	410-404-040	222	420-142-135	134
260-964-302	234	290-853-300	72	420-050-001	128	420-143-040	136
260-964-303	234	290-854-160	72	420-050-002	128	420-143-055	136
260-965-152	234	290-854-200	72	420-050-003	128	420-143-075	136
260-965-153	234	290-854-240	72	420-050-004	128	420-143-090	136
260-965-202	234	290-854-300	72	420-050-005	128	420-144-040	136
260-965-203	234	300-001-600	244	420-050-006	128	420-144-055	136
260-965-250	228	300-001-601	244	420-050-007	128	420-144-075	136
260-965-251	228	300-001-602	245	420-050-101	128	420-144-090	136
260-965-252	234	300-001-610	243, 245	420-050-102	128	420-146-040	139
260-965-253	234	300-001-616	243, 245	420-050-103	128	420-146-055	139
260-965-300	228	300-001-800	242	420-050-104	128	420-146-075	139
260-965-301	228	300-001-802	243	420-050-105	128	420-146-090	139
260-965-302	234	300-001-804	242	420-050-106	128	420-146-152	135
260-965-303	234	300-750-101	184	420-050-107	128	420-146-153	135
260-966-152	234	300-750-103	184	420-052-001	129	420-147-040	139
260-966-153	234	300-750-105	184	420-052-002	129	420-147-055	139
260-966-202	234	300-750-106	184	420-052-003	129	420-147-075	139
260-966-203	234	300-860-100	76	420-052-004	129	420-147-090	139
260-966-252	234	300-860-111	76	420-057-160	153	420-147-140	135
260-966-253	234	300-900-180	247	420-100-001	130	420-148-040	136
260-966-302	234	300-900-300	246	420-100-002	130	420-148-055	136
260-966-303	234	310-012-150	7	420-100-003	130	420-148-075	136
260-981-150	224	310-014-150	5, 79	420-119-001	133	420-148-090	136
260-981-200	224	310-014-190	79	420-119-002	133	420-148-150	134



INDEX

Numerical Index

Order number	Page	Order number	Page	Order number	Page	Order number	Page
420-150-001	143	420-455-230	149	420-496-210	105	420-580-002	112
420-150-002	143	420-459-001	115	420-496-230	104	420-580-003	112
420-150-003	143	420-459-002	9	420-497-165	104	420-580-004	112
420-150-004	143	420-459-002	115	420-497-210	105	420-580-007	112
420-150-005	143	420-459-003	9	420-497-230	104	420-580-009	112
420-150-006	143	420-459-003	115	420-498-004	114	420-580-012	112
420-150-007	143	420-459-101	115	420-498-006	114	420-580-145	171
420-150-008	143	420-459-102	115	420-498-008	114	420-581-140	171
420-150-101	142	420-459-103	115	420-498-165	104	420-582-003	117
420-150-102	142	420-460-004	114	420-498-210	105	420-582-045	117
420-150-105	142	420-460-005	114	420-498-230	104	420-582-140	171
420-150-106	142	420-480-200	105	420-499-165	104	420-583-145	171
420-150-107	142	420-481-215	146	420-499-210	105	420-585-160	146
420-150-108	142	420-485-005	115	420-500-165	104	420-587-008	114
420-150-150	134	420-486-005	115	420-500-200	112	420-587-010	114
420-150-201	144	420-487-005	115	420-501-002	113	420-587-012	114
420-150-202	144	420-487-009	116	420-501-004	113	420-587-014	114
420-150-203	144	420-487-011	116	420-501-006	113	420-587-016	114
420-150-204	144	420-487-013	116	420-501-008	113	420-589-008	114
420-150-205	144	420-487-015	116	420-501-010	113	420-589-010	114
420-150-206	144	420-488-009	116	420-501-012	113	420-589-012	114
420-150-301	143	420-488-011	116	420-501-015	113	420-589-014	114
420-150-302	143	420-488-013	116	420-502-002	117	420-589-016	114
420-183-150	7	420-488-015	116	420-502-003	118	420-594-002	112
420-184-100	101	420-488-200	105	420-502-005	118	420-594-003	112
420-185-100	101	420-490-005	114	420-502-007	118	420-594-004	112
420-189-210	147	420-490-007	114	420-502-010	118	420-594-005	112
420-190-003	148	420-490-009	114	420-502-015	118	420-594-006	112
420-190-160	7	420-490-011	114	420-502-018	118	420-594-008	112
420-191-003	9, 148	420-490-013	114	420-502-210	118	420-594-009	112
420-195-150	164	420-490-210	105	420-502-211	118	420-594-010	112
420-205-160	9, 164	420-491-000	115	420-502-215	118	420-594-011	112
420-220-212	149	420-491-001	115	420-502-216	118	420-594-012	112
420-220-220	149	420-491-002	115	420-503-011	112	420-594-015	112
420-221-200	149	420-491-165	104	420-505-005	116	420-639-001	115
420-235-110	152	420-491-210	105	420-505-007	116	420-639-002	115
420-236-110	152	420-491-230	104	420-505-009	116	420-639-003	115
420-237-095	152	420-492-003	117	420-505-011	116	420-640-001	115
420-237-195	152	420-492-004	117	420-505-016	116	420-640-002	115
420-238-095	152	420-492-005	117	420-507-010	113	420-640-003	115
420-238-195	152	420-492-006	117	420-520-140	97	420-650-001	108
420-239-090	152	420-492-165	104	420-520-141	97	420-650-002	108
420-239-095	152	420-492-210	105	420-520-170	109	420-650-050	107
420-239-190	152	420-492-230	104	420-521-170	109	420-650-100	9, 107
420-239-195	152	420-493-165	104	420-523-140	97	420-650-101	107
420-250-160	9, 153	420-493-210	105	420-523-141	97	420-652-100	152
420-252-185	223	420-493-230	104	420-530-165	9, 146	420-653-000	107
420-253-185	223	420-494-002	116	420-531-165	146	420-654-180	108
420-255-160	153	420-494-004	116	420-532-165	146	420-655-180	108
420-257-160	152	420-494-006	116	420-532-200	9, 147	420-656-180	108
420-310-190	223	420-494-008	116	420-550-230	9, 146	420-657-180	108
420-364-000	151	420-494-010	116	420-551-170	117	420-660-000	107
420-365-000	9	420-494-012	116	420-551-200	147	420-660-100	109
420-365-000	151	420-494-014	116	420-551-210	147	420-660-101	109
420-366-000	151	420-494-165	104	420-552-170	117	420-660-102	109
420-367-000	151	420-494-210	105	420-552-215	9, 148	420-660-103	109
420-392-003	148	420-494-230	104	420-553-170	146	420-660-104	109
420-392-004	148	420-495-003	113	420-555-195	147	420-660-105	109
420-392-005	148	420-495-004	113	420-557-170	147	420-660-106	109
420-395-205	9	420-495-005	113	420-568-002	9, 113	420-660-107	109
420-395-205	223	420-495-165	104	420-568-004	9, 113	420-660-108	109
420-450-230	149	420-495-210	105	420-568-006	9, 113	420-660-109	109
420-451-230	149	420-495-230	104	420-568-008	113	420-660-110	109
420-452-230	149	420-496-165	104	420-568-010	113	420-660-150	109

Order number	Page	Order number	Page	Order number	Page	Order number	Page
420-660-200	109	430-105-003	170	510-332-150	160	700-040-200	74
420-660-214	9, 105	430-297-140	205	510-334-140	163	700-040-220	74
420-660-216	105	430-297-150	205	510-338-150	161	700-041-150	74
420-660-218	9, 105	430-397-140	205	510-347-130	160	700-041-180	74
420-660-219	105	430-397-150	205	510-377-160	161	700-041-200	74
420-660-220	105	430-497-141	205	510-425-090	163	700-041-220	74
420-660-500	109	430-497-151	205	510-460-000	163	700-042-150	74
420-661-000	107	430-531-170	148	510-460-001	163	700-042-180	74
420-661-100	107	430-532-170	148	510-460-002	163	700-042-200	74
420-662-001	107	430-797-140	205	510-460-003	163	700-042-220	74
420-662-002	107	430-797-141	205	510-462-130	162	700-043-150	74
420-668-210	107	430-797-150	205	510-463-140	162	700-043-180	74
420-669-210	107	430-797-151	205	510-464-140	162	700-043-200	74
420-670-210	108	430-797-155	206	600-279-261	167	700-043-220	74
420-672-000	9, 107	431-200-001	171	700-010-150	74	700-050-150	75
420-672-004	107	431-200-003	171	700-010-180	74	700-050-180	75
420-677-210	107	431-200-011	171	700-010-200	74	700-050-200	75
420-678-190	109	431-200-013	171	700-010-220	74	700-050-220	75
420-690-200	108	431-200-021	171	700-011-150	74	700-052-150	75
420-691-200	108	431-200-023	171	700-011-180	74	700-052-180	75
420-692-200	108	431-200-027	171	700-011-200	74	700-052-200	75
420-700-001	122	431-200-100	170	700-011-220	74	700-052-220	75
420-700-002	122	431-630-006	146	700-012-150	74	700-060-150	75
420-700-020	122	431-630-007	146	700-012-180	74	700-060-180	75
420-700-022	122	431-630-009	146	700-012-200	74	700-060-200	75
420-700-025	122	431-630-011	146	700-012-220	74	700-060-220	75
420-700-030	122	431-643-008	119	700-013-150	74	700-062-150	75
420-700-100	122	431-643-011	119	700-013-180	74	700-062-180	75
420-700-120	122	431-645-007	119	700-013-200	74	700-062-200	75
420-700-140	122	431-645-008	119	700-013-220	74	700-062-220	75
420-700-200	123	431-645-010	119	700-020-150	74	700-070-150	75
420-700-210	122	431-645-012	119	700-020-180	74	700-070-180	75
420-700-330	123	431-645-016	119	700-020-200	74	700-070-200	75
420-700-340	124	431-646-008	119	700-020-220	74	700-070-220	75
420-700-400	123	431-646-012	119	700-021-150	74	700-072-150	75
420-700-430	122	431-646-016	119	700-021-180	74	700-072-180	75
420-700-501	123	431-662-190	114	700-021-200	74	700-072-200	75
420-700-502	123	431-666-190	114	700-021-220	74	700-072-220	75
420-700-610	124	431-668-190	114	700-022-150	74	700-080-150	75
420-700-611	124	503-003-000	157, 159	700-022-180	74	700-080-180	75
420-700-620	124	503-005-000	159, 161	700-022-200	74	700-080-200	75
420-700-630	124	503-007-000	159	700-022-220	74	700-080-220	75
420-700-640	124	503-008-000	158	700-023-150	74	700-082-150	75
420-700-650	124	503-009-000	158	700-023-180	74	700-082-180	75
420-700-700	123	503-011-000	158	700-023-200	74	700-082-200	75
420-743-040	141	503-013-000	158	700-023-220	74	700-082-220	75
420-743-055	141	503-015-000	158	700-030-150	74	700-100-101	76
420-743-075	141	503-022-015	158	700-030-180	74	700-100-102	76
420-743-090	141	503-023-000	158	700-030-200	74	700-100-103	76
420-752-100	152	510-050-100	163	700-030-220	74	700-100-130	76
420-756-180	108	510-050-120	163	700-031-150	74	700-100-150	76
420-832-000	217	510-205-115	160	700-031-180	74	700-101-001	76
420-832-001	217	510-210-140	161	700-031-200	74	700-101-030	76
420-832-145	217	510-215-140	161	700-031-220	74	700-101-050	76
420-985-013	172	510-220-100	162	700-032-150	74	700-101-130	76
420-985-014	172	510-224-140	160	700-032-180	74	700-101-150	76
420-985-015	172	510-225-140	160	700-032-200	74	700-101-230	76
430-100-600	170	510-225-142	160	700-032-220	74	700-101-250	76
430-100-601	170	510-226-140	160	700-033-150	74	700-102-030	76
430-100-602	170	510-226-142	160	700-033-180	74	700-103-030	76
430-100-603	170	510-227-140	160	700-033-200	74	700-103-050	76
430-100-604	170	510-245-100	162	700-033-220	74	700-104-050	76
430-105-001	170	510-250-110	162	700-040-150	74	700-105-030	76
430-105-002	170	510-251-130	162	700-040-180	74	700-200-130	76



<u>Order number</u>	<u>Page</u>	<u>Order number</u>	<u>Page</u>	<u>Order number</u>	<u>Page</u>	<u>Order number</u>	<u>Page</u>
700-200-132	76	700-400-003	76				
700-200-150	76	700-400-030	76				
700-200-152	76	700-400-035	76				
700-280-030	76	700-400-036	76				
700-280-050	76	700-400-040	76				
700-285-030	76	700-400-041	76				
700-285-050	76	700-400-050	76				
700-286-030	76	700-400-055	76				
700-286-050	76	700-400-103	76				
700-286-130	76	700-400-105	76				
700-286-230	76	700-400-130	76				
700-287-030	76	700-400-203	76				
700-287-050	76	700-400-230	76				
700-287-130	76	700-400-250	76				
700-287-150	76	700-400-303	76				
700-287-230	76	700-400-330	76				
700-287-250	76	700-400-350	76				
700-290-030	76	700-400-403	76				
700-290-050	76	700-400-430	76				
700-291-030	76	700-400-450	76				
700-291-050	76	700-400-530	76				
700-292-030	76	700-400-550	76				
700-293-033	76	700-500-300	241				
700-293-030	76	700-500-500	241				
700-293-035	76	700-501-300	241				
700-300-003	76	700-501-302	76				
700-300-005	76	700-501-303	76				
700-300-203	76	700-501-500	241				
700-300-205	76	700-501-502	76				
700-300-403	76	700-501-503	76				
700-300-405	76	700-503-003	241				
700-345-003	76	700-504-000	241				
700-345-005	76	700-801-100	241				
700-345-403	76	700-801-900	241				
700-345-405	76						
700-350-030	76						
700-350-050	76						
700-350-130	76						
700-350-150	76						
700-350-400	240						
700-350-404	241						
700-350-405	241						
700-350-410	240						
700-350-420	240						
700-350-430	240						
700-351-030	76						
700-351-031	76						
700-351-050	76						
700-351-051	76						
700-351-131	76						
700-351-151	76						
700-351-231	76						
700-351-251	76						
700-360-031	76						
700-360-051	76						
700-361-030	76						
700-361-050	76						
700-362-030	76						
700-362-050	76						
700-363-030	76						
700-363-050	76						
700-364-030	76						
700-370-030	76						
700-370-050	76						

Description	Page
Accessories	239-249
Adaptor	202, 224, 236, 248
ADSON	
Forceps	60, 63, 65, 67, 70, 124
Suction Cannula	222
ADSON-BROWN Tissue Forceps	67, 124
ADSON-DEBAKEY Atraumatic Forceps	63
AGRIS-DINGMAN Transaxillary Dissector Set	211
ALLIS Forceps	79
ALM Self Retaining Retractor	102
ANDERSON Retractor	101
ANDERSON-NEIVERT Osteotome	115
Areola Marker	216, 217
ASH Septum Straightening Forceps	149
ASTON	
Rasp	105
Scissors	29
Atraumatic Forceps	63, 66, 72
AUFRICHT	
Nasal Rasp	108
Nasal Retractor	123, 153
Scissors	32
AUFRICHT (PEET) Nasal Rasp	106
BABY CRILE-WOOD TC Needle Holder	86
BABY SENN-MILLER Retractor	95
BABY-METZENBAUM Scissors	47
BALLENGER	
Scalpel Handle	159
Swivel Knife	148
BARRON Scalpel Handle	159
BARRQUER Micro Needle Holder	90
BARSKY Double Skin Hook	93
BARSKY-GLABELLA Nasal Rasp	108
BEASLEY-BABCOCK Tissue Forceps	64
BECKMANN Nasal Speculum	135
BERRY Wire Holding Forceps	87
BEUSE Nasal Scissors	45
BEUSE-JOSEPH Dissecting Scissors	42
BEYER Bone Rongeur	149
Bipolar Cable	76, 241
Bipolar Forceps	73-76
BISHOP-HARMON Forceps	60, 61
BLAKESLEY Nasal Forceps	123
Blepharoplasty Scissors	36, 52
BOETTCHER Scissors	35
BOETTLER (Kaye pattern) Super-Cut Facelift Scissors	32
BOIES Elevator	147
Bone Crusher	151
Bone Cutting Forceps	150
Bone Holding Forceps	150
Bone Rongeur	149
BONN Scissors	43
BRAITHWAITE (MODIF. HUMBY) Hand Dermatome	165
BRAITHWAITE Nasal Chisel	115
BROWN Tissue Forceps	63
BUCK-GRAMCKO Retractor	96
Bulldog Clamp	79
Button end Knife	164
BYRD Breast Dissector	211
Cable	
Bipolar	76, 241
Monopolar	76, 241
Xenon Fibre Optic Light Guide Cable	248
Caliper	218, 219

Description	Page
Camera	244, 242
Cannula	
Infiltration	224
Injection	236
Liposuction	226-228
Suction	222
CANNY-RYALL Retractor	208
CAPLAN Nasal Scissors	46
Capsulotomy Knife	164
CARTER Septum Elevator	147
Cartilage Crusher	151
CASTANARES Scissors	33
CASTROVIEJO	
Caliper	218
Forceps	62
Micro Needle Holder	90
Chisel	115-117
CINELLI Osteotome	114
Clamp, Bulldog	79
Cleft Palate Instruments	169-172
CLOWARD Skin Hook	93
COBRA Liposuction Cannula/ Instrument	227, 232
CONVERSE	
Needle Holder	83
Retractor	101, 152
Coronal Brow Lift Retractor	210
COTTLE	
Bone Crusher	151
Chisel	116, 117
Elevator	146
Mallet	126
Nasal Rasp	108
Nasal Speculum	140, 141
Retractor	96, 97
Scissors	46
COTTLE-KAZANJIAN Bone Cutting Forceps	150
COTTLE-MASING Nasal Speculum	142
COTTLE-NEIVERT Alar Retractor	98
COTTLE-WALSHAM Septum Straightening Forceps	149
COX Ocular Shield	102
CRILE-WOOD Needle Holder	85
CRONIN Cleft Palate Knife	170
Curette	156, 158
CUSHING	
Forceps	65, 72
Skin Hook	92
CUSHING-TAYLOR Forceps	66
Cuticle and tissue nipper	162
Cutting Forceps	150
CZERNY Retractor	208
D'ASSUMPCAO Face Lift Forceps	80
DANIELS Nasal Scissors	45
DAVIS Scissors	35
DEAVER Retractor	202, 206, 207
DEBAKEY	
Forceps	63, 66, 72
Needle Holder	85, 88, 89
DERF Needle Holder	83, 89
Dermatology Instruments	155-168
Dermatome	165
DESMARRES Lid Retractor	97
Devices	250-268
DEVINE-MILLARD-AUFRICHT Nasal Retractor	152, 153
DIETRICH-DEBAKEY Micro Bulldog Clamp	79



Description	Page
DINGMAN Otopraders	164
DINGMAN Bone Holding Forceps	150
Dissecting Forceps	65, 78, 185
Dissecting Scissors	40-43, 48, 49, 54, 57, 124
Dissector	171, 175-179, 211-213, 223
Dressing Forceps	60, 65, 66, 68, 71, 72, 124
ECKHOFF Skin Marking Pen	217
Electrode	186, 187
Electrode Handle	187
Elevator	
Breast	211
Cleft Palate	170, 171
Endoforehead	178
Periost / Periosteal	122, 146, 170, 179
Septum	147
Suction	180, 223
others	146-148, 158, 175, 176, 178
Enderectomy Dissecting Scissors	44
Endoscope	188
Endoscopic Instruments	183-188
EPKER Osteotome	114
Facelift Scissors	20-35
FANOUS-GUBISCH Osteotome	115
FARR Retractor Wire	102
FERGUSON Suction Tube	222
FERREIRA Facelift Retractor	206
FERREIRA STYLE Breast Retractor	190-193
FOERSTER Capsulotomy Knife	164
FOMON	
Rasp	105-107, 109
Retractor	95
Scissors	44
SET	109
FOMON-SABER Scissors	34
Footswitch	241, 243, 245
Forceps	59-68 / 77-80
Atraumatic Forceps	63, 66, 72
Bipolar Forceps	74, 75
Cutting Forceps	150
Dissecting Forceps	65, 78, 185
Dressing Forceps	60, 65, 66, 68, 71, 72, 124
Grasping Forceps	79, 80, 181, 185
Hemostatic Forceps	78, 79
Hook Forceps	64
Monopolar Forceps	70-72
Nasal Forceps	61, 123, 150
Suture Forceps	62
Tissue Forceps	61-64, 67, 68, 70, 71, 79, 124
FOSTER-GILLIES Needle Holder	83
FOX Lupus Curette	156
FREEMAN	
Areola Marker	216
Retractor	99, 100, 209, 210
FREEMAN-ADAMSON Face Lift Retractor	100
FREER Mucosa Knife	164
FRENCH (GILLIES) Osteotome	114
FRENCHAY Osteotome	115
FRIEDMAN Nasal Rasp	107
FROST	
Elevator	158
Probe-Excavator	158
Spatula Packer	158
GABARRO Skin Graft Measure	165
GALLAHER Nasal Rasp	109

Description	Page
GALVAO Areola Marker	217
Generator	240
GERALD Forceps	63, 66, 67, 70
GILLIES	
Forceps	67, 70
Needle Holder	86
Skin Hook	93
GLABELLA Rasp	106, 123
GOLDMAN-FOX Scissors	36
GOLDMANN Septum elevator	147
GORNEY	
Rake Retractor	99
Scissors	20, 21, 46
Septal Morselizer	149
Suction Respiratory	223
GORNEY-FREEMAN Scissors	22, 23
GOULIAN Hand Dermatome	165
GRADLE Scissors	41
GRADLE-WALTON Scissors	52
GRAEFE	
Forceps	60, 61, 64
Skin Hook	92, 93, 122
Grasping Forceps	79, 80, 181, 185
GREEN Forceps	64
GREENBERG-PAR Scissors	38
GREGORY Scissors	34
GROSSMANN Areola Marker	216
GUILEN Suction Elevator	223
GUINTA Nasal Scissors	45
GUNTER Lower Lateral Morselizer	149
GUTHRIE Wound Retractor	94
HAJEK	
Abdominal Retractor	207
Mallet	126
HALLE-TIECK Nasal Speculum	134
HALPERN Breast Caliper	218
HALSEY Needle Holder	83, 89, 123
HALSTEAD-MOSQUITO Titanium Hemostatic Forceps	79
Handle	
Electrode Handle	187
Laparoscopic Handle	184
Lipo-Injection-Dosing-Handle	236
Scalpel Handle	159
HARTMANN	
Nasal Speculum	133
Hemostatic Forceps	79
HARTMANN-HALLE MOD. SONNENSCHN Nasal Speculum	134
HARTMANN-HALLE Nasal Speculum	131, 132
HEANEY Retractor	208
HEANEY-SIMON Abdominal Retractor	206
HEGAR-BAUMGARTNER TC Needle Holder	86
Hemostatic Forceps	78, 79
HEYMANN Nasal Scissors	46
Hook	92, 93, 96, 101, 122, 171, 179, 208
Hook Forceps	64
Hook Scissors	181, 185
HOWARTH Elevator	148
Infiltration Cannulas	224
Injection Cannula	236
IRIS Scissors	41, 53, 51
JABALEY Super-Cut Scissors	53
JABOMA Cleft Palate Periosteal Elevator	170

Description	Page
JACOBSON	
Hemostatic Forceps	78
Micro Needle Holder	90
JAMESON	
Caliper	218
Super-Cut Scissors	38
JANSEN	
Forceps	61
Self Retaining Retractor	102
JANSEN-MIDDLETON Nasal Forceps	150
JAYES Osteotome	113
JENKINS Nasal Chisel	116
JOHNS-HOPKINS Bulldog Clamp	79
JOSEPH	
Elevator	122, 146
Knife	148, 164
Raspatory	146
Saw	148
Scissors	42
KAHN Facelift Scissors	34
KASDEN Retractor	98
KAYE Scissors	24-26, 36, 52
KAYE-FREEMAN Scissors	26, 27
KELLY Surgical Scissors	43
Keyboard	243, 245
KEYES Dermal Punch	156
KILLIAN	
Nasal Speculum	136
Septum Gouge	117
KILLIAN STANDARD Nasal Speculum	136
KILLIAN-CLAUS Septum Gouge	117
KILLIAN-COTTLE Nasal Speculum	138
KILLIAN-STRUYCKEN Sinus Nasal Speculum	139, 144
KILLIAN-WALTER Nasal Speculum	137
KILNER	
Hook	92
Needle Holder	86
Retractor	101
Scissors	124
KIRBY Fixation Forceps	61
KIRBY-BARRAQUER Fixation Forceps	64
KLAPPER TC CeraCut® Facelift Scissors	31
KLEINERT-KUTZ Skin Hook	93
KNAPP Fine Wound Retractor	94
Knife	
Button end Knife	164
Capsulotomy Knife	164
Cleft Palate	170
Mucosa Knife	164
Nasal Knife	148
Skin Graft Knife	165
Swivel Knife	148
KOCHER (DELICATE) Hemostatic Forceps	78
LAGRANGE Scissors	43
LAHEY	
Retractor	94
Scissors	39
LAMB Nasal Rasp	104
LAMONT Raspatory	108, 148
LANGENBECK Bone Holding Forceps	150
LAROE Undermining Forceps	209
Ligature Scissors	55
Light Cables	248
Light Source	246, 247

Description	Page
Lipo-Injection Dosing-Handle	236
Liposuction	
Cannulas	226-228
Hand Pieces	225
Instrument	229-234
LISTER Bandage Scissors	56
LITTLER Scissors	55
LOCKE Elevator	158
LOCKWOOD	
Abdominal Demarcator	80
Underminer	209
LOEFFLER Needle Holder	88
LOGAN Bow	172
LUCAE Dressing Aural Forceps	61
MACCOLLUM-DINGMAN Breast Dissector	213
MAGILL Suction Tube	222
MALINIAC Nasal Retractor	152
Mallet	125-126
MALTZ Nasal Rasp	104
Mammary Retractor	203, 204
Marker	215-220
Marking Pen	217
MARTEL Flap Grasping Forceps	80
MARTEN Flap Forceps	80
MARYLAND Micro Dissecting Forceps	185
MASING	
Osteotome	115
Retractor	97
Septum Elevator	147
MATARASSO Facelift Scissors	30
MATTHEW Osteotome	112
MAYO Surgical Scissors	50
MAYO-HEGAR Needle Holder	85
MAYO-STILLE Surgical Scissors	50
MCINDOE	
Forceps	66
Nasal Chisel	116
Nasal Rasp	108
MCKISSOCK (COLLEYR) Caliper	219
MCKISSOCK Breast Caliper	218
MEAD Mallet	126
MERCEDES Liposuction Cannula/ Instrument	227, 231
METZENBAUM Scissors	48, 54
METZENBAUM-FINO Scissors	49
METZENBAUM-FREEMAN Scissors	23, 31
MICRO-ADSON Forceps	60, 63, 65, 67, 70, 78
MICRO-HALSTEAD-MOSQUITO Forceps	79
Micro Scissors	185
MICRO-MOSQUITO Forceps	78
MILLARD	
Hook Forceps	64
Thimble Hook	101
MILLER Fine Wound Retractor	95
MINI OLSEN-HEGAR Needle Holder	83
MINI-GILLIES Needle Holder	86
MOBERG Wound and Skin Retractor	96
Monopolar Cable	76, 241
Monopolar Forceps	69-72
MONOPORT Liposuction Cannula/ Instrument	226, 230
MORRIS Retractor	208
Mucosa Knife	
Nail Instruments	159-163
Nasal Forceps	61, 123, 150
Nasal Instruments	145-154

Description	Page
Nasal Knife	148
Nasal Rasp	104-109, 123
Nasal Scissors	44-46
Nasal Speculum	127-144
Needle Holder	81-90, 123
NEGUS Suction Dissector	223
NEIVERT	
Nasal Retractor	98
Needle Holder	84
Neutral Electrode	241
NIRO Skin Hook	93
O'CONNOR Skin Hook	92
O'BRIEN Suture Scissors	55
OBWEGESER	
Elevator	146
Osteotome	114, 119
OBWEGESER-FREER Septum Elevator	147
OEHLER Tissue Forceps	68
OLSEN-HEGAR Needle Holder	85, 87
ORIGINAL MALTZ Nasal Rasp	106, 108
Osteotome	111-120, 122
PADDLE Facelift Scissors	28
PAR Needle Holder	83
PAR TYPE Scissors	36
PARKER-LANGENBECK (SET) Retractor US Army	208
PARKES Nasal Rasp	105
PECK-JOSEPH Scissors	42
PEET-COTTLE Nasal Rasp	106
Pen, Marking	217
PENN (HUMBY) Double Skin Hook	92
Periost / Periosteal Dissector	177, 178
Periost / Periosteal Elevator	122, 146, 170, 179
PIFFARD Lupus Curette	156
PITANGUY Flap Demarcator	80
Plate, Plastic	151
POTTS-SMITH	
Dressing Forceps	65
Monopolar Dressing Forceps	71
Vascular Scissors	56
RADOLF Nail extraction forceps	162
RAGNELL (KILNER) Scissors	40
RAGNELL Scissors	40
Rake Retractor	99, 100
RAMIREZ	
Endoforehead Corrugator	179
Flap Dissector	179
Rasp	
Ear	164
Nail	163
Nasal	103-110, 123
Raspatory	
Cleft Palate	171
Septum	146
Suction	223
other	148
READ	
Elevator	146
Nasal Gouge	117
REES	
Osteotome	112
Scissors	27, 28, 45
Retractor	
Abdominal Retractor	207
Abdominoplasty Retractor	210

Description	Page
Retractor	
Breast and Facial Retractor	205
Breast Retractor	190-203
Coronal Bow Retractor	210
Facelift Retractor	206
Mammary Retractor	203, 204
Nasal Retractor	98, 101, 123, 152, 153
Wound Retractor	91-102
REYNOLDS	
Breast Dissector	213
Scissors	40
REYNOLDS-JAMESON Scissors	54
Rhinoplasty Scissors	44-46, 124
Rongeur, Bone	149
ROSENBERG	
Skin Graft Mesher	166
Transplantat carrier	167
RÖTTGEN-RUSKIN Bone Rongeur	149
ROZNER Osteotome	113
RUBIN Osteotome	114
Ruler	218
RUSKIN-LISTON Bone Cutting Forceps	150
RYDER Needle Holder	84, 89
RYDER-VASCULAR Needle Holder	84
SAALFELD Comedo Extractor	157
SALYER	
Cleft Palate Dissector	171
Cleft Palate Elevator	171
Cleft Palate Hooklet	171
SAROT Needle Holder	87
Scalpel Handle	159, 180
SCHAMBERG Comedo Extractor	157
SCHINK Dermatome	165
SCHWALBENSCHWANZ Wound Retractor	95
Scissors	15-58
Bandage Scissors	56
Blepharoplasty Scissors	36, 52
Breast Dissection Scissors	45
Bulldog Scissors	45
Delicate Scissors	55
Dissecting Scissors	40, 42, 43, 48, 49, 54, 57, 124
Dorsal Scissors	44, 46
Facelift Scissors	20-35
Gum Scissors	36
Hook Scissors	181, 185
Ligature Scissors	55
Micro Hook Scissors	185
Micro Scissors	185
Nail Scissors	163
Nasal Scissors	44-46
Removal Scissors	51
Rhinoplasty Scissors	44-46, 124
Surgical Scissors	43, 50
Suture Scissors	55
Tenotomy Scissors	37, 38, 40, 51-53
Utility Scissors	57
Vascular Scissors	56
Vessel Scissors	54
Wire & Plate Scissors	56
SCULPO Breast Dissector	211-213
SEALY Scissors	43
SEMKEN Forceps	65, 67
SENNING Needle Holder	86, 88
Septum Elevator	147

Description	Page
SET	4-13, 109, 121-124, 156
SHAPER	173-182
Dissector	175-178
Elevator	175-178
Forceps	181
Hook Scissors	181
Nerve Hook	179
Nerve Protector	180
Sheath	174
Telescope	174
SHARK Liposuction Cannula/ Instrument	228, 234
SHEA Dissecting Scissors	43
SHEEHAN Osteotome	112
SHEEN Cartilage grid	217
SILVER	
Osteotome	115
Skin Graft Knife	165
SINUS Nasal Speculum	142
SISSON Wire Spring Retractor	102
Skin Graft (Board, Measure, Mesher, Knife)	165, 166
Skin Hook	92, 93, 122
Skin Retractor	96, 97
Speculum, Nasal	127-144
SPENCER Ligature Scissors	55
SPIRALE Liposuction Cannula/ Instrument	228, 233
SQUARE Fine Wound Retractor	94
ST. CLAIR THOMPSON Nasal Speculum	129
STACK Fork Retractor	96
STANDARD Dressing Forceps	65
STELLA Facelift Scissors	34
STENSTRØM	
Ear Rasp	164
Ear Scraper	164
STEVENS	
Forceps	60, 61
Scissors	37, 38, 51, 53, 54
STITCH Removal Scissors	52
STRABISMUS Scissors	39, 53, 54
Suction Cannula	222, 226-228
Suction Elevator	180, 223
Suction Instruments	221-238
Suction Tube	222
SULIVAN Monopolar Forceps	70
Suture Forceps	62
Suture Scissors	55
Swivel Knife	148
Syringe	235, 236
TC UNIVERSAL Wire & Plate Scissors	56
TEBBET STYLE Breast Retractor	194-199
Tenotomy Scissors	37, 38, 40, 51-53
TESSIER	
Osteotome	118
Scissors	31
THORPE Caliper	218
THUDICHUM (MARK HOVELL) Nasal Speculum	128
TICKNER Forceps	66
Tissue Forceps	61-64, 67, 68, 70, 71, 79, 124
TITAN ADSON Forceps	68
TITAN ADSON-BROWN Forceps	68
TITAN GILLIES Forceps	68
TOENNIS-ADSON Scissors	49
TOLSDORF Bone Crusher	151
TRIPORT Liposuction Cannula/ Instrument	226, 229
UNNA Comedo Extractor	157

Description	Page
VAN SICKLE Rake Retractor	100
WALDEN-MARSHALL Breast Dissection Scissors	57
WALDRAM Scissors	53
WALTER	
Chisel	117
Nasal Speculum	137
Osteotome	112
Scissors	124
WALTON	
Comedone Extractor	157, 159
Tenotomy Scissors	52
WARD	
Osteotome	113
Periosteal Elevator	146
WATSON-WILLIAMS Nasal Rasp	109
WEBSTER Needle Holder	84
WEITLANER-LOKTITE Self Retaining Retractor	102
WIENER Breast & Facial Retractor	206
WIENER MODELL Nasal Speculum	130
WILMER Utility Scissors	45
Wire Brush for cleaning Rasps	109
Wire Holding Forceps	87
Wound Retractor	91-102
YANCOSKIE Abdominoplasty Retractor	210
YANKAUER Suction Cannula	222